



WAVERLEY  
COUNCIL

**WAVERLEY DEVELOPMENT**

**CONTROL PLAN 2022**



## **Waverley Council**

Mail: PO Box 9  
Bondi Junction NSW 1355  
Phone: (02) 9083 8000 (General Enquiries)  
Email: [info@waverley.nsw.gov.au](mailto:info@waverley.nsw.gov.au)  
Website: [www.waverley.nsw.gov.au](http://www.waverley.nsw.gov.au)

Waverley Development Control Plan 2022 is published by Waverley Council.



## TABLE OF CONTENTS

<b>Part A</b>	<b>Preliminary Information</b>	
<b>A1</b>	Statutory Information	1
<b>Part B</b>	<b>General Provisions</b>	
<b>B1</b>	Waste	4
<b>B2</b>	Ecologically Sustainable Development	15
<b>B3</b>	Landscaping, Biodiversity and Vegetation Preservation	27
<b>B4</b>	Coastal Risk Management	40
<b>B5</b>	Water Management	41
<b>B6</b>	Accessibility and Adaptability	53
<b>B7</b>	Transport	58
<b>B8</b>	Heritage	76
<b>B9</b>	Safety	104
<b>B10</b>	Public Art	106
<b>B11</b>	Design Excellence	107
<b>B12</b>	Subdivision	109
<b>B13</b>	Excavation	111
<b>B14</b>	Advertising and Signage	114
<b>B15</b>	Public Domain	125
<b>B16</b>	Inter-War Buildings	136
<b>B17</b>	Social Impact Assessment	140
	Annexures	132
<b>Part C</b>	<b>Residential Development</b>	
	General Notes	181
<b>C1</b>	Low Density Residential Development	182
<b>C2</b>	Other Residential Development	214
<b>Part D</b>	<b>Commercial Development</b>	
<b>D1</b>	Commercial and Retail Development	245
<b>D2</b>	Outdoor Dining	252
	Annexures	269
<b>Part E</b>	<b>Site Specific Development</b>	
<b>E1</b>	Bondi Junction Centre	272
<b>E2</b>	Bondi Beachfront Area	326
<b>E3</b>	Local Village Centres	349
<b>E4</b>	Special Character Areas	384
<b>E5</b>	113 Macpherson Street, Bronte	390
<b>E6</b>	194-214 Oxford Street, 2 Nelson Street and Osmund Lane, Bondi Junction	396
<b>E7</b>	Edina Estate	405
	<b>Annexures</b>	424



# TABLE OF CONTENTS

<b>Part F</b>	<b>Development Specific</b>	
<b>F1</b>	Shared Accommodation	483
<b>F2</b>	Tourist and Visitor Accommodation	485
<b>F3</b>	Child Care Centres	489
<b>F4</b>	Places of Public Worship	490
<b>F5</b>	Horticulture	496
	<b>Definitions and Abbreviations</b>	497



## AMENDMENT HISTORY

Amendment No.	Date of Adoption	Date of Effect	Amendment Description
0	06 12 2022	08 12 2022	Establishment of this DCP.
1	01 08 2023	18 08 2023	Introduction of new Part E7 – Edina Estate
2	19 03 2024	1 05 2024	<b>Updates to B5.2 Flood Planning</b>



# PART A PRELIMINARY INFORMATION

## CONTENTS

<b>A1</b>	<b>STATUTORY INFORMATION .....</b>	<b>1</b>
1.1	Commencement.....	1
1.2	Land to which this DCP applies .....	1
1.3	Purpose .....	1
1.4	Relationship with other plans, standards and codes .....	1
1.5	Compliance.....	2
1.6	Savings provision.....	2
1.7	Offences .....	2
1.8	Structure.....	3

## A1 STATUTORY INFORMATION

This Development Control Plan is referred to as *Waverley Development Control Plan 2022* (WDCP). The WDCP has been prepared in accordance with the *Environmental Planning and Assessment Act 1979* (EP&A Act) and *Environmental Planning and Assessment Regulation 2021* (EP&A Regulation).

### 1.1 COMMENCEMENT

This DCP was adopted by Council on 6 December 2022 and came into force on 8 December 2022.

### 1.2 LAND TO WHICH THIS DCP APPLIES

This DCP applies to all land within the Waverley Council Local Government Area (LGA).

### 1.3 PURPOSE

This DCP provides strategies, objectives and development guidelines for the assessment of Development Applications (DA) and complements the provisions of the *Waverley Local Environmental Plan* (WLEP).

### 1.4 RELATIONSHIP WITH OTHER PLANS, STANDARDS AND CODES

This DCP should be read in conjunction with WLEP. Where there is an inconsistency between this Plan and the WLEP, the LEP prevails. This DCP is also to be read in conjunction with the following:

- *Environmental Planning & Assessment Act 1979*;
- *Environmental Planning & Assessment Regulation 2021*;
- *Local Government Act 1993*;
- *Roads Act 1993*;
- Any relevant State Environmental Planning Policy (SEPP);
- Any relevant Land and Environment Court Planning Principle;
- National Construction Code and Building Code of Australia;
- Any relevant Australian Standard (identified or not in this Plan);
- Any policy or guideline adopted by Council including:
  - Waverley Local Strategic Planning Statement (LSPS). \_
  - Creative Lighting Strategy Parts 1 and 2
  - Our Liveable Places Centres Strategy.
  - Local Housing Strategy.
  - Public Domain Technical Manual.
  - Development Contributions Plan.
  - Planning Agreement Policy.
  - Tree and Vegetation Vandalism Policy
  - Tree Management Policy.
  - Heritage Policy.
  - Public Art in the Private Domain.
  - Inter-War Factsheets.



- Water Management Technical Manual.

It is the responsibility of the applicant to identify all relevant legislative requirements. The NSW Legislation website should be regularly checked for the most up-to-date version of all legislation and can be accessed at: [www.legislation.nsw.gov.au](http://www.legislation.nsw.gov.au)

## **1.5 COMPLIANCE**

Section 4.15 of the *EP&A Act* requires Council to take this DCP into consideration when determining applications. Compliance with the provisions of this DCP does not necessarily guarantee that consent to a DA will be granted. Each DA will be assessed having regard to the current LEP, DCP, adopted Council policies, State Environmental Planning Policies, and any other matters listed in Section 4.15 of the *EP&A Act*.

## **1.6 SAVINGS PROVISION**

If an application has been made before the commencement of WDCP, but not finally determined, the development application must be determined as if WDCP had not commenced.

All applications made after the commencement date of an amendment to the WDCP are subject to WDCP as amended at the date of lodgement.

Please refer to the Amendment History at the front of WDCP for relevant commencement dates.

A reference to an application in the paragraph above is a reference to:

- a development application;
- an application to modify a development consent;
- an application to review a determination of a development application; or
- an application to review an application to modify a development consent.

## **1.7 OFFENCES**

Sections 9.37 and 9.50 of the *EP&A Act* provides that where any matter or thing is by or under this Act or Regulation directed or forbidden to be done, a person offending against that direction or prohibition shall be guilty of an offence against this Act.

**1.8 STRUCTURE**

<b>PART A</b> Preliminary Information	Describes the purpose and structure of the DCP. Advertising and notification requirements are now addressed in the <i>Community Participation Plan</i> available on Council’s website.
<b>PART B</b> General Provisions	Provides controls that relate to all development and land including environmental protection, heritage, design excellence, advertising and signage, public art, the public domain, transport and parking, accessibility and safety.
<b>PART C</b> Residential Development	Provides controls for residential development including new and alterations and additions to single and dual occupancy development and multi dwelling housing, residential flat buildings and the residential component of shop top housing.
<b>PART D</b> Commercial Development	Provides controls for commercial development including restricted premises, and footpath seating for restaurants and cafes.
<b>PART E</b> Site Specific Development	Provides specific controls for development located within Bondi Junction, Bondi Beach and Waverley’s other commercial centres known as Local Village Centres.
<b>PART F</b> Development Specific	Provides controls on specific development types including shared accommodation, tourist and visitor accommodation, places of public worship and horticulture
Definitions & Abbreviations	Defines terms and abbreviations used in this DCP that are not defined by either the <i>EP&amp;A Act</i> or the <i>WLEP</i> .

# **PART B**                    **GENERAL PROVISIONS**

## **Contents**

<b>B1 WASTE</b>	<b>4</b>
1.1 Demolition and Construction	4
1.2 Ongoing Management	6
1.3 Low density Residential Development	7
1.4 All Other Development	8
<b>B2 ECOLOGICALLY SUSTAINABLE DEVELOPMENT</b>	<b>15</b>
2.1 Passive Design and Thermal Safety	17
2.2 Water Conservation	19
2.3 Indoor Air Quality	20
2.4 Renewable Energy and Energy Efficiency	21
2.5 Energy Assessment	24
2.6 Nabers Commitment Agreement	25
<b>B3 LANDSCAPING, BIODIVERSITY AND VEGETATION PRESERVATION</b>	<b>27</b>
3.1 General Provisions	27
3.2 Landscaping	30
3.3 Biodiversity	35
3.4 Protecting Trees on Development Sites	38
3.5 Penalties	38
<b>B4 COASTAL RISK MANAGEMENT</b>	<b>40</b>
<b>B5 WATER MANAGEMENT</b>	<b>41</b>
5.1 Stormwater Management and WSUD	41
5.2 Flood Planning	43
<b>B6 ACCESSIBILITY AND ADAPTABILITY</b>	<b>53</b>
6.1 Accessibility	54
6.2 Adaptable Dwellings	55
6.3 Universal Housing Design	56
6.4 Unjustifiable Hardship	57
<b>B7 TRANSPORT</b>	<b>58</b>
7.1 Streetscape	59
7.2 On-Site Parking	60
7.3 Loading Facilities	69
7.4 Pedestrian/Bicycle Circulation and Safety	70
7.5 Green Travel Plans	71
7.6 Traffic and Transport Management Plans	72
7.7 Car Share	73
7.8 Electric Vehicle Charging Points	74
<b>B8 HERITAGE</b>	<b>76</b>
8.1 Defining Heritage	77
8.2 Demolition & Excavation	79
8.3 Aboriginal Sites	80



8.4 Heritage Conservation Areas	83
8.5 Landscape Conservation Areas	84
8.6 Character and Streetscape	85
8.7 Siting	87
8.8 Scale and Proportion	88
8.9 Architectural style	90
8.10 Materials and colour	91
8.11 Roofs and Chimneys	92
8.12 Verandahs and Balconies	93
8.13 Garages, Parking and Site Access	94
8.14 Garden Elements	95
8.15 Building Facades	96
8.16 Detailing	97
8.17 Fencing and Gates	98
8.18 Landscaping	100
8.19 Commercial Properties	101
<b>B9 SAFETY</b>	<b>104</b>
9.1 Built Form	104
<b>B10 PUBLIC ART</b>	<b>106</b>
10.1 Public Art in the Private Domain	106
<b>B11 DESIGN EXCELLENCE</b>	<b>107</b>
11.1 Design	107
11.2 Context Analysis	108
<b>B12 SUBDIVISION</b>	<b>109</b>
<b>B13 EXCAVATION</b>	<b>111</b>
<b>B14 ADVERTISING AND SIGNAGE</b>	<b>114</b>
14.1 Design and Location	114
14.2 Site Specific Controls	117
14.3 Sign Specific Controls	121
<b>B15 PUBLIC DOMAIN</b>	<b>125</b>
15.1 Improving the Public Domain	125
15.2 Active Street Frontages	127
15.3 Arcades and Through Site Links	130
15.4 Awnings and Colonnades	132
15.5 Reflectivity	133
15.6 Shopfront Security	134
15.7 Minor Encroachments	135
<b>B16 INTER-WAR BUILDINGS</b>	<b>136</b>
<b>B17 SOCIAL IMPACT ASSESSMENT</b>	<b>140</b>
<b>ANNEXURES</b>	<b>150</b>

## B1 WASTE

This Part applies to all works requiring a development application (DA) and is to be read in conjunction with Council's relevant policies and guidelines.

### General Objectives

- (a) To support the delivery of the targets and outcomes of the *Environmental Action Plan, the Waste and Sustainable Materials Strategy 2020-2041* and the *Waste Avoidance and Resource Recovery Act 2001*.
- (b) To reduce the amount of waste generated and maximise resource recovery during the demolition, construction and ongoing management of a property.
- (c) To facilitate safe and efficient waste and recycling collection from all premises.
- (d) To ensure waste management, removal and disposal is in accordance with the relevant State Government Legislation.
- (e) To support innovative and circular solutions for avoiding waste to landfill in the built environment
- (f) Minimise ongoing operational waste management costs to property owners, occupants, and the Council
- (g) Minimise developments' waste management and collection service impacts on occupants and surrounding areas
- (h) Reduce other impacts on occupants and surrounding areas related to waste management such as traffic congestion, truck movements, greenhouse gas emissions, noise from frequent collections.

### General Controls

- (a) The *Site Waste & Recycling Management Plan (SWRMP)* is to be submitted in accordance with the *Waverley Development Application Guide*.

## 1.1 DEMOLITION AND CONSTRUCTION

### Objectives

- (a) Avoid creating construction waste wherever possible
- (b) To maximise the re-use of clean excavated material, sandstone, concrete, bricks and timber.
- (c) To minimise the amount of construction waste that is sent to landfill
- (d) To increase efficiency of development and encourage sustainable practices.
- (e) To ensure the safe removal and disposal of hazardous building materials.

### Controls

- (a) A construction waste storage area is to be located within the property boundary and is to be identified on the site plans as part of the *SWRMP*.
- (b) Separate construction waste collection bins *or* construction waste storage areas are to be provided giving consideration to slope, drainage, vegetation, access and handling requirements and may include:
  - (i) Landfill waste;
  - (ii) Recyclable waste;
  - (iii) Materials to be re-used on-site; and / or

- (iv) Excavation materials (refer to *Annexure B1-1* for common building materials that can be re-used and recycled).
- (c) Waste that can be recycled or reclaimed is to be identified in the SWRMP, as well as the intended methods for recovery and reclamation.
- (d) All sandstone must be re-used on site or reclaimed through an appropriate contractor.
- (e) Asbestos and other hazardous material is to be managed under the *Protection of the Environment Operations Act 1997*, in accordance with the provisions of Safe Work NSW, and Council's Asbestos Policy.
- (f) Materials that cannot be reused or recycled must be:
  - (i) Disposed of at a State Government approved facility and specified in the SWRMP; and
  - (ii) Disposed of via a contractor that operates in accordance with the Proximity Principle outlined in State Government Legislation.
- (g) Records are to be retained on-site demonstrating lawful disposal of waste.
- (h) Easy vehicular access to waste and recycling material storage areas must be provided and detailed in the SWRMP.
- (i) Construction materials are to be stored away from waste and recycling materials to enable easy access for waste collectors. Skip bins are to be utilised and located in accordance with Council's building waste and hoardings policy.
- (j) All materials are to be stored in way that:
  - (i) Prevents damage from the elements, and reduces odour, health risks and windborne litter; and
  - (ii) Prevents impacts to the environment under State Government Legislation (including stormwater pollution and runoff).



## 1.2 ONGOING MANAGEMENT

### Objectives

- (a) To ensure new developments and changes to existing developments are designed to minimise waste generation and maximize resource recovery.
- (b) To encourage waste storage facilities that are designed to enable source separation for recovery
- (c) To ensure waste and recycling systems are easy to use and complement Council's waste and recycling services.
- (d) To promote safe practices for storage, handling and collection of waste and recycling.
- (e) To prevent stormwater pollution that may result from poor waste and recycling storage and management practices.
- (f) To ensure waste storage areas have sufficient volume, are easily accessible, safe, hygienic and are aesthetically incorporated into the design of the development.
- (g) To prevent impacts to the environment that may result from litter, excess waste and illegal dumping.
- (h) To minimise impacts of waste and waste bins presented on public land for collection on pedestrian and vehicle access, safety and amenity
- (i) To provide flexibility to expand or reconfigure waste separation systems, so that owners and occupants have options to access a range of waste services

### Controls

- (a) Development for the purposes of any of the following must comply with Part B1.3:
  - Dwelling houses;
  - Dual occupancies;
  - Secondary dwellings;
  - Semi-detached dwellings;
  - Attached dwellings;
  - Multi-dwelling housing.
- (b) Development for the purposes of any of the following must comply with Part B1.4:
  - All other residential accommodation not listed in (a) above;
  - Tourist and visitor accommodation;
  - Commercial development; and
  - Any other development not listed in (a).

### 1.3 LOW DENSITY RESIDENTIAL DEVELOPMENT

This section applies to development for the purposes of Dwelling houses; Dual occupancies; Secondary dwellings; Semi-detached dwellings; and/or Attached dwellings.

#### 1.3.1 General Controls

- (a) Details of ongoing waste management strategy are to be documented within a *Site Waste & Recycling Management Plan (SWRMP)*.
- (b) A waste and recycling storage area for each dwelling must be located on the relevant lot in a position convenient for both users and waste collection personnel.
- (c) Sufficient space must be provided to accommodate the storage of waste and recycling likely to be generated on the premises between collections and any associated equipment.
- (d) Waste and recycling receptacles must be stored at all times within the boundary of the site and screened from the public and commercial domains unless otherwise approved by Council under Section 68 of the *Local Government Act 1993*.
- (e) All waste and recycling must be inside Council approved bins or skips, with lids closed to reduce littering, stormwater pollution, odour and vermin. Waste and recycling not presented in the correct manner will not be collected.
- (f) Council will supply and service 140L and 240L bins.
- (g) Organic waste should be either treated in a composting or worm farming system or stored in a Council approved bin or skip (refer to Annexure B1-5).
- (h) Incineration devices are not permitted.

#### 1.3.2 Amenity

- (a) Waste and recycling storage areas must be visually and physically integrated into the design of the development.
- (b) Waste and recycling storage areas must be designed and located to avoid adverse impacts on the amenity of adjoining sites including noise, odour and visual impacts.
- (c) All waste and recycling receptacles must be put out for kerb-side collection no earlier than the previous evening.
- (d) All waste and recycling receptacles must be removed from the kerb-side or laneway as soon as possible on the same day as the collection service.

#### 1.3.3 Ongoing Management

- (a) Ongoing management of the property is to be in accordance with the approved SWRMP to ensure that appropriate waste and recycling services are provided.
- (b) Waste generated by a development must not exceed the maximum permitted generation rates for the building use.

## 1.4 ALL OTHER DEVELOPMENT

This section applies to development for the purposes of the following: all residential accommodation not affected by *1.3 Low Density Residential Development* above; Tourist and visitor accommodation; Commercial development; and/or any other development.

Please note that:

- Backpacker accommodation is a commercial property use and requires a commercial waste service.
- Boarding houses/time shares/co-living housing, serviced apartments, retirement village, and independent living are residential uses and require a domestic waste service, incurring a Domestic Waste Charge.

### 1.4.1 Waste Storage Areas

#### 1.4.1.1 GENERAL CONTROLS

- (a) Details of ongoing waste management strategy are to be documented within the SWRMP and reviewed every 5 years to employ updated waste reduction strategies and technologies.
- (b) Sufficient space must be provided to accommodate the storage of waste and recycling likely to be generated on the premises between collections and any associated equipment. Minimum waste and recycling generation rates for various commercial and residential developments are provided in Annexure B1-2.
- (c) Ensure bins can be placed side-by-side (no stacking).
- (d) Bin-carting route from the storage area to the collection point is safe and convenient with no steps or steep gradients.
- (e) Waste storage rooms or areas are to be easily accessible (<30 m from collection point).
- (f) Waste rooms are not to be used for any purpose other than the storage of waste and/or waste infrastructure.
- (g) Where a door or gate opens inwards, no bins are stored within the arc of the swinging door. Where a door or gate opens outwards, the gate does not block the pathway for moving bins out to the collection point.
- (h) Waste and recycling receptacles must be stored at all times within the boundary of the site and concealed from the public and commercial domains unless otherwise approved by Council under Section 68 of the *Local Government Act 1993*.
- (i) All waste and recycling must be inside Council approved bins or skips, with lids closed to reduce littering, stormwater pollution, odour and vermin. Waste and recycling not presented in the correct manner will not be collected.
- (j) Council will supply and service 140L, 240L and 660L bins. The use of 660L bins will only be considered where:
  - (i) The collection point has enough space to present 660L bins without impacting pedestrian access to the footpath and/or driveway of the development;
  - (ii) The collection point is level; and,
  - (iii) Council waste collection vehicle can access the collection point either within the property boundary or at the kerb-side and the collection point meets requirements in Annexure B1-3.



- (k) For developments with 20 dwellings or more, or mixed use developments with more than 200sqm of commercial floor space and a minimum of 10 residential dwellings, advice must be obtained from a waste management consultant to incorporate optimal waste storage and management solutions that recover as much material as possible. Such solutions can be in the form of compactors, chute systems, and/or problem waste storage and collections. Strategies for waste minimisation, and the reduction of waste storage space are to be outlined in the SWRMP.
- (l) Additional space in the bin room is required for waste compactors, chutes, and other infrastructure to easily manoeuvre bins.
- (m) Any volume reducing equipment must be installed in accordance with the manufacturers design specifications and have a space between the unit and the walls to enable easy access for cleaning and maintenance. Compaction rates must not be set higher than 2:1.
- (n) Organic waste should be either treated in a composting or worm farming system or stored in a Council approved bin or skip (refer to Annexure B1-5).
- (o) Incineration devices are not permitted.
- (p) Waste and recycling storage rooms must be:
  - (i) Enclosed to prevent noise, odour and visual impacts;
  - (ii) Designed to store the entire fleet of bins plus 0.2m between bins to allow adequate manoeuvrability;
  - (iii) Designed with a 1.8m unobstructed clearance zone between the stored bins and the entrance for access and manoeuvrability;
  - (iv) Designed with suitable door and corridor access to enable bin movement;
  - (v) Constructed of concrete or other approved materials at least 75mm thick;
  - (vi) Finished with a smooth even surface to be easily cleaned;
  - (vii) Coved at the intersection with walls and plinths with a ramp to the doorway where necessary;
  - (viii) Graded and drained to the sewerage system and approved by Sydney Water;
  - (ix) Fitted with a close fitting and self-closing door that can be opened from within the room;
  - (x) Designed with adequate lighting and natural/mechanical ventilation;
  - (xi) Fitted with smoke detectors in accordance with the relevant Australian Standards.
  - (xii) Equipped taps supplying hot and cold water, mixed through a centralised mixing valve with a hose cock and fitted with an aerator to increase water efficiency;
  - (xiii) Designed to include a clear and easy-to-read “NO STOPPING” sign and “DANGER” sign on the external face of waste storage rooms where appropriate;
  - (xiv) Designed to ensure waste-water from the cleaning of the waste storage area and bins, is not to drain into the stormwater system; and
  - (xv) Fitted with childproof compactors or mechanical devices where used in the storage of waste.

## 1.4.1.2

#### ADDITIONAL CONTROLS RELATING TO RESIDENTIAL COMPONENTS OF DEVELOPMENT

- (a) A room or caged area with a minimum floor space of 4m<sup>2</sup> must be provided for the storage of discarded bulky items, awaiting collection. The doorway of this storage area must be at least 1.5m. The following minimum floor space requirements apply:
  - (i) Between 6 and 20 units: 4m<sup>2</sup>
  - (ii) Between 21 and 40 units: 4m<sup>2</sup> +1m<sup>2</sup> for every 10 additional units above 20 units
  - (iii) Between 41 and 100 units: 8m<sup>2</sup> + 1m<sup>2</sup> per 20 additional units above 40 units
  - (iv) Over 101 units: 12m<sup>2</sup> +1m<sup>2</sup> per 50 additional units above 100 units
- (b) Additional space is required for recycling problem waste such as textiles or electronic waste. The minimum floor space required is 1 m<sup>2</sup> per 50 units to a maximum 2m<sup>2</sup>. This space should be within or attached to the waste storage area.
- (c) Developments containing more than 3 habitable storeys must:
  - (i) Provide a system for convenient transportation of waste and recyclable material to the communal waste and recycling storage area; Provide a waste and recycling compartment/area on each floor with sufficient capacity to store at least 1 day volume of waste and recycling likely to be generated on that floor; and
  - (ii) Where a chute system is provided, both waste chute and recycling bins must be stored together in an allocated communal waste and recycling area on each floor.
- (d) Waste, recycling and garden organics receptacles must be stored at all times within a building in a designated storage room. Exceptions can be made:
  - (i) Where storage space is available at the side or back of the building, away from public accessibility, and the area can be screened from public and commercial domains; or
  - (ii) Where the storage area at the front of the property is completely enclosed with no risk of public accessibility.
  - (iii) If a waste storage area is outside of the building, the design must complement the primary building and the storage location must be >1m from windows and balconies.

1.4.1.3 ADDITIONAL CONTROLS RELATING TO COMMERCIAL COMPONENTS OF DEVELOPMENT

- (a) All new developments are to provide adequate storage for waste to accommodate future change of use, including increased waste generation rates and grease traps.
- (b) If the commercial use of the property is undecided, minimum waste and recycling generation rates must be applied as per Annexure B1-2.
- (c) Kitchens, office tea rooms, and the like are to be designed with sufficient space for the interim storage of recyclable, organic and general waste in separate receptacles.
- (d) A waste service compartment (waste and recycling area) is to be provided on each floor of the building and have sufficient capacity to store at least 1 day's volume of waste and recycling likely to be generated on that floor.
- (e) A minimum of 2m<sup>2</sup> floor space for developments under 100m<sup>2</sup> and 4m<sup>2</sup> floor space for developments over 100m<sup>2</sup> must be allocated within the building for the storage of reusable items such as crates and pallets, and bulk waste such as cardboard or soft plastics.

- (f) Separate space must be allocated for the storage of trade wastewater (within the building where applicable). Trade wastewater must be managed in accordance with a Sydney Water permit and any pre-treatment equipment such as grease traps must meet Australian standards and be properly installed and maintained.
- (g) Liquid waste from grease traps must only be removed by licensed contractors approved by Sydney Water and NSW EPA.
- (h) Waste cooking oil must be stored in sealed containers and stored in a bunded area (an area where leaking oil can't escape). Space must be allocated to store the waste cooking oil and the location must be in an area easily accessible to the oil recycler for servicing.
- (i) For commercial premises that generate 20% or more food waste, or other waste which is considered by Council to have potential amenity impacts, a daily waste collection is required, unless an alternative is agreed upon with Council.
- (j) For premises that use 660L bins or larger bins, the bins must be lockable and have wheels with working brakes.
- (k) All commercial kitchens in cafes and restaurants or similar must include space for a dishwasher to ensure plates, cutlery and crockery can be washed to reduce reliance on single use items.

#### 1.4.1.4 ADDITIONAL CONTROLS RELATING TO ALL MIXED-USE DEVELOPMENT

- (a) In addition to the relevant application of controls from B1.3.3, this section also applies to any mixed use development.
- (b) There must be at least two separate waste and recycling storage rooms or areas, one for commercial waste and recycling, and one for residential waste and recycling. Storage rooms are to be self-contained and have separate keys and locking systems. A separate bulky waste storage room is also to be provided for residents that is inaccessible to commercial premises.
- (c) Mixed-use developments that require the equivalent of 20 x 240L of Mobile Garbage Bins to store their waste and recycling must organise onsite collection or a wheel in/out service.

### 1.4.2 Access and Collection

#### 1.4.2.1 GENERAL CONTROLS

- (a) Waste and recycling storage areas must be located in a position convenient for both users and waste collection personnel.
- (b) The path for bins between the waste and recycling storage area and the vehicle collection point must be free of steps, narrow gates, vegetation, stepping-stones, loose material, and kerbs.  
Multi-residential and mixed-use development with more than 20 residential units must accommodate an on-site domestic waste collection service.
- (c) Access roads must comply with the Building Code of Australia, all relevant Australian Standards and *Annexure B1-3*.

#### 1.4.2.2 ADDITIONAL CONTROLS RELATING TO ON SITE WASTE COLLECTION

- (a) On-site waste collection is to be accommodated within a basement or at grade within the building from a dedicated collection point or loading bay that does not impede pedestrian, cycleway, or vehicle movement.
- (b) The on-site waste collection must be designed to allow collection vehicles to enter and exit the property in a forward direction and must have adequate vehicle clearance. Exceptions may be considered where the collection vehicle can back into a driveway safely without impeding pedestrian or vehicle access.
- (c) The on-site waste collection loading point is to comply with the provisions of *Annexure B1-3*.
- (d) The on-site waste collection point may be the same as, or separate to, the waste storage room. Unimpeded and level access is to be provided between the waste collection point and the loading bay.
- (e) The on-site waste collection point is to be of a sufficient size to store all bins to be collected without interruption to the functioning of the development.
- (f) The on-site waste collection point must include a bulky household waste collection point separate (or next to) to the bin collection point..

#### 1.4.2.3 ADDITIONAL CONTROLS RELATING TO WHEEL-IN AND WHEEL-OUT COLLECTION SERVICE

A wheel-in and wheel out service is subject to approval by Council and will only be approved where on-site collection is deemed not feasible for the premises. Council will consider providing wheel-in, wheel-out collection service for residential bins and bulky household waste under the following (but not limited to) circumstances:

- (d) The presentation of the bins at the property would impact on pedestrian access or other safety issues;
- (e) A roller door or similar to access the bin room or a temporary holding area is available on the boundary of the property where the bins would be collected from;
- (f) There is a maximum of 8m between the designated Council waste collection vehicle access point and designated collection point;
- (g) Collection point is accessible from the street, including from a driveway or a designated parking area;
- (h) The waste collection point does not impede traffic or pedestrian flow whilst engaged in the collection of bins/bulky waste;
- (i) Council waste collection vehicle access is available either within the property boundary or street access and meets requirements in Annexure B1-3; and,
- (j) The path for bins between the designated bin storage area and the vehicle collection point must have a flat surface and be free of steps, narrow gates, vegetation, stepping-stones, and loose material.



---

### 1.4.3 Amenity

---

#### 1.4.3.1 GENERAL

- (a) Waste and recycling storage areas must be visually and physically integrated into the design of the development.
- (b) Waste and recycling storage areas must be designed and located to avoid adverse impacts on the amenity of adjoining sites including noise, odour and visual impacts.
- (c) All waste and recycling receptacles must be put out for kerb-side collection no earlier than the previous evening.
- (d) All waste and recycling receptacles must be removed from the kerb-side or laneway as soon as possible on the same day as the collection service.

---

### 1.4.4 Management

---

#### 1.4.4.1 GENERAL CONTROLS

- (a) A current copy of the approved SWRMP is to be stored on site and available at all times.
- (b) Ongoing management of the property is to be in accordance with the approved SWRMP to ensure that appropriate waste and recycling services are provided.
- (c) Waste generated by a development must not exceed the maximum permitted generation rates for the building use.
- (d) Where a change of use, change of tenant or change in waste management practices will result in a variation to the SWRMP, an application is to be made to Council to revise the approved SWRMP.
- (e) The SWRMP must identify responsibility for:
  - (i) cleaning of waste receptacles and storage areas
  - (ii) for transfer of bins within the property, to the collection point and back to the storage areas.
  - (iii) regular monitoring of bins for contamination and educating residents on how to use the waste and recycling services
  - (iv) inspect, maintain and repair all waste management equipment, such as chutes, bin lifts, compactors and other equipment
  - (v) liaising with the council or the collection contractor on waste management issues and service requests.
- (f) Clear and easy to read signs identifying the different waste receptacles and where in the storage area these should be positioned must be displayed.
- (g) The building manager or owner's corporation is to review every 5 years the methods for waste storage, treatment and collection and implement any relevant changes to reduce waste and increase recycling.

---

#### 1.4.4.2 ADDITIONAL CONTROLS RELATING TO COMMERCIAL COMPONENTS OF DEVELOPMENT

- (a) All businesses must have written evidence, held on site, of a valid and current contract with a licensed collector of waste and recycling.

- (b) The waste and recycling management (including composting) and collection system, along with allocated responsibilities should be clearly outlined in contracts with cleaners, building managers and tenants and included in the SWRMP.

## B2 ECOLOGICALLY SUSTAINABLE DEVELOPMENT

This Part applies to all development in the Waverley LGA.

Waverley Council is committed to the highest standards of environmental performance and stewardship of our local area. Council has established long-term environmental targets for Council and Community, covering greenhouse emissions, transport, climate resilience, urban ecology, water management and the sustainable management of waste and materials. Our targets are informed by the best available science and support Ecologically Sustainable Development (ESD) through the following objectives:

- Reducing greenhouse gas emissions to net zero;
- Increasing the use of renewable energy sources;
- Conserving water resources;
- Reducing reliance on mains water supply through the collection and treatment of rainwater and greywater;
- Adapting and responding to climate change to reduce community vulnerability to local climate change impacts and managing climate risks;
- Reducing waste during construction and the ongoing use of the building;
- Increasing recycling of waste and use of recycled products;
- Reducing the environmental impact from building materials through the reduction, re-use and recycling of materials, resources and building components;
- Protecting and improving local biodiversity of sites and surrounding areas.

### Residential Development and BASIX

*State Environmental Planning Policy (Building Sustainable Index: BASIX) 2004* applies to residential developments only and aims to ensure homes or apartments are designed to minimise potable water usage and energy usage.

An applicant is required to lodge a BASIX certificate with their development application with Council for:

- New residential buildings;
- Alterations and additions to existing residential buildings where the estimated construction cost of the work is more than \$50,000 and where development approval is required; and
- New swimming pool (or pool and spa) with a capacity of 40,000 litres or more.

More information is available at the following link: [www.basix.nsw.gov.au](http://www.basix.nsw.gov.au).

### Mandatory Commercial Building Disclosure

In 2010 the Australian Government implemented a Mandatory Commercial Building Disclosure program under the [Building Energy Efficiency Disclosure Act \(2010\)](#). This program applies to commercial buildings with a net lettable floor area of 1,000sqm or more, and requires owners to disclose energy efficiency information to purchasers and lessees when the space is to be sold, leased or subleased. More information is available from the Australian Government's Department of Industry, Science, Energy and Resources (or equivalent).

### Objectives

- (a) To encourage applicants to apply principles and processes that contribute to ecologically sustainable development (ESD) in Waverley.
- (b) To ensure that the design, construction and operation of development minimises adverse impacts on the natural and built environment.
- (c) To improve the quality of life, health and wellbeing of residents and workers.
- (d) To ensure that all development will reduce water consumption and can reduce greenhouse gas emissions to net zero.
- (e) To encourage the replacement of intensive carbon power sources with low carbon and renewable energy.
- (f) To improve indoor air quality.
- (g) To ensure that waste will be reduced and to increase the use of products from recycled sources
- (h) To reduce the environmental impact from building materials through reduction, re-use and recycling of materials, resources and building components
- (i) To reduce urban heat island effect by maintaining and increasing tree canopy, permeable surfaces and deep soil.
- (j) To reduce greenhouse gas emissions from the construction of developments.
- (k) To respond to and prepare for changes in the climate and resource consumption.
- (l) To ensure that development can adapt to climate change.
- (m) To improve local biodiversity.
- (n) To accommodate changing technologies in the design of developments that will provide sustainability outcomes in the built environment for future users.

### Controls

- 1) A Statement of Environmental Effects is required to outline how the objectives of ecologically sustainable development will be achieved

**2.1 PASSIVE DESIGN AND THERMAL SAFETY**

Passive buildings are designed so that windows, walls, and floors are able to collect, store, and distribute solar energy in the form of heat in winter and reject solar heat in the summer. A passively designed house reduces the need for the use of mechanical and electrical (active heating and cooling) systems, saving energy and costs. For more information on passive design refer to: <http://www.yourhome.gov.au/passive-design>

With global warming temperatures predicted to increase a minimum of 1.5 degrees by 2030, Waverley Council is working to ensure that all new homes are built to be thermally safe to live and work in over the lifetime of the building.

**Objectives**

- (a) To encourage passive design to be integrated into every development from the design stage.
- (b) To encourage passive design through site layout, design and construction to reduce the need for active heating and cooling systems and electric lighting.
- (c) To ensure that local housing responds to regional climate conditions and remains thermally safe for occupants for the lifetime of the building:
  - a. as the climate warms
  - b. during the event of a power failure
- (d) To reduce the energy used in buildings.
- (e) To reduce peak electricity demand of developments.

**Controls**

- (a) Development is to be designed and constructed to incorporate passive design measures through site design and analysis. Refer to the Design Guidance for methods to achieve this.
- (b) Development must reduce solar heat gain with the following measures:
  - (i) Glazing on buildings must be high-performance low solar gain low-emissivity glass (single or double glazed units).
  - (ii) Skylights must be high-performance low-emissivity glass or double-glazed glass and should be ventilated.
- (c) Development must enable natural ventilation:
  - (i) Windows must be openable excluding windows that are for light ingress or privacy purposes.
  - (ii) Ceiling or wall mounted fans should be in all habitable rooms (main living areas and bedrooms). This should be notated on DA and CC plans.
- (d) Finishes must provide solar absorptance to mitigate the buildup of urban heat:
  - (i) Wall and roof finishes are to have a solar absorptance of < 0.475
  - (ii) Terracotta roofs are to have a solar absorptance of < 0.70
- (e) Development is to incorporate landscaping that provides canopy and vegetation for cooling to provide resilience during hot and dry periods.

### Design Guidance

- (f) Development is to consider:
  - (i) Physical characteristics of the site;
  - (ii) Site context, such as adjacent buildings or structures affecting the site, relationship of the site to the street, identification of key features such as views and orientation;
  - (iii) Overshadowing caused by existing buildings;
  - (iv) The orientation of true solar north, and a range of 30 degrees east and 20 degrees west of true north;
  - (v) Trees on, or affecting the site, identifying location, type, size and condition; and
  - (vi) Prevailing seasonal winds, sun and shade characteristics.
  
- (g) Development is to be orientated to achieve optimum solar access to thermal mass in winter, and shade thermal mass in summer. To achieve this:
  - (i) Shade north and west facing windows from direct summer sun with external horizontal shading devices such as awnings, upper floor balconies, eaves and overhangs; and
  - (ii) Utilise vertical shading devices such as vertical louvres or fins on east and west facing windows that consider the oblique angles of the sun.
  - (iii) The use of trees and shrubs as an additional method of shading a surface or window is encouraged.
  
- (h) Development must not unduly impact upon the ability of surrounding properties to achieve passive design strategies and solar access.
  
- (i) Insulation is to be used in external walls and roofs to reduce heat escaping from a building in winter and to maintain a lower internal temperature in summer. Position internal walls and partitions to allow for any prevailing passage of air through the building.
  
- (j) Development is to utilize operable natural ventilation to evacuate heat from roof or underfloor cavities in summer, and to retain warmth in winter. Design for cross - ventilation or stack-ventilation where possible to minimise the use of mechanical ventilation.
  
- (k) The use of green roofs or walls to reduce heat absorption and provide thermal mass to a development is strongly encouraged. Refer to *Part B3 Landscaping, Biodiversity and Vegetation Preservation* for additional information.
  
- (l) The use of trees and vegetation as an additional method of shading a roof, window or surface is strongly encouraged.

**2.2 WATER CONSERVATION**

Council is strongly committed to conserving water and improving water quality, in order to enhance water security under climate change, protect our waterways and support cooling and greening in Waverley.

Residential developments should implement measures to actively reduce potable water consumption. Residential water conservation measures are required under the State Environmental Planning Policy (Building Sustainable Index: BASIX) 2004.

**Objectives**

- (a) To encourage sustainable water use practices.
- (b) To reduce the use of potable water.
- (c) To encourage on-site water detention to prevent wastewater and runoff from entering waterways.

**Controls**

- (a) Rainwater tanks connected to outdoor use and toilets and laundry are strongly encouraged for all residential developments.
- (b) Rain tanks must be fitted with a first-flush device that causes initial run-off rainwater to bypass the tank, and
- (c) Rain tanks must be fitted with a screened rain head designed to prevent leaf litter entering into the water tank, and
- (d) Leaf-shedding grills fitted over gutters and downpipes to increase efficiency of rainwater collection are encouraged, and
- (e) All rainwater tanks plumbed for internal water use must have a filter installed to prevent sediment from entering toilets and washing machines, and
- (f) Pumps attached to the development must be housed in an enclosure that is soundproofed, and
- (g) Rain tanks must have its overflow connected to an existing stormwater drainage system that does not discharge to an adjoining property, or cause a nuisance to adjoining owners
- (h) Rain tanks must have a sign affixed to it stating the water in it is rainwater

**Design Guidance**

For more information about rainwater tanks and water conservation refer to:

<https://www.basix.nsw.gov.au/iframe/>  
<http://www.yourhome.gov.au/water/rainwater>  
<http://yourenergysavings.gov.au/water>



## 2.3 INDOOR AIR QUALITY

National Environment Protection Measures exist to achieve ambient air quality that allows for the adequate protection of human health and well-being. Solid fuel burning is associated with adverse health effects, including respiratory effects in adults.

A systematic review on solid fuel combustion exposure and respiratory health in adults in Europe, USA, Canada, Australia and New Zealand found that reducing solid fuel burning improves air quality and improves respiratory health (Guercio et. al., 2022). Similarly, the combustion of natural gas in homes for cooking and space heating purposes is linked to 12% of asthma related cases in Australia (Knibbs et al., 2018). This is a result of chemicals such as nitrogen oxides, carbon monoxide, and sulfur dioxide, as well as particulate matter (PM<sub>2.5</sub>) and formaldehyde, all of which cause inflammation in airways which can result in asthma symptoms (Musgrave, 2020). Electrifying our homes will reduce these pollutants, improving our indoor and outdoor air quality, with significant health benefits for homes and workplaces.

This DCP chapter looks to promote human health through a reduction in polluting fuels and increased ventilation requirements.

### Objectives

- (a) To ensure that ambient air quality levels as specified in the National Environment Protection Measure (Ambient Air Quality) are met for:
  - Carbon monoxide
  - Nitrogen dioxide
  - Ozone
  - Sulfur dioxide
  - Particulate matter (PM<sub>10</sub> and PM<sub>2.5</sub>)
- (b) To improve Indoor Air Quality (IAQ) levels in the built environment, specifically for:
  - Nitrogen oxides
  - PM
  - Volatile Organic Compounds (VOCs)
  - Poly Vinyl Chloride (PVC) and
  - Mould

### Controls

- (a) All residential development must enable ventilation:
  - (i) Windows must be openable excluding windows that are for light ingress or privacy purposes.
  - (ii) Carpark ventilation required under Building Code of Australia clause F4.11 must also integrate CO monitoring and Variable Speed Drive motors.
- (b) Solid fuel heating and cooking systems are not permitted in any development.
- (c) Gas cooktops, gas ovens or gas internal space heating systems are not permitted in any residential development. Instead, electric systems should be installed and clearly marked on DA plans.

## 2.4 RENEWABLE ENERGY AND ENERGY EFFICIENCY

Waverley Council has set an ambitious target to reduce community greenhouse emissions to net zero by 2035. In order to meet this reduction target, all new homes are required to have future capacity to be an all-electric building, powered only by renewable energy.

To achieve net zero by 2035, installing natural gas appliances in new developments is not recommended.

Fluorescent and compact fluorescent lamps contain small amounts of mercury, a highly toxic agent which bioaccumulates in the environment. Recycling rates of fluorescent lamps are as low as 2% (Environment Victoria, 2022). For this reason, Waverley Council supports energy efficient alternatives to fluorescent lamps, such as Light Emitting Diodes (LEDs).

Energy efficiency measures for new residential developments are stipulated under the State Environmental Planning Policy (Building Sustainable Index: BASIX) 2004. Commercial energy efficiency measures are stipulated under the National Construction Code Section J.

### Objectives

- (a) To enable all development to contribute to net zero greenhouse emissions by 2035.
- (b) To reduce the energy demand of all developments.
- (c) To ensure a building can be 100% powered by renewable energy.
- (d) To encourage the installation and use of renewable energy technologies to reduce greenhouse emissions and peak demand.
- (e) To ensure development takes into consideration neighbouring solar technologies in the design of the building.

### Controls

#### Solar photovoltaic system and battery

- (a) The installation of photovoltaic panels with battery storage is strongly encouraged in all developments.

#### Domestic hot water

- (b) An electric hot water system is strongly encouraged in all developments. Recommended systems include:
  - Electric heat pump (most efficient)
  - Solar thermal with electric boost (most efficient)
  - Electric storage

Where a gas hot water system is proposed, specific inclusions shall be provided so that an electric hot water system can be easily retrofitted in the future. See **Design Guidelines** below for recommended requirements for different building types.

### Swimming pool heating

- (c) Recommended swimming pool heating systems include:
- Solar thermal only
  - Solar thermal boosted with electric heat pump
  - Electric heat pump

### Gas cooking and space heating

- (d) Gas cooktops, gas ovens and gas space heating systems are not permitted in residential development as outlined in WDCP *Part 2.3 Indoor Air Quality*.

### Solar access

- (e) Shading from nearby buildings and canopy trees should maintain solar access to existing photovoltaic solar panels and solar hot water heaters.

### Lighting

- (f) Recommended lighting systems include LEDs with controls, such as motion sensors, step-dim controls and daylight sensors.

For more information about renewable energy and energy efficiency refer to:

<http://www.yourhome.gov.au/energy>

<http://yourenergysavings.gov.au/energy>

[http://www.waverley.nsw.gov.au/environment/energy\\_and\\_climate\\_change](http://www.waverley.nsw.gov.au/environment/energy_and_climate_change)

## **Design Guidelines**

### Class 1 building (Single dwellings) – inclusions for future electric system

If a gas instantaneous or gas storage domestic hot water system is proposed then the following inclusions shall also be provided, so that an electric hot water system can be easily retrofitted in the future:

- i) A suitable location to place the future electric hot water system, assuming the relevant setback requirements in Section C2 Low Density Residential 2.2.2 are adhered to.
- ii) An additional electrical circuit and breaker for an electric hot water system rated at a minimum of 20 Amps shall be installed at the switchboard.
- iii) Appropriate electrical cabling in situ from the existing electrical switchboard to the future electric hot water system.

### Class 2 building (Multi-unit development) – inclusions for future electric system

If multiple gas instantaneous hot water systems or a centralised gas storage hot water system is proposed then the following inclusions shall also be provided, so that an electric hot water system can be easily retrofitted in the future:

## Ecologically Sustainable Development **B2**

- i) A suitable location and sufficient space for the future electric hot water system(s) to meet the hot water demand of the residents. This must meet all current Australian Standards for electrical and plumbing installation.
- ii) The existing capacity of the electrical switchboard can meet the electrical demand of the future hot water systems.
- iii) Appropriate electrical cabling is in situ from the existing electrical switchboard to the future electric hot water systems.

## 2.5 ENERGY ASSESSMENT

Applications which have satisfied section 2.5 *Green Star* are deemed to have fulfilled criteria under 2.5 *Energy Assessment*. An *Energy Assessment Report* is a report that demonstrates that the proposed development's predicted greenhouse gas emissions are 30 percent less than those of a reference building. A reference building is a hypothetical building of the same size, shape, floor area and glazing areas as the proposed development, but whose building fabric and building services characteristics are based on the current National Construction Code Section J deemed to satisfy provisions. Any consent will include a condition to require an Energy Assessment Report prior to the issue of any Construction Certificate.

An *Energy Assessment Report* is not required for residential-only development.

### Controls

- (a) A commitment to the provision of an *Energy Assessment Report* must accompany a development application for new mixed use and commercial development with a cost of works of \$3 million or greater. An *Energy Assessment Report* is not required for residential-only development. The commitment is to demonstrate:
  - (i) A proposal which outlines actions that the building will take to achieve greenhouse gas emissions that are 30% less than those of a reference building; and
  - (ii) That an adequately qualified professional has been engaged at the inception of the project to ensure that integrative sustainability measures have been implemented, and that the professional has been contracted to oversee the delivery of the building to these standards.
- (b) An *Energy Assessment Report* is to be submitted prior to the issue of a construction certificate for the development.
- (c) The *Energy Assessment Report* is to include a completed Green Building Council of Australia's Green Star Design & As Built Greenhouse Gas Emissions Calculator available at <http://new.gbca.org.au/green-star/rating-system/design-and-built/> or equivalent modelling tool.
 

This includes:

  - (i) Modelling of the predicted operational energy demand and greenhouse gas emissions of the proposed development.
  - (ii) Proposed solutions to reduce the predicted operational energy use and greenhouse gas emissions of the site and calculations to show the energy use and greenhouse gas emission reductions attributable to each proposed solution.
  - (iii) Potential solutions include:
    - Full electrification of building.
    - Design of site, buildings and services.
    - Commitment to purchase 100% renewable energy.
    - Use of on-site energy efficient technologies.
    - Use of on-site renewable energy technologies where feasible.

**2.6 NABERS COMMITMENT AGREEMENT**

**Background**

NABERS (the National Australian Built Environment Rating System) is a national rating tool which measures the environmental performance of a building, in particular energy and water consumption and waste impact.

A Commitment Agreement is a contract signed by a developer or owner to commit to design, build and commission a building to achieve a specific NABERS energy rating.

**Objectives**

- To ensure all development will reduce water consumption and can reduce greenhouse gas emissions to net zero
- To encourage the use of rating tools to ensure that the environmental performance of the building is verified at occupancy stage and ensure ongoing improvement over time.

**Affects:**

- i. office buildings > 1000m2 net lettable area
- ii. retail premises > 5000m2 gross lettable area
- iii. hotels > 100 rooms
- iv. residential aged care
- v. retirement living
- vi. one of the above plus mixed use

**Control**

- a) Affected buildings are to sign NABERS Commitment Energy and Water Agreements according to the schedule outlined in Table 1.

**Table 1: Minimum NABERS Commitment Agreement requirements**

<b>Building type</b>	<b>Required Commitment Agreement</b>
Office buildings > 1000 m2 net lettable area	5.5 Star Energy 4 Star Water
Retail premises > 5000m2 gross lettable area	5.5 Star Energy 4 Star Water
Hotels > 100 rooms	5.5 Star Energy 4 Star Water
Residential Aged Care <sup>1</sup>	5 Star Energy 4 Star Water

<sup>1</sup> Residential Aged Care is a form of seniors housing that falls under the Housing SEPP 2021. It includes residential care facilities in which residents receive full time care, otherwise known as nursing homes or aged care homes.

Retirement living <sup>2</sup>	5 Star Energy 4 Star Water
One of the above plus mixed use	As listed above

---

<sup>2</sup> Retirement living is a form of seniors housing that falls under the Housing SEPP 2021. It is independent living and consists of apartments or villas for seniors and people living with a disability.



**B3 LANDSCAPING, BIODIVERSITY AND VEGETATION PRESERVATION**

Trees and vegetation are an integral component of the urban environment. They provide habitat for animals, create a distinctive character for an area, visually soften the built environment and improve the natural environment through improved water infiltration, soil stability and air quality.

This part has been developed in accordance with *State Environmental Planning Policy (Biodiversity and Conservation) 2021 (B&C SEPP)* which outlines additional provisions relating to the protection and preservation of trees and vegetation. The terms ‘**vegetation**’ and ‘**clear**’ have specific meanings under the B&C SEPP. This Part adopts the definitions as outlined in the B&C SEPP.

Clearing that is ancillary to development requiring consent will be assessed as part of the development assessment process and may require further assessment and approval under the *Biodiversity Conservation Act 2016*.

This Part of the DCP regulates the clearing of vegetation that is below the Biodiversity Offset Scheme threshold referred to in the *Biodiversity Conservation Act 2016*, and specifies the species, kinds and size of trees protected from damage or removal in the Waverley local government area and for which Council may issue a Vegetation Clearing Permit.

Pruning of all trees to be carried out to Australia Standards AS 4373 – 2007 Pruning of Amenity Trees. Refer to ‘Prune’ in Definitions & Abbreviations section. Pruning in accordance with this Australian Standard prevails over any Council requirement. For the purposes of Part 2.3 of the B&C SEPP, the following vegetation is declared to be vegetation to which the B&C SEPP applies:

- (i) Any vegetation on Land identified as ‘Biodiversity’ on the Terrestrial Biodiversity Map in WLEP; or
- (ii) Any vegetation on Land identified as ‘Biodiversity Habitat Corridor’ in WDCP2022; or
- (iii) A tree identified on the Waverley Significant Tree Register; or
- (iv) A tree or vegetation that forms part of a Heritage Item or is within a Heritage Conservation Area;
- (v) Any tree that has a height of three metres or more; or
- (vi) Any tree that has a canopy spread of three metres or more.

In addition to this Part of the DCP, the *Waverley Tree Management Policy (WTMP)* and *Waverley Tree Management Guidelines (WTMG)* also outlines requirements for all tree and vegetation related activity. Please refer to the WTMP and WTMG for additional information relating to the protection of trees.

**3.1 GENERAL PROVISIONS**

**Objectives**

- (a) To ensure the conservation of trees of ecological, environmental, heritage and aesthetic significance.

- (b) To ensure development does not impact on the health of a tree on the site or adjoining properties or street trees.
- (c) To ensure all works to trees are conducted in accordance with the relevant Australian Standards.
- (d) To increase the level of canopy cover by minimising the loss of vegetation and trees.

**3.1.1 Exempt Vegetation**

The following species of trees are declared weeds under the Biosecurity Act 2015 as prescribed for the Waverley LGA and can be removed without a permit or development consent. However, Council must be notified a minimum of seven days prior to removing any such trees.

Botanic Name	Common Name
<i>Ailanthus altissima</i>	Tree of Heaven,
<i>Celtis sinensis</i>	Hackberry
<i>Citrus spp</i>	Citrus
<i>Ligustrum sinense</i>	Narrow leaved Privet
<i>Ligustrum lucidum</i>	Broad leaved Privet
<i>Nerium oleander</i>	Oleander
<i>Olea europea var. africana</i>	Wild or African Olive
<i>Salix spp</i>	Willows
<i>Schefflera actinophyll</i>	Umbrella Tree
<i>Strelitzia nicolai</i>	Giant Bird of Paradise
<i>Syagrus romanzoffianum</i>	Cocos Palm
<i>Toxicodendron spp</i>	Rhus Tree

Despite any other provisions in this DCP, clearing of vegetation is exempt from the requirement to obtain a Vegetation Clearing Permit in the following circumstances:

- (i) Pruning of a hedge (hedge being defined as a group of two or more trees whether planted in the ground or otherwise, so as to form a hedge and rise to a height of at least 2.5 metres above existing ground level) by no more than 20 per cent of its height and width in any 12-month period;
- (ii) Pruning of a tree with a maximum height of below 5m.
- (iii) Removal of dead branches, palm fronds or palm fruit;
- (iv) Pruning of branches from electricity wires as required by the *Electricity Supply Act 1995*;
- (v) If Council is satisfied that there is a risk to human life or property, e.g. in response to severe storm damage or sudden branch failure. Evidence of the tree’s condition (e.g. arborist or SES report) must be produced at Council’s request. Replacement native trees must be planted if tree/s are removed;
- (vi) Works carried out by state or federal government departments or authorities under current legislative requirement; or
- (vii) If Council is satisfied that the vegetation is dying or dead and is not required as the habitat of native animals.

### 3.1.2 Vegetation Clearing Requiring a Permit

A **Vegetation Clearing Permit** is required to clear:

- (i) Native vegetation on land identified as 'Biodiversity' on the Terrestrial Biodiversity Map in WLEP; or
- (ii) Vegetation larger than 500m<sup>2</sup> on land identified as 'Biodiversity Habitat Corridor' in WDCP; or
- (iii) Any tree that has a height of three (3) metres or more; or
- (iv) Any tree that has a canopy spread of three (3) metres or more.

Note: **Development consent** (via a Development Application) is required for clearing:

- (i) Done in conjunction with development that requires consent under Part 4 of the EP&A Act;
- (ii) Of a tree listed on the Waverley Significant Tree Register;
- (iii) Of any vegetation that forms part of a Heritage Item or is within a Heritage Conservation area (refer to Clause 5.10(2) of WLEP);
- (iv) Of vegetation that is an Aboriginal object or that is located in an Aboriginal place of heritage significance.

Where a development has any potential impact on existing trees an arborist report must be submitted.

#### Tree Assessment

When an application for consent, or a Vegetation Clearing Permit is made, one of Council's qualified arborists will inspect any tree/s to be cleared and undertake a Visual Tree Assessment (VTA). This is a widely accepted arboricultural assessment based on the current health, structural integrity, useful life expectancy and visible damage of the tree. Additional criteria are also taken into consideration including:

- Landscape significance including consideration of the ecological, cultural and amenity value of trees;
- the effect on the health of the tree from pruning;
- whether the tree shows poor form and shape/vigour typical of the species;
- its location within 3 metres of a residence, main building or other significant structure;
- the occurrence (or lack of) other vegetation nearby and whether appropriate replacement species can be planted;
- whether the tree is the identified cause of structural damage to a building, ancillary structure, water main or sewer and if all alternative options of remedying the damage have been considered.

After assessment, the application will either be:

- a. approved; or approved with conditions
- b. pending; awaiting further information or supporting evidence from the applicant
- c. refused; or refused with conditions.

Any application for a Vegetation Clearing Permit should be accompanied with supporting information/evidence such as documented and photographic history of branch failures, the weather conditions at the time of the branch failure; sewer blockages etc.

Presenting this evidence with the initial application can be helpful as it will provide a more complete history of the tree. If no evidence is presented it may result in the refusal of the application.

### **Tree Replacement**

To maintain urban tree canopy cover, when a Vegetation Clearing Permit is granted to clear vegetation, the applicant may be required to replace the vegetation with an advanced approved species which is to be established on their property and maintained to maturity. Where there is insufficient space for replanting advanced vegetation the applicant may provide offset planting on public land. This may be undertaken by entering into a deed of agreement with Council. Generally, for every tree removed, the replacement of three (3) off-site trees will be required with pot size dependent on the canopy spread of the tree(s) to be removed as assessed by Council. Audit checks of replacement planting will be carried out by Council. Refer to Part 3.2.4.

### **Arborist and Other Specialist Reports**

Supporting evidence for the removal or pruning of a tree/s may require a report from a consulting arborist (AQF Level 5) where there is insufficient evidence to support the removal of a tree as assessed against the above criteria. Council may request the applicant to provide an arborist's report for more complex tree assessments such as an aerial inspection; root mapping or identification; fungal or pest problems; or internal diagnostic assessment.

Further supporting evidence may also be required from a structural engineer or licensed plumber if buildings or underground services are affected. Details of requirements for arborist and other specialist reports are listed in the appendices of the WTMG.

#### **3.1.3 Trees considered to pose an imminent danger**

- (a) Except for specified emergency situations, expert advice should always be obtained with respect to hazardous trees to confirm their condition.
- (b) Where a hazardous tree is removed (in an emergency situation) due to obvious instability or hazard (e.g. following a storm), Council's Tree Management must be notified prior to removal. It is recommended that evidence of the tree's condition be retained for a period of at least six (6) months after the event and produced at Council's request if needed. Such evidence might include a:
  - (i) Report by a consulting arborist including photographs; and/or
  - (ii) Written statement from the State Emergency Services, if the Service carried out the emergency work at the owner's request.
- (c) If trees are removed for the above reasons it is a requirement to plant replacement trees of a suitable native species to maintain canopy cover in Waverley. Refer to Part 3.1.4.

## **3.2 LANDSCAPING**

### **Objectives**

- (a) To enhance the amenity and visual setting of the site, streetscape, and surrounding neighbourhood.

- (b) To ensure development contributes to the urban canopy.
- (c) To retain and increase remnant populations of endemic flora and fauna.
- (d) To maximise on site stormwater infiltration and minimise off site stormwater runoff.
- (e) To minimise the adverse impacts of light pollution on local fauna.

### 3.2.1 General Controls

- (a) A Landscape Plan is required to be submitted in accordance with the *Waverley Development Application Guide* and include:
  - (i) A schedule of the common name and scientific name of species to be planted, the size and number; and
  - (ii) A plan showing the location of the plants in the schedule.
- (b) Existing significant vegetation is to be retained and enhanced.
- (c) The landscaping should maintain and increase vegetation and urban tree canopy in Waverley.
- (d) Species should be retained, selected and placed in order to help achieve the following:
  - (i) Cool buildings in summer;
  - (ii) Intercept glare from hard surfaces;
  - (iii) Channel cooling air currents into the dwelling in summer;
  - (iv) Allow sun into living rooms in cooler months; and
  - (v) Provide windbreaks where desirable.
- (e) Existing natural features including sandstone and rock features are to be retained and incorporated as landscape features on the site in order to maintain the natural character of the landscape. Sandstone walls and finishes fronting the public domain are to match the traditional pattern and colour of sandstone in the area.
- (f) Landscaping is to be designed to minimise non-porous areas and maximise on-site infiltration of stormwater. Paved areas are to be semi-porous or graded to maximise on-site infiltration.
- (g) Landscaping must relate to the building scale and assist integration of the development with the existing street character.
- (h) Landscaping should include native plant species and select and position trees to maximise control of sun and winds.
- (i) All development proposals are to be designed to eliminate the impact upon significant trees on site, street trees and trees on adjoining land including public open space and bushland.
- (j) External illumination fixtures must be directed downwards and away from reflective surfaces, avoid spill into parks, reserves and bushland and avoid short wavelength (blue-violet) light.
- (k) Utilise lightweight soil mixes that are porous, able to drain freely, and suitable for the selected plant species. Seek suitable professional advice regarding appropriate soil depths and types. As a guide, Table 1 provides minimum soil requirements.

Plant Size	Minimum Soil Requirements	
Large Trees (>8m height)	Volume	100 cubic metres
	Depth	800mm
Medium Trees (3 – 8m height)	Volume	60 cubic metres
	Depth	800mm
Small Trees (up to 3m height)	Volume	20 cubic metres
	Depth	800mm
Shrubs (up to 3m height)	Depth	600mm
Ground cover and turf	Depth	300mm

**Table 1** Minimum soil requirements

### 3.2.2 Landscape on Structures

#### Objectives

- (a) To encourage engaging communal open spaces to be created above basement or podiums, or on roof tops.
- (b) To ensure that adequate provision is made for soil depths, structural provisions to support planting, and drainage and waterproofing requirements.

#### Controls

- (i) Where set downs are provided, ensure the depth is suitable for paving thickness or the required soil depth for the proposed plants.
- (ii) Minimise visual and physical clutter through the careful design of planter beds and mounds.
- (iii) Innovative design strategies that allow integrated seating to be provided through planter beds at 450mm high are encouraged.
- (iv) Provide raised platforms or mounding to achieve greater soil depth to support planting of larger trees in appropriate areas.
- (v) Demonstrate that adequate drainage and waterproofing is provided for the species and volumes of plants and soil.
- (vi) Provide appropriate methods for capturing, storing and treating run off from landscapes on structures for reuse on the site.
- (vii) Utilise lightweight soil mixes that are porous, able to drain freely, and suitable for the selected plant species.

### 3.2.3 Green Roofs and Walls

#### Objectives

- (a) To encourage the use and installation of green roofs and walls to increase building performance, thermal comfort, fauna habitat, localised air temperature and aesthetics of the urban environment.
- (b) To encourage green roofs and walls in commercial and mixed use zones.
- (c) To encourage green roofs and walls to be integrated into existing and new developments.
- (d) To ensure green roofs are non-trafficable areas which do not cause adverse visual or acoustic privacy impacts on neighbouring properties.

#### Controls

- (a) Council will determine if a green roof will be considered as landscaped area on a site-by-site basis.
- (b) Green roofs are not to be used as recreational areas.
- (c) The selection of plant species must give consideration to sun access, wind, views, overshadowing and other environmental conditions.
- (d) Utilise lightweight soil mixes that are porous, able to drain freely, and suitable for the selected plant species. Seek suitable professional advice regarding appropriate soil depths and types.
- (e) Visual impact:
  - (i) Where a green roof or wall affects views, careful consideration is to be taken to ensure the chosen species of plants will not interrupt or diminish views from adjacent properties.
  - (ii) Green roofs must be contained within the overall building height limit.
  - (iii) Green roofs or walls are not to detract from the heritage significance of a building or heritage conservation area.
- (f) Any access is to be for servicing the green roof only.
- (g) To discourage recreational use of the roof, a balustrade at the perimeter is not permitted.
- (h) The green roof is to have a minimum soil depth of 300mm for ground covers.
- (i) Demonstrate that adequate drainage and waterproofing is provided for the species and volumes of plants and soil.
- (j) Provide appropriate methods for capturing, storing and treating run off from landscapes on structures for reuse on the site.
- (k) Consideration should be given to the strength of a waterproofing membrane through the following method:
  - (i) Flood testing
  - (ii) Electrical field vector mapping (EFVM)
  - (iii) Destructive testing.
- (l) The overall design of the green roof should minimise wind uplift.
- (m) Sub-surface drip irrigators should be used to direct moisture to plant roots.
- (n) Irrigation should be provided from rainwater harvesting, treated grey water or treated black water.



### 3.2.4 Tree Canopy

#### Objectives

- (a) To protect and increase tree canopy of the LGA.
- (b) To preserve and enhance landscape character.
- (c) To maintain habitat for native fauna.
- (d) To capture the cooling benefits of canopy.
- (e) To support the *Waverley Community Strategic Plan 2022-2032* minimum 29% LGA canopy and shrub cover target.

#### Controls

- (a) Development must not result in the loss of tree canopy.
- (b) For Development Applications that involve external works, a Landscape Plan must be submitted showing the locations of tree species, other proposed plants species, any existing trees and vegetation to be maintained and the area of the canopy of the Landscape Plan when planting is mature.
- (c) Where a tree that is **3m or more in height or has 3m or more canopy spread** is proposed for removal under a Development Application, replacement planting of suitable species should be planted on the site that maintain or increase the tree canopy on the site when mature.
- (d) Replacement plantings on site must be of the same or greater canopy size when mature than the canopy proposed to be removed as confirmed by a Landscape Plan and Arborist. Replacement trees planted in accordance with control (c) are to be selected from the list of plantings in Annexure B3-2, and **minimum 45L pot sizes**.
- (e) If there is insufficient planting space on site to accommodate a tree of similar dimensions when mature, the applicant will be asked to contribute to offset planting on public land. Generally, for every tree removed, the replacement of a minimum of three (3) off-site trees will be required in accordance with Council's policy.

### 3.3 BIODIVERSITY

This Part aims to retain, protect and promote the recovery of remnant native vegetation and native flora and fauna, threatened species, populations, ecological communities and their habitats. The requirements for biodiversity provided for by this Part are to be considered in parallel with the Biodiversity Conservation Act 2016.

Since European Settlement, Waverley has lost over 99% of its original vegetation. Waverley contains 5.9 hectares of remnant bushland, occurring as scattered pockets on cliff edges, in parklands, road reserves and within private property, providing habitat and food for native wildlife. Due to their local significance, these remnants must be protected. These areas also contain the threatened plant species, Sunshine Wattle, which are both protected by state and Commonwealth legislation.

Areas of introduced native and non-native vegetation have also been recognised as providing important habitat for native wildlife. Identified biodiversity habitat corridors link areas of remnant vegetation with each other and with recognised non-remnant habitat areas.

Council acknowledges the intrinsic value of remnant vegetation or bushland, as well as the habitat and other environmental values of revegetated areas and the need to protect them from the degrading influences of surrounding development and other urban pressures.

#### 3.3.1 Terrestrial Biodiversity

The following objectives and controls relate to land identified in the **Terrestrial Biodiversity Maps** located within WLEP as remnant vegetation, or land adjoining remnant vegetation. Definitions are included at the end of this DCP.

Waverley's remnant vegetation includes patches of the Critically Endangered Ecological Community Eastern Suburbs Banksia Scrub (ESBS), and the Endangered plant species Sunshine Wattle, *Acacia terminalis subsp. Eastern Sydney*. Both are protected by the *Commonwealth Environment Protection and Biodiversity Conservation Act 1999*, and in the *NSW Biodiversity Conservation Act 2016*.

##### Objectives

1. To retain, protect and enhance remnant native vegetation for local wildlife and benefits to the community.
- (b) To protect and promote the recovery of threatened species, populations, and endangered ecological communities.
- (c) To reduce the adverse impacts of light pollution on local fauna.

##### Controls

- (a) A minimum of 90% of the proposed trees, 90% of the proposed shrubs and 90% of the proposed grasses and groundcovers (not including turfed areas) are to be native plants that are listed in *Annexure B3-1*. Cultivars or hybrids of listed plant

species are not to be counted towards this requirement. Landscape plans must include a planting schedule that lists all plant species proposed, the number of plants of each species proposed, and indicate whether each plant species proposed is listed in *Annexure B3-1*.

- (b) Three strata of vegetation are required to be included in landscape design, e.g. (i) tree or tall shrub canopy, (ii) mid-storey and (ii) groundcover layer.
- (c) All plants identified as priority weeds under the Biosecurity Act 2015, and those plants identified by Council as local environmental weeds on the property at the time of development are to be removed by a suitably qualified person.
- (d) Trees with hollows are to be retained for habitat wherever possible to provide habitat for arboreal fauna. Consideration must be given to the potential risk of damage to public or private property as determined by a suitably qualified arborist.
- (e) Sites that are undeveloped should be protected to encourage regeneration from the seed bank. *Sunshine Wattle* has a persistent soil seed bank which may last for up to 50 years (DECCW, 2007:8).
- (f) Council may require additional supporting information for an application including the following:
  - (ii) Vegetation management/protection plan; and
  - (iii) Flora or fauna impact assessment; and/or
  - (iv) An indication as to whether the proposed development is likely to significantly affect threatened species, populations, ecological communities or their habitat assessed in accordance with the *Biodiversity Conservation Act 2016*.
- (g) External illumination fixtures on land adjoining remnant vegetation must be directed downwards and away from reflective surfaces, avoid spill into parks, reserves and bushland and avoid shorter wavelength (blue-violet) light.
- (h) Remnant vegetation is to be protected. However, the removal of remnant vegetation may be authorized under other legislation including:
  - (i) Trees and vegetation are removed/trimmed in accordance with the *Roads Act 1993*;
  - (ii) The work needs to be carried out by Council, the State Emergency Services, the Rural Fire Service of NSW, or a public authority in response to an emergency;
  - (iii) Works are carried out by State or Federal Government Departments or Authorities under current legislative requirements; or
  - (iv) The tree or vegetation is a recognised noxious weed (*Biosecurity Act 2015*). The applicant must first seek advice from Council and Council must be notified in writing seven (7) days prior to the commencement of removal work.

---

### **3.3.2 Habitat Corridors and Recognised Habitat**

Wildlife movement allows migration, dispersal, interbreeding and recolonisation of fauna species to occur, improving long-term viability of the species and local populations. Wildlife movement also facilitates plant pollen and seed dispersal, thus enhancing the viability of plant populations. Continuous Habitat Corridors are often preferable, but discontinuous 'stepping stone' corridors still contribute significantly to fauna movement and can be improved through habitat enhancement and plantings of local native species.

This part refers to land identified in the ‘**Biodiversity Habitat Corridor**’ Layer in the DCP, accessible on Council’s mapping website.

Waverley Online Mapping Tool	
<a href="https://planning.waverley.nsw.gov.au/connect/analyst">https://planning.waverley.nsw.gov.au/connect/analyst</a>	
Map Configuration	Planning
Layer	Biodiversity Habitat Corridor

Definitions are included at the end of this DCP.

### Objectives

- (a) To ensure development contributes to the landscape character of the area.
- (b) To enhance planted native vegetation and the ecological functions of habitat corridors.
- (c) To reconstruct habitat in non-vegetated areas of designated wildlife corridors that will as far as possible, represent the combination of plant species and vegetation structure of the original community.
- (d) To reduce the adverse impacts of light pollution on local fauna.

### Controls

- (a) A minimum of 50% of the proposed trees, 50% of the proposed shrubs and 50% of the proposed grasses and groundcovers (not including turfed areas) are to be native plants that are listed in *Annexure B3-1*. Cultivars or hybrids of listed plant species are not to be counted towards this requirement. Landscape plans must include a planting schedule that lists all plant species proposed, the number of plants of each species proposed, and indicate whether each plant species proposed is listed in *Annexure B3-1*.
- (b) Three strata of vegetation are required to be included in landscape design (i) tree or tall shrub canopy, (ii) mid-storey and (ii) groundcover layer.
- (c) All plants identified as priority weeds under the *Biosecurity Act 2015*, and those plants identified by Council as local environmental weeds on the property at the time of development are to be removed by a suitably qualified person.
- (d) Trees with hollows will be retained for habitat wherever possible to provide habitat for arboreal fauna. Consideration must be given to the potential risk of damage to public or property as determined by a suitably qualified arborist.
- (e) Council may require additional supporting information for an application including the following:
  - (i) Vegetation management/protection plan; and/or
  - (ii) Flora or fauna impact assessment; and/or
  - (iii) An indication as to whether the proposed development is likely to significantly affect threatened species, populations, ecological communities or their habitat assessed in accordance with the *Biodiversity Conservation Act 2016*.
- (f) External illumination fixtures must be directed downwards and away from reflective surfaces, avoid spill into parks, reserves and bushland and avoid short wavelength (blue-violet) light.

### 3.4 PROTECTING TREES ON DEVELOPMENT SITES

Damage to trees on development sites is often caused because of a failure to appreciate their vulnerability, particularly the root system which can decline in health over several seasons following detrimental alterations to the soil environment. It is necessary that development takes into consideration trees both on the site and those on adjoining sites including street trees.

#### Objectives

- (a) To ensure development does not impact on the health of a tree on the site or adjoining properties or street trees in accordance with *Australian Standard – AS 4970 – 2009 - Protection of Trees on Development Sites*.

#### Controls

- (a) When a proposed development may have an impact on trees on the site, on adjoining properties or public trees within 4 metres of the site, the following information is required at these stages:
1. Pre Development Application.
    - Preliminary Tree Assessment.
  2. Lodgement of Development Application.
    - Arboricultural Impact Assessment (include data if previous preliminary tree assessment submitted);
    - Tree Protection Plan – for trees identified as moderate to high retention; and
    - Root mapping report if construction works will occur in structural root zone (SRZ) or there is major encroachment in the tree protection zone (TPZ) of trees to be retained.
  3. Prior to Construction Certificate.
    - Final Tree Protection Plan (if modifications are required);
    - Tree Protection Certification during works.
  - (iv) Prior to Occupation Certificate.
    - Tree Monitoring Report / Final Tree Protection Certification.
- (b) Details of requirements of the above reports are listed in the Waverley Tree Management Guidelines appendices. Development applications must show all associated building works (including stormwater, hydraulic and sewerage works) located within any tree protection zone.
- (c) Selective pruning or removal of trees that conflict with proposed building works may be approved where redesign of the building work is not possible or will result in inferior building performance. However, Council may require the redesign of a development proposal to retain or lessen the impact on a significant or prominent tree.

### 3.5 PENALTIES

Any clearing of vegetation carried out without a Vegetation Clearing Permit, not in accordance with a development consent, or that is not exempt will be dealt with in accordance with the relevant legislation. This may result in a Penalty Infringement Notice or legal action through either the Local Court or the Land and Environment Court against all parties involved in any breach of the WLEP, the B&C SEPP, or any conditions of consent.

Where a person is guilty of an offence involving the destruction of, injure or damage to vegetation, the court dealing with the offence may, in addition to or in substitution for any pecuniary penalty imposed or liable to be imposed, direct that person to:

- (a) Repair or remedially prune damaged trees;
- (b) Plant new trees and vegetation and maintain those trees and vegetation to a mature growth/or minimum height of five (5) metres; and
- (c) Provide security for the performance of any obligation imposed under paragraph (a) & (b) above.

**Note:** *injure a tree means but is not limited to:* poisoning; spilling or washing off toxic chemicals; applying herbicides to a tree or within its Tree Protection Zone; damage to tree roots from stockpiling materials, soil compaction, filling, excavation or altering soil levels within its Tree Protection Zone; wounding to tree trunks or the breaking or tearing of roots or branches; wounding to trunks or branches from fixing objects using nails, wires, staples or similar fastening materials e.g. attaching signs, swings, platforms or cubby houses.

## B4 COASTAL RISK MANAGEMENT

Coastal risks include risks from erosion, inundation and geotechnical instability. Erosion refers to the wearing away of the land by the action of natural forces. Coastal or tidal inundation is the flooding of coastal lands by ocean waters, which is generally caused by large waves and elevated water associated with severe storms and the peak of the high tide. Geotechnical risks in the coastal zone refer to coastal cliff or slope instability.

This part refers to land identified in the 'Geotechnical Risk' or 'Coastal Inundation' Layers on Council's mapping website.

Waverley Online Mapping Tool	
<a href="https://planning.waverley.nsw.gov.au/connect/analyst">https://planning.waverley.nsw.gov.au/connect/analyst</a>	
Map Configuration	Planning
Layer	Geotechnical Hazard
	Coastal Inundation

Any application for new buildings, significant alterations and/or additions to existing buildings and/or new swimming pools on properties identified as affected by 'Coastal Inundation' or 'Geotechnical Risk' are required to submit the following with a development application (refer to the *Waverley Development Application Guide*):

- (a) Coastal Risk Assessment; and/or
- (b) Geotechnical Risk Assessment.

Refer to Council's *Coastal Risk Management Policy 2012* for further information



## B5 WATER MANAGEMENT

This Part contains planning controls relating to the management of all aspects of the water cycle in an integrated and consistent manner. The planning controls promote the need for long-term sustainable social, ecological and economic outcomes.

This Part is to be read in conjunction with Council's *Water Management Technical Manual* (Technical Manual) which provides further details on controls outlined in this Part. For more detailed information on flood related risks, refer to the *Waverley LGA Flood Study 2021*.

This Part applies to all development (excluding minor alterations and additions, retro-fits, and the like).

### 5.1 STORMWATER MANAGEMENT AND WSUD

For information on how to implement WSUD refer to the Sydney Metropolitan Catchment Management Authority website, accessible at the following link: [www.wsud.org](http://www.wsud.org).

#### Objectives

- (a) To promote the implementation of Water Sensitive Urban Design (WSUD).
- (b) To minimise the impacts of development upon the water cycle.
- (c) To encourage sustainable development through the integration of stormwater management systems into the landscape.
- (d) To ensure that development considers flooding, coastal water and groundwater protection, habitat creation and improves visual amenity.
- (e) To integrate water sensitive urban design with landscape and building design.
- (f) To reduce the volume of stormwater run-off.
- (g) To promote increased on-site stormwater retention, detention, and recycling.
- (h) To improve catchment water quality.
- (i) To minimise the impacts of urban development upon water balance and surface and groundwater flow regimes.
- (j) To promote infiltration within the "Infiltration zone" and reduce stormwater run-off (refer to Annexure B in the *Water Management Technical Manual*).
- (k) To encourage the use of soft landscaping and permeable paving as an alternative to impervious surfaces.
- (l) To prevent stormwater from overflowing into basement garages of residences.
- (m) To protect existing natural groundwater flows and downstream properties from seepage.

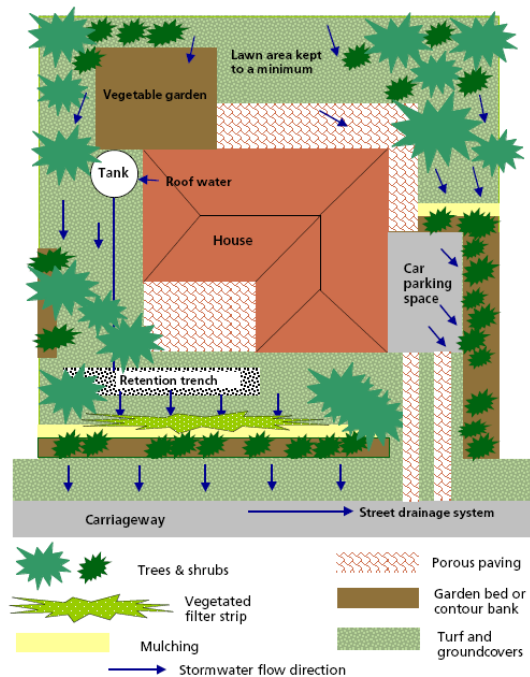
#### Controls

- (a) A stormwater management plan is required to be submitted with all development applications (except minor alterations, retrofits and the like).
- (b) WSUD principles are to be integrated into the development through the design of stormwater drainage, on-site detention and landscaping and in the orientation of the development rather than relying on 'end of pipe' treatment devices prior to discharge (refer to Figure 1).
- (c) WSUD measures are to be employed to prevent contamination of stormwater.
- (d) Development is to be sited and built to minimise disturbance of the natural drainage system.
- (e) WSUD elements should be located and configured to maximise the impervious area that is treated.

- (f) On site detention is to be designed, installed and maintained in accordance with the *Water Management Technical Manual*.
- (g) Council consent is required for temporary/permanent dewatering and groundwater extraction and use prepared in accordance with the *Water Management Technical Manual*. The proposal is assessed on merits and where appropriate, referred by Council to the relevant Government department for an access licence.
- (h) Applications for roof water and stormwater harvesting and reuse and grey water or black water treatment systems will be assessed on merit in accordance with the WM Technical Manual.
- (i) Methods of disposal of stormwater from the site must be provided using one or a combination of the following:
  - (i) Infiltration;
  - (ii) Gravity connection to Council's stormwater system;
  - (iii) Charged system; and / or
  - (iv) Pump system.

**Note:** A stormwater system must be constructed in accordance with *AS/NZS 3500:2003 National Plumbing & Drainage* and *Water Management Technical Manual*.

- (j) Depending on the extent of disturbed area, the following plans to manage erosion and sedimentation must be submitted with the development application:
  - (i) For areas of disturbance less than 250m<sup>2</sup>, a marked up plan of proposed works and control measures is required;
  - (ii) For disturbed areas between 250m<sup>2</sup> and 2,500m<sup>2</sup>, an erosion and sediment control plan is required; and
  - (iii) For disturbed areas greater than 2,500m<sup>2</sup> soil and water management plan is required.



**Figure 1** Example of an integrated stormwater strategy for a dwelling

**5.2 FLOOD PLANNING**

The NSW State Government defines the ‘Floodplain’ as ‘land susceptible to flooding by the PMF (probable maximum flood) event’. The document also defines ‘flood’ as natural phenomena where water inundates land that is usually dry, generally due to weather systems that generate a high amount of rainfall. Flooding can be due to water flowing within, out of, or towards a waterway. Water that runs towards a watercourse is known as an overland flow and this type of flooding is the predominant type of flooding that occurs throughout the Waverley Local Government Area.

For the purposes of insurance most of the water where inundation could occur, aside from Bronte Gully and Tamarama Gully, in the Waverley LGA should be considered as ‘stormwater’.

Sections 5.2.1-5.2.8 apply to land identified in the ‘Flood Planning Area’ layer on Council’s mapping website and in annexure B5-4. These Flood Planning Areas cumulatively represent the Flood Planning Area referred to in clause 5.21 of Waverley LEP 2012.

Waverley Online Mapping Tool	
<a href="#">Discover Waverley Mapping Tool</a>	
Map Configuration	Planning
Layer	Flood Planning Area

Section 5.2.9 provides controls for all other development.

There are three different levels of potential flood risk associated with the Flood Planning Area, high, medium and low, see below.

**Table 1** Flood Risk Precinct Definitions

Flood Risk Precinct	Description	Technical Definition
High	Land within the 1% AEP flood extent with a high hydraulic hazard classification. There is a high potential for damage to property, risk to life or evacuation difficulty.  <i>In this precinct there would be a significant risk of flood damages without compliance with flood related building and planning controls.</i>	Land classified as “H4-H6” in the 1% AEP event.
Medium	Land below the 1% AEP flood that is not subject to high hydraulic hazard and where they are no significant evacuation difficulties.  <i>Note: in this precinct there would still be significant risk of flood damage, but these damages can be minimised by the application of appropriate development controls</i>	Land classified as “H1-H3” in the 1% AEP event.

<p>Low</p>	<p>All other land within the floodplain (i.e.. within the extent of the Probable Maximum Flood (PMF), that is not classified as a High or Medium Flood Risk Precinct.</p> <p><i>Note: The Low Flood Risk Precinct is where the risk of damages is low for most land uses. The Low Flood Risk Category is the area above the 1% AEP flood.</i></p>	<p>Flood affected land between the PMF and 1% AEP extent.</p>
------------	---	---

**Notes:**

1. *Where sufficient information is not available, but the potential for flood risk issues are evident based on available information, applicants may be required to undertake a site specific flood assessment. These situations include where:*
  - a) *Council has knowledge that the property has been previously affected by or impacted upon flooding or an overland flow path;*
  - b) *The property is on the low side of the road and/or the boundary levels are below the level of Council's kerb;*
  - c) *The property is lower than surrounding properties;*
  - d) *The property is in a natural low point, gully or depression; or*
  - e) *The property is adjacent to or contains a flow path, open channel, watercourse or drainage line.*

*The assessment would determine the Flood Risk Categories in order to apply appropriate controls in addition to any further assessments required by this Development Control Plan.*
2. *Technical definitions for Flood Risk Precincts as outlined in Table 1 are defined by the relevant flood events in the governing study, which is the most recently endorsed Council Flood Study or Flood Risk Management Study and Plan.*

### Objectives

- (a) Minimise risk to life and damage to property by controlling development on flood prone land
- (b) Ensure the impacts of the full range of potential floods up to and including the PMF are considered when assessing development having regard to the sensitivity of different land uses to flooding.
- (c) Ensure that development does not have an unacceptable impact on flood behaviour, people's safety, surrounding properties and structures, and the natural environment.
- (d) To provide detailed controls that if satisfied would address the considerations required by clause 5.21 of *Waverley Local Environmental Plan 2012*.

### Controls

#### How to determine what planning controls apply

Refer to land use risk categories the table below in Annexure B5-1, and the planning controls matrix below to determine which controls are applied.

#### Application of Controls

Compliance with the prescriptive controls must be demonstrated.

Where the prescriptive controls are not satisfied, applicants must demonstrate, based on site specific assessments, that the performance criteria are clearly satisfied to the satisfaction of Council.

Planning Controls Matrix for Flood Planning

The Planning Controls Matrix identifies the prescriptive flood related development controls that apply to the Flood Planning Areas and land use category. Refer to Annexure B5-1 for explanations of each land use category.

Table 2 Planning Controls Matrix

Flood Risk	Low Flood Risk								Medium Flood Risk						High Flood Risk									
	Critical uses and facilities	Sensitive Uses and Facilities	Subdivision	Residential	Commercial or Industrial	Tourist Related Development	Recreation or Non-urban Uses	Concessional Development	Critical uses and facilities	Sensitive Uses and Facilities	Subdivision	Residential	Commercial or Industrial	Tourist Related Development	Recreation or Non-urban Uses	Concessional Development	Critical uses and facilities	Sensitive Uses and Facilities	Subdivision	Residential	Commercial or Industrial	Tourist Related Development	Recreation or Non-urban Uses	Concessional Development
Floor Level	3	3		2	2	2					2, 4	2, 4	2, 4	1	5				2, 4	2, 4			1	5
Building Components	2	2		1	1	1					1	1	1	1	1				1	1			1	1
Structural Soundness	2	2				2					1	1	2	1	1				1	1			1	1
Flood Affection										1	1	1	1	1	1				1	1	1		1	1
Car Parking & Driveway Access	2, 3, 4	2, 3, 4	2, 3, 4	2, 3, 4	2, 3, 4	2, 3, 4	2, 3, 4	2, 3, 4			1, 2, 3, 4, 5	1, 2, 3, 4, 5	1, 2, 3, 4, 5	1, 2, 3, 4, 5	4, 5	4, 5			1, 2, 3, 4, 5	1, 2, 3, 4, 5			4, 5	4, 5
Emergency Management	2, 3	2, 3	1	1	1	1	1	1			4	1	1, 3	1, 3	1, 3	1			4	1	1, 3, 5		1, 3	1
Management & Design			1								1	2, 4	2, 3	2, 3, 4	2, 3, 4	2, 4			1	2, 4	2, 3		2, 3, 4	2, 4
Fencing	1	1	1	1	1	1	1	1			1, 1	1, 1	1, 1	1, 1	1, 1				1, 1	1, 1	1, 1		1, 1	1, 1

Key

No controls	
Subject to significant flood constraints (refer to General Note 1)	
DCP Control Reference no.	1

General Notes:

- Significantly Constrained Land:** Where development types are likely to be incompatible with the hazards existing within the nominated part of the floodplain without substantial mitigation measures. Consequently, the development may be found unacceptable unless the design of the development together with the mitigation measures can address any potential unacceptable amenity or environmental impacts. Alternatively, this may require a reduction in the otherwise anticipated development intensity for the land.
- Filling:** Filling of a site, or site modification works in general, that is partially affected by flooding (if acceptable to Council) may change the flood risk precinct, and the associated development controls that apply to development on the site.
- Multiple FRPs:** Development controls relate to the FRP identified for the site. Where a site has two or more FRPs the relevant sets of controls apply to each risk precinct but for practical purposes the stricter controls would normally apply across the whole development.

4. **Fencing:** Refer to the relevant fencing section of the DCP for planning considerations involving only the erection of a fence for the type of development your application is considered. Any fencing that forms part of a proposed development is subject to the relevant flood effect and structural soundness considerations of the relevant category.
5. **Freeboard:** Where required the following freeboard heights apply:
  - a. Areas subject to oceanic flooding conditions: 500mm
  - b. Other areas: 300mm.
6. **Mixed Use Development:** For mixed-used developments, the planning controls apply to each use to the extent relevant. For example, Floor level and Building Component controls will typically apply to only the ground floor, while the balance of the controls could apply to the overall development.
7. **Subdivision:** When assessing subdivision the planning controls for the intended end use will be taken into consideration to ensure that any potential development on a new lot would be capable of meeting the controls.

---

### 6.2.1 Floor Level

#### Performance Criteria

1. The cost of damages that may be incurred over the expected life of a development should be no greater than that which could be reasonably expected to be met by the occupants and/or the developer without Government assistance.
2. Despite the need to elevate floors, the development must remain acceptable with regard to its appearance and accessibility from the public domain and the amenity of the occupants.

#### Prescriptive Controls

1. All floor levels are to be equal to or greater than the 5% AEP flood level.
2. Habitable floor levels are to be equal to or greater than the 1% AEP flood level plus freeboard.
3. All floor levels are to be equal to or greater than the PMF level unless justified by a site-specific assessment.
4. All non-habitable floor levels shall be no lower than the 1% AEP flood level. Where this is impractical, non-habitable spaces should be flood-proofed to the 1% AEP level.
5. Floor levels shall be equal to or greater than the level of the 1% AEP flood level plus freeboard. Where this is not practical due to compatibility with the height of adjacent buildings, or compatibility with the floor level of existing buildings, or the need for access for persons with disabilities, a lower floor level may be considered. In these circumstances, the floor level shall be as high as practical and when undertaking alterations or additions no lower than the existing floor level.



---

### 5f.2.2 Building Components

#### Performance Criteria

1. All structures are to have flood compatible building materials below the prescribed flood planning floor level.

#### Prescriptive Controls

1. All new structures are to have flood compatible building components below or at the 1% AEP flood level plus freeboard. Refer to Annexure B5-3 for a list of recommended flood compatible building components.
2. All new structures to have flood compatible building components below or at the PMF level.

---

### 5.2.3 Structural Soundness

#### Performance Criteria

1. All development would be structurally sound when impacted by a 1% AEP flood plus freeboard.
2. Where development relies on sheltering in place to be acceptable it would be structurally sound when impacted by a PMF.

#### Prescriptive Controls

1. As part of Flood Impact Assessment (FIA), an engineer's report (refer to Annexure B5-3 for details) shall be provided for development to certify that any new structure can withstand the forces of floodwater, debris & buoyancy up to & including a 1% AEP flood level plus freeboard. Note: certification to be up to and including PMF if required to satisfy evacuation criteria (see below).
2. As part of Flood Impact Assessment (FIA), an engineer's report (refer to Annexure B5-3 for details) shall be provided for developments to certify that any new structure can withstand the forces of floodwater, debris & buoyancy up to & including the PMF level.

#### 5.2.4 Flood Affection

##### Performance Criteria

1. Development does not detrimentally increase the potential flood affection on other development or properties either individually or in combination with the cumulative impact of development that is likely to occur in the same floodplain.
2. Development should not change the height or behaviour of flood waters elsewhere in the floodplain in a manner which is likely to materially and adversely impact other property. The assessment of these effects must include the potential for similar impacts that would arise as a consequence of other development in the floodplain that has the potential to occur in the future under current zoning and planning controls.

##### Prescriptive Controls

1. As part of a Flood Impact Assessment (FIA), an engineer's report (refer to Annexure B5-3 for details) shall be provided to certify that the development (including indoor and outdoor features, such as above ground swimming pools and associated pump housing) will not materially increase flood effects elsewhere, having regard to:
  - loss of flood storage;
  - changes in flood levels, flows and velocities caused by alterations to the flood conveyance.

#### 5.2.5 Car Parking and Driveway Access

##### Performance Criteria

1. Measures will be in place to warn people not to drive out of car parking areas where this would be dangerous and provide guidance and facilities to be able to safely exit the carpark.
2. All reasonable and practical measures are implemented to reduce the likelihood of motor vehicles being damaged by a flood.
3. All reasonable and practical measures will be in place to manage the potential vehicles floating and causing damage or becoming debris during a flood.

##### Prescriptive Controls

1. The minimum surface level of open car parking spaces or carports shall be no lower than the 5% AEP flood level plus freeboard.
2. Garages for three (3) or fewer vehicles shall have a minimum finished floor level no lower than the 5% AEP flood level plus freeboard.
3. Basement car parking shall be protected from inundation by a 1% AEP flood plus freeboard.

4. The crest of the driveway providing access between the road and basement car- parking shall be a minimum of 1% AEP flood plus freeboard or the PMF, whichever is higher.
5. Restraints or vehicle barriers may be required to prevent floating vehicles leaving a site during a 1% AEP flood. \* (Note: A flood depth of more than 200mm will cause serious water damage to a typical vehicle and a depth of 300mm is sufficient to cause a typical vehicle to float.)

*\*Note: For control no.5. site by site considerations will be assessed based on context and risk.*

---

### **5.2.6 Emergency Management**

#### **Performance Criteria**

6. The development should be designed and be able to be managed to ensure that during a flood emergency all occupants are capable of seeking safe refuge.

#### **Prescriptive Controls**

1. The evacuation requirements of the development during flooding shall be considered in the Statement of Environmental Effects.
2. Reliable access for pedestrians or vehicles shall be provided from a minimum level equal to the lowest habitable floor level to an area of refuge above the PMF level. Where safe and practical this should involve evacuation to an area outside of the PMF extent.
3. The development shall be consistent with any relevant flood strategy, Floodplain
4. Risk Management Plan adopted by Council or similar.
5. The Applicant shall demonstrate that evacuation of potential development as a consequence of a subdivision proposal can be undertaken in accordance with the Flood Planning controls.
6. The Applicant shall provide a flood emergency response plan that demonstrates how risk to life will be managed during a flood event. For example, a safe evacuation route needs to be clearly identified, or a shelter in-place strategy with reliable access shall be provided to an area of refuge above the PMF level.

---

### **5.2.7 Management and Design**

#### **Performance Criteria**

1. The development should be designed and managed to ensure that during a flood valuable goods are capable of being protected.

**Prescriptive Controls**

1. The Applicant is to demonstrate that potential development as a consequence of a subdivision proposal can be undertaken in accordance with the DCP.
2. The Applicant is to demonstrate that an area is available to store goods above the 1% AEP flood level plus freeboard.
3. No storage of materials below the 1% AEP plus freeboard which may cause pollution or be potentially hazardous during any flood.
4. In-ground swimming pools are to have surrounding coping/tiling that is no more than 100 mm above surrounding ground level. All pumping/electricals are to be above the 1% AEP flood level plus freeboard.

---

**5.2.8 Fencing**

1. Fencing is to be constructed in a manner that does not obstruct the flow of floodwaters so as to have an adverse impact on flooding.

---

**5.2.9 All Other Areas**

- (a) For sites not in a 'flood planning area' habitable floor levels must comply with the drainage requirements of section 5.1 Stormwater Management and WSUD and as specified in the NCC.

**B6 ACCESSIBILITY AND ADAPTABILITY**

This section applies to all development excluding dwelling houses and other low-density residential development.

*Livable Housing Design Guidelines*

Livable Housing Australia drives industry best practice through the *Livable Housing Design Guidelines*. A livable home is designed and built to meet the changing needs of occupants across their lifetime. Livable homes include key easy living features that make them easier and safer to use for all occupants including: people with disability, ageing Australians, people with temporary injuries, and families with young children.

*Disability Discrimination Act 1992 (DDA 1992)*

The *DDA 1992* makes it unlawful to discriminate against a person with a disability in regards to the provision of access to public buildings for the provision of goods and services, accommodation and employment unless this would cause 'unjustifiable hardship'.

Where an applicant believes that complying with the DCP would cause "unjustifiable hardship," or detract from the significance of a Heritage Item, an application can be made to be exempted from a particular provision or to provide access for people with disabilities in some other way than provided for in the DCP. It is the responsibility of the applicant to ensure that the development meets the requirements of the *DDA 1992*.

*Access to Premises - Australian Standards*

Access to Premises - Australian Standards provides the technical specifications for access design requirements in the built environment. The Australian Standards clarify the accessibility requirements for premises as implied under the *DDA 1992* and are incorporated within the Building Code of Australia (BCA).

## 6.1 ACCESSIBILITY

### Objectives

- (a) To ensure that buildings and public spaces provide for equitable access for all, including people with a disability, ageing people with mobility difficulties, parents with prams, and other people with temporary disabilities.
- (b) To provide an accessible, continuous path of travel to all developments.
- (c) To provide equitable access within all developments.
- (d) To ensure major alterations and additions to existing buildings provides upgraded levels of access and facilities for all people.
- (e) To establish accessible dwelling standards for easy modification to cater for occupants with a disability or impairment.
- (f) To ensure that the siting, design and construction of premises available to the public are to ensure an appropriate level of accessibility, so that all people can enter and use the premises.

### Controls

#### *All Development*

- (a) Access is to meet the requirements of the *DDA 1992*, the relevant Australian Standards and the BCA.
- (b) Accessible parking for people with a disability must be provided in accordance with the *BCA* and *AS/NZS 2890.1: 2004 Parking Facilities – Off Street Parking* and *AS 1428: Set 2003* including *AS 1428.1:2009 Design for Access and Mobility*.
- (c) An Access Management Plan for alterations and additions to existing buildings only, may be required as a means of helping to provide services or facilities to people who would be unable to gain access to the premises.

#### *Commercial Development*

- (a) The main entrance should provide direct, level access from the street and from any parking area.
- (b) A lift must be provided at ground floor to upper floors in developments with three or more storeys and where aggregate floor area above the ground floor is 400m<sup>2</sup> or greater.

## 6.2 ADAPTABLE DWELLINGS

This section is to be read in conjunction with *Australian Standard AS 4299-1995 Adaptable Housing*.

### Objectives

- (a) To ensure adequate adaptable housing is provided for within new residential development to accommodate occupants' changing needs over time.
- (b) To ensure adaptable dwellings are included within residential development in accordance with the relevant Australian Standards.

### Controls

- (a) Plans identifying adaptable housing are to be submitted in accordance with the *Waverley Development Application Guide*.
- (b) Adaptable dwellings are to be allocated to all dwelling typologies to accommodate various household sizes.
- (c) In developments with 10 or more dwellings, 20% of dwellings (rounded to the nearest whole number) shall comply with the provisions of an adaptable unit as specified in accordance with the *Australian Standard AS 4299-1995 Adaptable Housing*.
- (d) One accessible car parking space is to be provided for every adaptable residential unit and be a part lot in the strata plan.

### 6.3 UNIVERSAL HOUSING DESIGN

A dwelling of universal design incorporates elements that are ‘designed in’ from the beginning, thus not requiring subsequent modification or adaptation through the lifecycle of occupants.

This section is to be read in conjunction with the *Livable Housing Design Guidelines* produced by Livable Housing Australia.

#### Objectives

- (a) To increase the supply of universal housing.
- (b) To ensure a suitable proportion of dwellings include universal design features to accommodate the changing needs of occupants over their lifetimes.
- (c) To promote sustainable development by extending the usability of a dwelling to meet ‘whole of life’ needs of the community. To ensure that residential accommodation includes universal design features as best practice.

#### Controls

- (a) All dwellings in any new medium or high density residential accommodation are to incorporate the universal design features as outlined below (modelled on the *Livable Housing Design Guidelines Silver Level*):
  - (i) A safe and continuous and step free path of travel from the street entrance and/or parking area to a dwelling entrance that is level;
  - (ii) At least one level entrance into the dwelling;
  - (iii) Internal doors and corridor widths that facilitate comfortable and unimpeded movement between spaces;
  - (iv) A toilet on the ground (or entry) level that provides easy access;
  - (v) A bathroom that contains a hobless (step-free) shower recess;
  - (vi) Reinforced walls around the toilet, shower and bath to support the safe installation of grab rails at a later date;
  - (vii) A continuous handrail on one side of any stairway where there is a rise of more than one metre; and
  - (viii) Stairways are designed to reduce the likelihood of injury and also enable future adaptation.
- (b) All universally designed dwellings must be clearly identified on the submitted DA plans. The incorporation of Gold and Platinum Level design features is strongly supported.



## 6.4 UNJUSTIFIABLE HARDSHIP

It is the responsibility of the applicant to ensure that the development meets the intent of the *DDA 1992*, and the requirements of the Premises Standards and this DCP. However, it is recognised under the *DDA 1992* that in some circumstances the provision of access may cause unjustifiable hardship by being unreasonable, impractical or uneconomical.

Where a developer believes that compliance with the provisions of this DCP and intent of the *DDA 1992* would cause unjustifiable hardship, an application can be made to Council to be exempted from a particular provision, or to provide access in some other way than that specified in this DCP. The information that must be supplied by the applicant is set out in detail under the Controls section of this Part.

In accordance with the *DDA 1992*, Council's assessment of an application for exemption will consider the extent to which people will benefit or be detrimentally affected by non-compliance with this DCP, the cost of compliance and the ability of the developer to meet the cost. Each claim will be considered by Council on its merits as there is no general formula that can be applied to guide what might be considered to be Unjustifiable Hardship.

It must be emphasised that there is always a requirement to provide whatever access is possible up to the point of unjustifiable hardship.

### Objectives

- (a) To have public buildings accessible to all people, consistent with requirements under the *DDA 1992* and the BCA.

### Controls

- (a) Claims of unjustifiable hardship will be considered on a case by case basis and on the merit of the case put forward by the applicant.
- (b) Unjustifiable hardship is not supported in new developments.
- (c) An application of unjustifiable hardship must be accompanied by a statement that includes the following information:
  - (i) The nature of the benefit or detriment likely to occur or be suffered by any persons in relation to the proposed development;
  - (ii) Two independent quotes from tradespeople or suppliers for the cost of works to meet the principles of the *DDA 1992*;
  - (iii) The space required to carry out works and the effect this may have upon the viability of the proposed work;
  - (iv) The impact on the heritage significance of the premises or conservation area (where applicable) and details of the work required to provide access;
  - (v) Typographical, technical, operational and safety issues;
  - (vi) Details of investigations into different ways in which the space could be configured or used so as to comply with the applicable access requirements; and
  - (vii) Details of investigations into design alterations so that future works to improve access are not compromised.

## B7 TRANSPORT

Car parking is one of the most critical planning and transport issues in Waverley. Wherever possible, Council strongly encourages the use of alternative modes of transport such as walking, cycling and public transport and continues to work towards providing better transport connections to the area.

The provision of private (on-site) and public (on-street) parking must be managed in an equitable and environmentally sensitive manner that benefits the community as well as the individual.

*Waverley's People, Movement and Places*

This Part has been prepared in the context of the Waverley Transport Plan 2017 '*Waverley's People, Movement and Places*.' The aim of *Waverley's People, Movement and Places* is to:

- Create a transit hierarchy for movement in the LGA that prioritises pedestrians and active transport, followed by public transport, service vehicles, shared mobility and private motor vehicles;
- Identify signature projects to invest in; and
- Identify short, medium, long term actions that Council can undertake.

**Objectives**

- (a) To prioritise trips taken by pedestrians, bicycles and other forms of active transport, followed by public transport, and private vehicles.
- (b) To ensure that new development promotes active and public modes of transport through car share facilities, end of trip facilities, and effective links to public transport.
- (c) To encourage reduced rates of car parking where adequate modes of public or active transport are available.
- (d) To ensure that parking and access do not dominate or adversely impact upon the character of the streetscape, landscape and the development.
- (e) To prioritise and maintain pedestrian amenity and safety.
- (f) To ensure on-street parking supply is protected by minimising impacts of additional vehicular kerb crossings.
- (g) To encourage on site car parking that considers flexibility in the design to allow easy transition to alternate uses in the future.
- (h) To discourage podium or above ground car parking.
- (i) To prevent on street car parking being utilised by occupants with allocated car parking bays.
- (j) To provide convenient and accessible parking that is appropriately designed and located.
- (k) To achieve a high standard of urban design and contribute to the amenity of streetscapes and landscapes.

## 7.1 STREETScape

### Objective

- (a) To ensure the provision of off-street parking is subject to considerations of urban design, streetscape and heritage conservation.
- (b) To balance car parking provision and access with urban design and amenity outcomes.

### Controls

- (a) A Streetscape Analysis is to be submitted in accordance with the *Waverley Development Application Guide*.
- (b) Where off street parking is not characteristic of the streetscape, vehicular access from the street is not permitted.
- (c) Car parking and vehicular access must not dominate the streetscape. Landscaping is to be used to soften the impact of such structures/areas.
- (d) Car parking and driveway design is to preserve mature or significant trees and vegetation on the site and in the surrounding streetscape. A significant tree refers to a tree identified on the Waverley Significant Tree Register, or a tree or vegetation that forms part of a Heritage Item or is within a Heritage Conservation Area.
- (e) Existing natural rock faces and heritage listed sandstone walls must not be removed for the purpose of car parking.
- (f) Entry gates and structures for car parking should be an open design to allow for improved security by way of street surveillance and to reduce any impact on the streetscape.
- (g) Parking structures are to maximise natural light and ventilation.
- (h) Separate and clearly differentiate pedestrian and vehicle access to the site.
- (i) Basement parking areas and structures:
  - (i) In Bondi Junction must not protrude above the level of the adjacent street or public domain;
  - (ii) In other areas, must not protrude more than 1.2m above the level of the adjacent street or public domain.
- (j) Where visible, basement structures and vent grills are to be integrated into the building and landscape design. Ventilation grills are to block views into basement areas and where possible be screened by landscaping in garden beds with a minimum soil plan depth of 1m.

**7.2 ON-SITE PARKING**

Waverley is divided into two Parking Provision Zones based on proximity to existing public transport services, proximity to services and where the provision of parking is constrained. These zones are summarised in Table 3 and available via Council’s Online Mapping Tool.

Waverley Online Mapping Tool	
<a href="https://planning.waverley.nsw.gov.au/connect/analyst">https://planning.waverley.nsw.gov.au/connect/analyst</a>	
Map Configuration	Planning
Layer	Parking Provision Zone

Parking Zone	Description	Location	Rate of Provision
1	High accessibility to public transport and services, high density and prone to traffic congestion.	Within 800m of Bondi Junction railway station where multi-residential development is permissible.	Low
2	Good to fair accessibility to public transport and services, mainly low and medium density, with some high density, and varied on-street parking pressures.	Properties outside Zone 1.	Moderate

**Table 3** Parking Provision Zones

**Objectives**

- (a) To ensure on-site parking is usable, safe and integrated into the design of the building.

**Controls**

- (a) Car park design must be in accordance with relevant Australian Standards.
- (b) Car space dimension, driveway grades, vehicular ramp width/grades and passing bays must be in accordance with the relevant Australian Standards. Vehicular ramps less than 20m long within developments and parking stations must have a maximum grade of 1 in 5 (20%).
- (c) Vertically stacked parking is only permitted where site constraints (such as horizontal dimensions or vertical relief) prevent full provision of conventional parking.
- (d) Stacked parking spaces are to comply with the dimensions for individual spaces and are not acceptable for visitor parking. The templates provided in Australian Standards indicate the paths swept by maneuvering vehicles and must be used by applicants to design access to parking and loading facilities. A minimum clearance of 300mm between the swept path and any building and obstruction is to be maintained.
- (e) Consolidate basement car parking areas under building footprints to maximise the area available for soft landscaping.
- (f) Design parking structures that minimise reliance on artificial lighting and mechanical ventilation.
- (g) Provide marked pedestrian pathways with clear lines of sight and safe lighting.

- (h) Parking areas must not be located within the front building setbacks for new development.

---

### 7.2.1 Vehicle Access

#### Objectives

- (a) To prioritise pedestrian movements and the public domain over vehicular access.
- (b) To design vehicle access to required safety and traffic management standards.
- (c) To minimise the impact of vehicle access points and driveway crossovers to retain streetscape continuity and reinforce a high quality public domain.
- (d) To ensure vehicle entry points are integrated into building design and contribute to high quality architecture.
- (e) To integrate vehicle access with site planning and local traffic patterns.
- (f) To minimise potential conflict between vehicles and pedestrians.
- (g) To minimise the size and quantity and visual intrusion of vehicle access points.

#### Controls

- (a) One vehicle access point per development (including any access for service vehicles and parking for non-residential uses within mixed use developments) is permitted.
- (b) Vehicle access is to be from lanes and secondary streets where available, and not from primary street fronts or streets with major pedestrian activity.
- (c) Vehicle access points are to be integrated into the building design.
- (d) Vehicle access is to be designed to minimise the impact on the street, site layout and the building façade design.
- (e) Doors to vehicle access points are to be tilting doors fitted behind the building façade and to be of materials that integrate with the design of the building and contribute to a positive public domain.
- (f) Vehicle entries are to have high quality finishes and detailing. No service ducts or pipes are to be visible from the street.
- (g) Vehicle access may not be required for, or may be denied to some heritage buildings.
- (h) New developments are to utilise existing vehicle access points in adjoining developments where possible.
- (i) New developments are to provide vehicle access points that are capable of underground shared access at a later date. Internal on-site signal equipment is to be used to allow for safe shared access.
- (j) Vehicle access should be:
  - (i) Located taking into account any services within the road reserve, such as power poles, drainage inlet pits and existing street trees.
  - (ii) Located a minimum of 10m from the perpendicular of any intersection of any two roads.
  - (iii) Locate vehicle access a minimum of 3m from pedestrian entrances.
- (k) Wherever practicable, vehicle access is to be a single lane crossing with a maximum width of 2.7m over the footpath, and perpendicular to the kerb alignment. In exceptional circumstances, a double lane crossing with a maximum width of 5.4m may be permitted for safety reasons.
- (l) Driveway widths must comply with the relevant Australian Standards.
- (m) Car space dimension, driveway grades, vehicular ramp width/grades and passing bays must be in accordance with the relevant Australian Standards. Vehicular

ramps less than 20m long within developments and parking stations must have a maximum grade of 1 in 5 (20%).

- (n) Vehicle access ramps parallel to the street frontage will not be permitted.
- (o) Vehicular access must not ramp along boundary alignments edging the public domain, streets, lanes parks, water frontages and the like.
- (p) Access ways to underground parking should not be located adjacent to doors or windows of the habitable rooms of any residential development.
- (q) Access ways and driveways are to enable vehicles to enter the parking space in a single movement, and to leave the space in a maximum of two turning movements.

---

### 7.2.2 Car Parking Provision Rates

#### Objectives

- (a) To provide car parking rates which reflect the proximity of development to existing public transport, services and the availability of on-street parking.
- (b) To balance the need to meet parking demand on site with the need to contain parking and promote sustainable transport.
- (c) To establish controls for parking that reflect the characteristics of the area in terms of urban form, land use and proximity to public transport.

#### Controls

- (a) Approval for on-site parking will only be granted where the site and locality conditions permit.
- (b) Car parking must be designed to complement the design of the building and streetscape to which it relates and incorporate a range of appropriate materials and design.
- (c) Car parking structures are to be located behind the front building line to reduce visual impact upon the streetscape.
- (d) Driveways and vehicular access should be designed to minimise the loss of on-street parking wherever possible.
- (e) Car park access is to be provided from secondary streets or lanes where possible.
- (f) Adjacent properties are to share driveways and vehicle crossings where possible to minimise service entries and increase safety for pedestrians.
- (g) Where a DA involves a change of use, the parking rate for the new use is to be calculated as the difference between the parking rates required for both the present and proposed uses (under this Part). Council reserves the right to require a parking provision rate based on the total requirement for the use if, in its opinion, the DA involves a re-construction of the building.
- (h) When calculating the provision of parking spaces or loading facilities, the following method is to be applied:
  - (i) The number of spaces for each use on the site is to be calculated separately; and
  - (ii) The total number of facilities or spaces to be provided is to be rounded to the nearest whole number, i.e. 2.15 spaces equals a requirement for 2 spaces and 2.50 spaces equals a requirement for 3 spaces.

Car parking rates are based on the *RMS Guide to Traffic Generating Developments*, and are provided in Table 4.

- (i) For developments requiring more than 50 car parking spaces, a maximum of 2% of the required parking spaces may be specified as "small car spaces", with a minimum length of 5 metres. Such spaces are to be indicated on the plans submitted and clearly indicated when completed.
- (j) Council may also require on-site parking provision be reduced or removed for development fronting secondary streets or laneways in Centres to achieve the relevant objectives of *Part E Site Specific Development*. The exact reduction in on-site parking provision will be determined by Council on a case-by-case basis. Developments that have a single frontage to a primary street will not be permitted on-site parking.

**Note:** Gross Floor Area is defined as per the definitions in the WLEP, with ‘car parking’ and ‘access to that car parking’ in the WLEP definition referring to the minimum dimensions and access required in order to comply with requirements of AS2890 and the National Construction Code (NCC) – Building Code of Australia (BCA). Car parking spaces above the ‘maximum’ stated in the below table, and components of parking and access areas greater than the minimum dimensions required to meet the AS2890 and the BCC/BCA will contribute to the Gross Floor Area calculation.

Land Use	Parking Zone 1	Parking Zone 2
<b>Private Vehicle Parking</b>		
<i>Low Density Residential parking space rate per dwelling</i>	≤2 Bedrooms – <i>Maximum 1</i> ≥3 Bedrooms – <i>Maximum 2</i>	≤2 Bedrooms – <i>Maximum 1</i> ≥3 Bedrooms – <i>Maximum 2</i>
<i>Medium density residential (3-19 dwellings) parking space rate per dwelling</i>	<i>Minimum - 0</i>  <i>Maximum</i> Studio 0 1 bedroom 0.4 2 bedroom 0.7 3 bedroom + 1.2	<i>Minimum - 0</i>  <i>Maximum</i> 0 1.0 1.2 1.5
Visitor	1 space per 7 units	1 space per 5 units
<i>High density residential (20+ dwellings) parking space rate per dwelling</i>	<i>Minimum - 0</i>  <i>Maximum</i> Studio 0 1 bedroom 0.4 2 bedroom 0.7 3 bedroom + 1.2	<i>Minimum - 0</i>  <i>Maximum</i> 0 0.6 0.9 1.4
Visitor	1 space per 7 units	1 space per 5 units
<i>Business and office premises</i>	Minimum 0 Maximum 0.66/100m <sup>2</sup> GFA	Minimum 0 Maximum 1.0/100m <sup>2</sup> GFA
<i>Retail premises</i>	Minimum 0 Maximum 2.0/100m <sup>2</sup> GFA	Minimum 0 Maximum 3.3/100m <sup>2</sup> GFA
<b>Other Parking</b>		
<i>Motorcycles</i>	1 motorcycle parking bay per 3 car parking bays (including visitor)	
<i>Car Share</i>	A minimum of 1 car share space is to be provided for every 90 residential units. A minimum of 1 car share space be provided for every 50 commercial car parking spaces. 1 car share space can be provided in lieu of 4 car spaces.	
<i>Accessible Car Parking Spaces</i>	A minimum of 1 accessible car parking space is to be provided for every adaptable residential unit and be a part lot in the strata plan.	

	For non-adaptable residential units, if car parking spaces are provided, then a minimum 10% of all car spaces need to be accessible car parking spaces.
--	---

**Table 4** Car Parking Rates



### 7.2.3 Variations to Parking Rates

- (a) Variations to the relevant parking standards will only be accepted where the applicant can demonstrate that the requirement cannot be reasonably achieved (provision of less than the standard); or that exceeding the standard is in the public interest.

Matters that the Council may consider in assessing variations include, but are not limited to, any of the following as are relevant:

- Particular site design requirements such as setbacks, landscaping, solar access and streetscape controls.
- Site and building constraints such as the physical and topographical nature of the site.
- Impacts of any increased building bulk on the streetscape or adjoining land, including overshadowing and loss of views.
- Compliance with deep soil landscape area requirements (side and rear boundary setbacks).
- Impacts of excavation, including land form, structural integrity of buildings and structures on adjoining land, and stability of land on the subject site and adjoining sites.
- Impacts from any increase in hard surface driveways and the building footprint on the availability of water permeable ground spaces.

- (b) Variations to the car parking standards will only be supported where the applicant can demonstrate that the development is unlikely to create significant additional demand for on-street car parking in surrounding streets.

When a development application seeks to vary the car parking provisions, the following priority is to be adopted:

1. Residential parking
2. Visitor parking
3. Commercial Parking (i.e. business, office, retail).

---

## 7.2.4 Parking for Low Density Residential Development

### Controls

- (a) For new dwellings, car parking should not exceed the rates outlined in Table 4.
- (b) Notwithstanding the above, a reduced rate (or no parking) may be required in the following circumstances, where:
  - (i) Parking may have a detrimental impact on the character of the streetscape, heritage item or heritage conservation area, or health of a mature or significant tree.
  - (ii) A driveway cannot comply with maximum gradients and design standards required by the Australian Standards.
  - (iii) Vehicle entry and exit may have a detrimental impact on pedestrian and traffic movements and safety or nearby services or infrastructure.
  - (iv) The access to the on-site car parking will result in the loss of more than 1 on-street car parking space.
  - (v) There is low on-street parking availability and no net car parking public benefit.
- (c) Where an applicant proposes to provide more than the number of on-site car spaces specified in (a) the additional spaces will contribute to the Gross Floor Area calculation and additional justification must be provided to cover matters such as, but not limited to the impact of:
  - (i) Parking compared to alternatives such as landscaping;
  - (ii) Any increased building bulk on the streetscape;
  - (iii) Any increased building bulk on the amenity of adjoining properties;
  - (iv) The loss of existing on-street parking illustrating existing and proposed off street parking;
  - (v) The level and impact of any excavation; and
  - (vi) Access to public transport.

---

## 7.2.5 Motorcycle parking

### Objectives

- (a) To encourage alternative forms of transport.
- (b) To ensure the quantity of motorcycle parking available is enough to meet growing demand.

### Controls

- (a) Motorcycle parking spaces are to have dimensions of 1.1m x 2.5m.
- (b) Motorcycle parking is to be provided in accordance with Table 4.
- (c) Motorcycle spaces are to be indicated on the plans submitted, and clearly identified for motorcycle use only when the development is completed.

### 7.2.6 Bicycle Parking

This part should be read in conjunction with *AS2890.3.2015 Parking Facilities – Part 3: Bicycle parking* and the *Bicycle Parking Facilities: Updating the Austroads Guide to Traffic Management*.

#### Objectives

- (a) To provide safe and convenient end of trip facilities for residents as well as commuters and employees.
- (b) To ensure the quantity of bicycle parking available is sufficient to meet growing demand.
- (c) To promote cycling as a healthy and environmentally friendly way to make commuter, shopping and recreational trips.

#### Controls

- (a) Parking for bikes is to be provided at the minimum rates outlined in Table 4, except where an apartment in a residential building has a basement storage area on title that is large enough to accommodate a Class 1 bike locker.
- (b) Areas for bicycle parking will not be included as part of gross floor area or gross leasable area (GLA) for the purpose of calculating car parking provision.
- (c) Council reserves the right to require a greater provision of bicycle parking than indicated in Table 5, where in Council's opinion, the particular nature of the development will generate an increased demand for bicycle parking.
- (d) Bike parking is to be provided in accordance with requirements for layout, design and security as set out in the Australian Standard *AS 2890.3 -1993 Parking facilities – Bicycle parking facilities*, including:
  - (i) Security Class 1 bike lockers for occupants of residential buildings;
  - (ii) Security Class 2 bike enclosures for staff/employees of any land use; and
  - (iii) Security Class 3 bike rails/ racks for visitors of any land use.
- (e) Bicycle parking is to be located:
  - (i) Close to street level entry/exit points; and
  - (ii) Subject to security camera surveillance where such security systems exist.
- (f) A safe path of travel from bike parking areas to entry/exit points is to be marked.
- (g) Access to bike parking areas are to be:
  - (i) A minimum of 1.8m wide to allow pedestrians and bikes to pass each other (access ways can be shared with vehicles within buildings and at entries to buildings);
  - (ii) Accessible via a ramp;
  - (iii) Clearly identified by signage; and
  - (iv) Accessible via appropriate security / intercom systems.
- (h) Bicycle parking for visitors is to be provided in an accessible on-grade location near a major public entrance to the development and is to be signposted.
- (i) For retail premises provide minimum 50% of the required bicycle parking at an accessible location near the entry to the retail premises.
- (j) For non-residential uses, the following additional end-of-trip facilities are to be provided at the following rates:
  - (i) 1 personal locker for each bike parking space;
  - (ii) 1 shower/change cubicle for up to 10 bike parking spaces;
  - (iii) 2 shower/change cubicles for 11 to 20 bike parking spaces are provided;

- (iv) 2 additional showers/cubicles for each additional 20 bike parking spaces or part thereof.
- (k) Locker, change room and shower facilities are to be located close to the bike parking area, entry/exit points, and within an area of security camera surveillance where there are such building security systems.

Land Use	Bicycle Parking Rates	
	Long-stay / resident/ employee	Short-stay/ Visitor
Residential Development	<i>All residential development</i> 1 space per dwelling	<i>Medium and High Density (3+ dwellings)</i> 1 space per 10 dwellings
Office	<i>Employee</i> 0.45 spaces per 100m <sup>2</sup> GFA	<i>Visitor</i> 1 space per 2000m <sup>2</sup> GFA
Retail	<i>Employee</i> 0.1 spaces per 100m <sup>2</sup> NFA	<i>Visitor</i> 0.4 spaces per 100m <sup>2</sup> GFA
Education (primary, secondary, tertiary)	<i>Employee</i> 0.3 spaces per staff	<i>Student</i> 0.3 spaces per student
Tourist Accommodation	<i>Staff and Long Stay</i> 0.1 spaces per staff / long stay visitor	<i>Visitor</i> 1 space per 10 units
Places of assembly / sports facilities / community centres	<i>Staff</i> 0.1 spaces per staff	<i>Visitor</i> 0.1 spaces per seat
Food and drink premises	<i>Staff</i> 0.1 spaces per staff	<i>Visitor</i> 0.1 spaces per seat
Healthcare, Childcare, Other	<i>Staff</i> 0.1 spaces per staff	<i>Visitor</i> 0.05 spaces per visitor

**Table 5** Bicycle parking rates

**7.3 LOADING FACILITIES**

**Objectives**

- (a) To balance parking and loading requirements.
- (b) To provide for adequate loading/unloading facilities without impacting upon amenity and safety.
- (c) To ensure that adequate off street loading and servicing facilities are to be provided for all development where regular delivery of goods are made to or from the site.
- (d) To ensure that the number of loading bays to be provided is appropriate for the scale and type of the use proposed.

**Controls**

- (a) Loading and unloading facilities should be available for all commercial premises. These facilities are to be provided on-site where the provision of such will not adversely affect the character of the streetscape, pedestrian safety or amenity. A nearby off-site loading bay may be negotiated to minimise adverse impacts.
- (b) Where possible access to a loading facility must be provided via a laneway or secondary frontage.
- (c) The number of loading bays shall be determined having regard to the scale and type of uses proposed. In this regard, details of anticipated volumes and frequency of deliveries is to be provided within the Statement of Environmental Effects submitted with the DA. Table 6 provides for minimum loading requirements.
- (d) The following design principles should be considered in the design of loading facilities including:
  - (i) The size and layout of the service area must be designed to facilitate operations relevant to the development;
  - (ii) A service area must be a physically defined area not used for other purposes, such as storage of goods and equipment or parking;
  - (iii) All vehicles must enter and exit the property in a forward direction;
  - (iv) Internal circulation must be adequate for the largest vehicle anticipated to use the site; and
  - (v) Loading facilities must be designed to comply with the requirements of *AS 2890.2 -2002 Part 2: Off-Street Commercial Vehicle Facilities*.
- (e) A development application shall include the following:
  - (i) The class and dimensions, including height, of the design vehicle accessing the service area.
  - (ii) Clearance heights between the access driveway and the loading dock(s).
  - (iii) The dimensions of the loading dock(s).
  - (iv) Swept wheel paths between the access driveway and the loading dock and the required maneuvering areas for both entry and exit movements.

Use	Rate
Offices, commercial premises & professional consulting rooms	1 per 4000m <sup>2</sup> up to 20,000m <sup>2</sup> plus 1 per 8000m <sup>2</sup> thereafter
Residential flat buildings	1 per 50+ dwellings
Retail	1 per 400m <sup>2</sup> GFA
Other uses	Merit Assessment

**Table 6** Minimum Commercial Loading Rates

**7.4 PEDESTRIAN/BICYCLE CIRCULATION AND SAFETY****Objectives**

- (a) To ensure priority is given to pedestrian and bicycle movements.
- (b) To maintain bicycle and pedestrian safety.
- (c) To provide safe and easy access to buildings.
- (d) To provide a safe and accessible public domain.

**Controls**

- (a) The location of parking spaces is not to obstruct pedestrian and bicycle access to the premises or major pedestrian and cycling routes.
- (b) Within parking areas of more than 10 car spaces, segregated routes for main pedestrian and bicycle movements must be created making use of line marking, pedestrian crossings, signage and where appropriate speed humps.
- (c) Provide safe lighting during the day and night. Utilise motion sensors to minimise power consumption.
- (d) Exit points of parking areas of more than 10 car spaces require the following safety devices installed within the boundary of the property:
  - (i) Two stop signs;
  - (ii) A white, unbroken line at the exit point appropriate to accompany stop signs;
  - (iii) Two fish eye mirrors to improve sighting of pedestrians traversing the public footpath area;
  - (iv) Either a boom gate or a speed hump, or both, within 8 metres of the exit point; and
  - (v) Clear signage and enforcement of an 8 km per hour speed limit and vehicles' lights being left on within the property.

## 7.5 GREEN TRAVEL PLANS

A Green Travel Plan is a package of actions designed to encourage safe, healthy and sustainable travel options. By reducing car travel, Green Travel Plans can improve health and wellbeing, free up car parking space, and make a positive contribution to the community and the environment.

### Objective

- (a) To reduce car dependency and encourage safe, healthy and sustainable travel options.
- (b) To remove barriers to active travel for all users of developments.
- (c) To maximise the number of people who walk, cycle or take public transport to and from the development.

### Controls

- (a) A Green Travel Plan or Workplace Travel Plan is mandatory for all developments:
  - (i) With over 2,500m<sup>2</sup> for office / commercial/ retail land uses;
  - (ii) Including 15 units or more;
  - (iii) Where 50 or more employees are proposed; or
  - (iv) As deemed necessary by Council.
- (b) A Green Travel Plan must include:
  - (i) Targets – this typically includes the reduction of a single occupant car trips to the site for the journey to work and the reduction of business travel.
  - (ii) Travel data – an initial estimate of the number of trips to the site by mode is required.
  - (iii) Measures – a list of specific tools or actions to support and achieve the targets.

For further information on how to prepare a Green Travel Plan or Workplace Travel Plan go to: [www.pcal.nsw.gov.au](http://www.pcal.nsw.gov.au) and [www.travelsmart.gov.au](http://www.travelsmart.gov.au) and the Sustainable Transport Calculator from the Green Building Council of Australia Design & As Built Tool.

## 7.6 TRAFFIC AND TRANSPORT MANAGEMENT PLANS

A Traffic and Transport Management Plan sets out the procedures to mitigate and minimise the impacts of the development (both construction and operation) on the capacity, performance and safety of the local road network and traffic systems and also addresses the impacts on pedestrians, public transport, parking and cyclists.

### Objectives

- (a) To ensure an adequate assessment is made of the traffic and parking impacts of development on the surrounding road network and adequate measures to ameliorate the impacts are considered.

### Controls

- (a) A traffic and transport management plan is required to accompany a development application for the following developments:
  - (i) Child care centre;
  - (ii) Residential development over 15 units or more;
  - (iii) Commercial development with over 2,500m<sup>2</sup>; or
  - (iv) Other development at the discretion of Council.
- (b) The study should provide an assessment of the traffic and parking impacts the development proposal may have on the surrounding road network and must address matters such as:
  - (i) Current on street parking restrictions and availability;
  - (ii) Time of peak demand;
  - (iii) Proportion of people using facilities on site;
  - (iv) Hours of operation;
  - (v) Current traffic conditions;
  - (vi) The likely impact of the proposed development on existing traffic flows and the surrounding street system;
  - (vii) Safety of pedestrian and vehicular movements in and around the centre;
  - (viii) How impacts of drop-off and pick up will be accommodated; and
  - (ix) Deliveries to the site.



## 7.7 CAR SHARE

### Objectives

- (a) To provide off-street parking opportunities for car share groups, in balance with competing parking demands.
- (b) To support alternative methods of transport and reduce the demand on private car ownership.
- (c) To reduce the reliance on private vehicles and the corresponding traffic impact on the road network.
- (d) To increase uptake and awareness of car share schemes.
- (e) To encourage share car schemes to locate within developments to provide easy access for residents and workers.

### Controls

- (a) The maximum amount of car parking spaces for a development is inclusive of car sharing spaces.
- (b) Car share parking spaces must be publicly accessible at all times, adequately lit and sign posted and located off the street.
- (c) Car share spaces must be in optimum positions within the parking area to allow ease of access to car share vehicles by residents and the public.
- (d) Where appropriate, Council may consider the provision of on-street car share spaces in lieu of car parking on site.
- (e) Car share spaces must always be under the ownership of a building's Owners' Corporation as common property.
- (f) Car share spaces must be used and have authorised use by car share vehicles only.
- (g) If a car share space is not taken up by a genuine car share provider, the space cannot be permanently or temporarily designated for alternative purposes.

## 7.8 ELECTRIC VEHICLE CHARGING POINTS

### Objectives

- (a) To prepare future buildings for the requirements of electric vehicles.

### Controls

- (a) Electric vehicle chargers and Electric Vehicle Ready infrastructure should be installed as per the rates and specifications in Table 7.
- (b) Electric Vehicle Distribution Boards should be installed to achieve the requirements in Table 7.
- (c) All charging point locations are to be identified on CC Plans.
- (d) All charging points are to have clear signage identifying location, any fees and charges and whether the bay is for public or private use only.
- (e) Charging stations should allow for monitoring and individual billing payment through an Open Charge Point Protocol compatible software back end and NMI registered electricity meters.
- (f) All mixed use, commercial and residential flat building development with on-site car parking should provide at least 1 dedicated space and charging point to be used for electric bicycles and mobility scooters.

### Definitions

- Electric Vehicle Ready: a dedicated circuit and cable storage for each parking space with power demand management system to enable all circuits to be used simultaneously.
- Electric Vehicle Distribution Board: a distribution board dedicated to EV charging that is capable of supplying at least 50% of EV connections at full power at any one time during off peak periods. The distribution board will be complete with an EV Load Management System and an active suitably sized connection to the main switchboard.
- Charging Station: an electric vehicle charging station with a minimum power output of 7kW single phase.

Building Class	Car Space Type	Minimum Charging Stations Installed (% of spaces)	Minimum Number of EV Ready Spaces (%)	Minimum Current per Space (A)	Minimum Energy Capacity per Space Day = 9am-5pm Night = 11pm-7am (kWh)
Low density residential	Resident	0	100	16	Night 24
Medium and high density residential (3 + dwellings)	Resident	20	100	16	Night 15
	Visitor	100	100	32	Day 15
Boarding houses, co-living, hostels, hotels, motels	Any	20	40	32	Night 48
Business and office premises	Any	20	40	32	Day 15

Retail premises	Any	20	40	32	Day 15
Other premises	Any	20	40	32	Day 15

**Table 7** Specifications for electric vehicle chargers, Electric Vehicle Ready infrastructure and Electric Vehicle Distribution Boards. *Note: Requirements are to be rounded to the nearest whole number.*

## B8 HERITAGE

This Part applies to all land identified, and land adjacent to site identified, under Schedule 5 of WLEP where development consent is required.

Applicants are advised to refer to the *Waverley Heritage Policy*.

Where there are inconsistencies between this Part and other Parts of this DCP, this *Part B8 Heritage* will prevail. For development within the Charing Cross and Queens Park Heritage Conservation Areas, also refer to Annexures B8-1 and B8-2.

This DCP is consistent with the Australia International Council on Monuments and Sites (ICOMOS) Charter for Conservation of Places of Cultural Significance (The Burra Charter). In the event of any inconsistencies between the Burra Charter and this DCP, this DCP will prevail.

### *State Heritage Listing*

The State Heritage Register maintained by the NSW Department of Planning and Environment Heritage Branch includes items of Local and State Significance. Works to items identified as being of State Significance require a submission to the NSW Heritage office in conjunction with submission of a Development Application to Council.

### *Listings with the National Trust of NSW*

Where a building or conservation area is also listed by the National Trust, it is Council's practice to refer applications to the Trust for comment. Council will consider submissions made by the National Trust however; Council is not obliged to follow the Trust's advice.

### *National Heritage Register*

Where a place or object is included in the Register of the National Estate, Council is the designated consent authority for all identified buildings.

## **General Objectives**

- (a) To provide a framework for heritage and conservation planning in Waverley.
- (b) To provide detailed guidelines to manage change and ensure the preservation of history and heritage in Waverley.
- (c) To ensure that appropriate heritage documentation is provided to inform the assessment of development.
- (d) To ensure that Aboriginal heritage and archaeology are taken into consideration, and respectfully incorporated where appropriate.
- (e) To ensure that development enhances the character and significance of any heritage item, conservation area, artefact or place.
- (f) To ensure development reflects and promotes an understanding and appreciation of heritage significance.
- (g) To promote sustainable development through the retention and repurposing of existing building stock.

## 8.1 DEFINING HERITAGE

### 8.1.1 Heritage Items

A heritage item has cultural significance meaning aesthetic, historic, scientific and / or social value for future generations. All heritage items have been assessed as having significance under the criteria established by the NSW Heritage Branch of the Department of Planning and Environment. The basic criteria of assessment include historic, aesthetic, scientific and social significance, rarity and association with institutions, groups or individuals of importance to the community.

Council supports the retention of heritage items in their significant form and setting whilst allowing sympathetic development to occur. As significance includes the setting, grounds and often the interior of buildings these aspects must be addressed in development applications.

Where new buildings or new building work is to be carried out in the context of a heritage site it is important that the character, quality and value of the setting, streetscape and listed item be maintained.

### 8.1.2 Heritage Conservation Areas

A Heritage Conservation Area contains a group of buildings where historical origins and relationships between various elements create a distinctive character of heritage. The heritage significance may include subdivision and street pattern, form and scale, the consistency of building materials or the common age of the building stock.

Heritage Conservation Areas often contain both Contributory Items and Non Contributory Items. Heritage Conservation Areas respond to natural features including topography, vegetation and views. Such features are considered contributory to the cultural significance of the Heritage Conservation Area and are acknowledged as contributory items. Note, definitions are included at the end of this DCP.

Council encourages the alteration and or replacement of Non Contributory Items in a manner enhancing the defined heritage significance of the Conservation Area. The existence of non-contributory items in a Conservation Area is not considered a basis for the introduction of development which is not cohesive with the identified significance of the Conservation Area.

All new development in a heritage conservation area is treated as 'infill development.' Details of Waverley's Heritage Conservation Areas are provided on Council's website.

### 8.1.3 Landscape Items and Landscape Conservation Areas

A substantial number of items in Waverley are identified as having Landscape Heritage Significance. These include natural and manmade or cultivated elements both of planted and non-biological forms. Landscape Items and Landscape Conservation Areas are to be treated as are other identified heritage items or conservation areas with any development

required to maintain and enhance the significance of the landscape item or conservation area.

---

#### **8.1.4 Archaeological Sites**

Evidence of past indigenous and non-indigenous land use remains throughout Waverley. Evidence located below ground or concealed within later works is identified as an archaeological site. Many of these sites are identified on the basis of previous land uses providing the potential for discovery of archaeological evidence of past activities. Others contain known subterranean deposits or artefacts identified in the listing.

## 8.2 DEMOLITION & EXCAVATION

Demolition requires Council consent and supporting documentation in accordance with the Heritage Act 1977.

### Objectives

- (a) To ensure both listed items and buildings which contribute to the significance and character of Heritage Conservation Areas are conserved.
- (b) To discourage demolition so as to preserve the value of heritage items and Heritage Conservation Areas for the local community.
- (c) That replacement development enhances the character of the conservation area.

### Controls

- (a) Unless identified alternately, heritage listing of buildings encompasses the whole building and site including outbuildings and boundary enclosures.
- (b) Demolition of a heritage item or contributory building in a conservation area will generally not be supported, unless there are overriding reasons such as extreme structural damage.
- (c) Demolition of a non-contributory building that detracts from a Conservation Area and replacement with an appropriately designed infill building is generally supported provided the proposed infill development is consistent with the objectives and controls outlined in this Part.
- (d) Excavation beneath and/or adjacent to heritage items and/or buildings in heritage conservation areas will only be permitted if it is supported by both a Geotechnical Engineering report and a Structural Engineering report.
- (e) Excavation will not be permitted if:
  - (i) It will occur under common walls and footings to common walls, or freestanding boundary walls, or under any other part of adjoining land; or
  - (ii) It will occur under or forward of the front facade.

### 8.3 ABORIGINAL SITES

The *National Parks and Wildlife Act 1974 (NPW Act)* is the primary legislation for the protection of some aspects of Aboriginal cultural heritage in New South Wales. Under the *NPW Act*, anyone carrying out an activity must exercise due diligence to determine whether they should apply for consent in the form of an Aboriginal Heritage Impact Permit (AHIP).

The Due Diligence Code of Practice for the Protection of Aboriginal Objects in New South Wales sets out the steps to be taken in order to:

- Identify whether or not Aboriginal objects are, or are likely to be, present in an area
- Determine whether or not activities are likely to harm Aboriginal objects (if present)
- Determine whether an application for an AHIP is required.

A number of Aboriginal cultural heritage sites occur within Waverley and have been included within the WLEP. Further information on Waverley's Aboriginal Cultural Heritage can be found in the Waverley Aboriginal Cultural Heritage Study on the Council website.

As per WLEP clause 5.10, development consent is required to disturb or excavate an Aboriginal place of heritage significance, land known to contain Aboriginal objects, or land which is suspected to contain Aboriginal objects. This Part provides controls to ensure the ongoing management of these sites (refer to Figure 20).

#### Objectives

- (a) To effectively manage and protect currently identified Aboriginal heritage sites.
- (b) To protect any undetected aboriginal heritage sites.

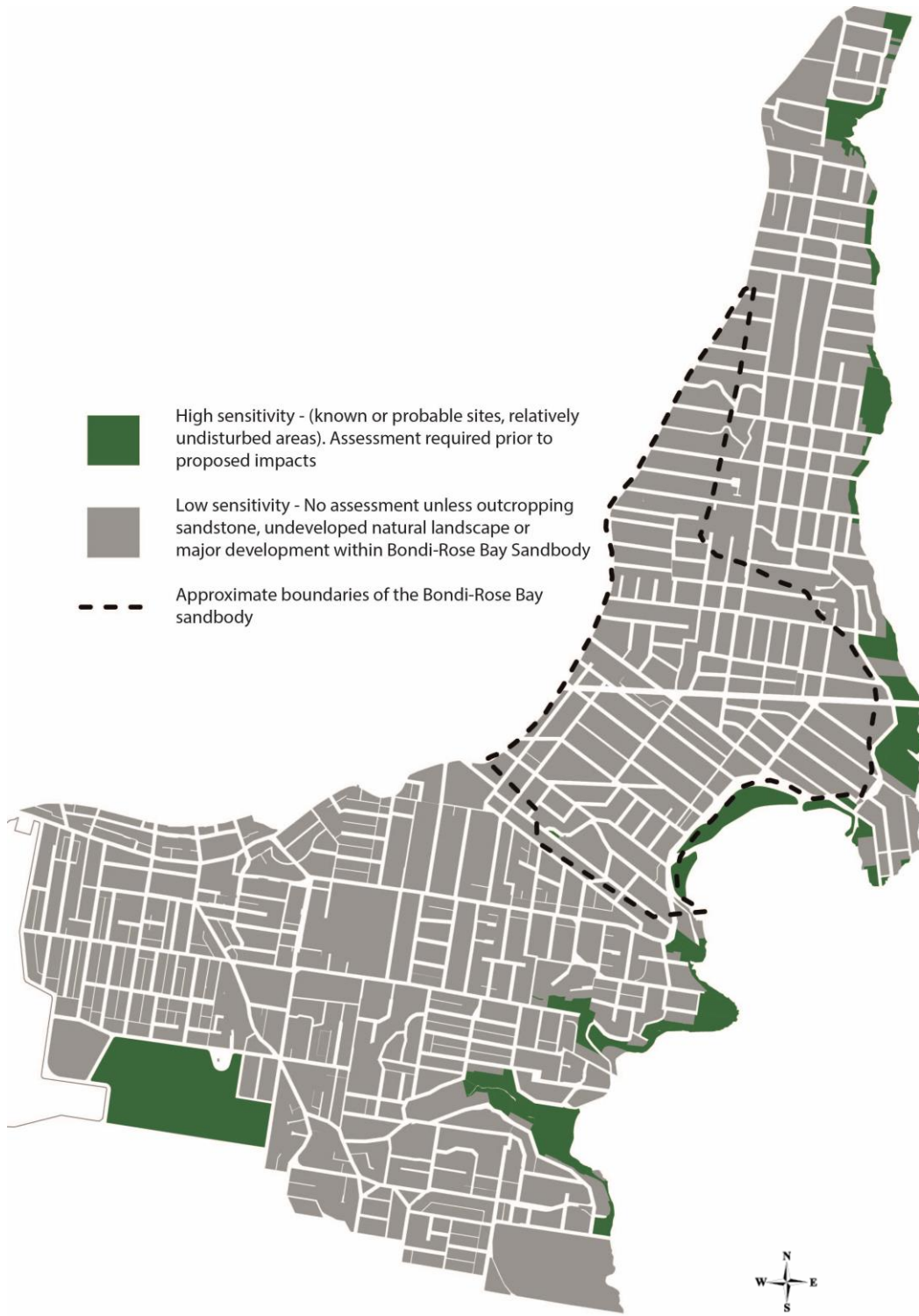
#### Controls

- (a) Development on land where there is an identified Aboriginal object as identified in WLEP; is likely to be an Aboriginal object; or is an Aboriginal place of heritage significance; must be supported by an Aboriginal cultural heritage assessment prepared in accordance with the requirements of the *NPW Act* and include appropriate recommendations to inform the long term management of the item of significance.
- (b) Development must be in accordance with Table 8.
- (c) An applicant must refer to the *NPW Act* should an Aboriginal object(s) be discovered when undertaking development.



Site category	Action required
<p>High sensitivity: Sites identified in the LEP as containing an Aboriginal object or Aboriginal Place of heritage significance, or relatively undisturbed areas where artefacts are most likely located.</p>	<p>(a) Due diligence must be exercised to determine whether an AHIP is required. (b) Development consent required.</p>
<p>Low sensitivity: Any area with outcropping sandstone, undeveloped natural landscape or the Bondi Rose-Bay Sand body.</p>	<p>(c) Due diligence must be exercised to determine whether an AHIP is required.</p>
<p>Little likelihood: All areas not included in one of the categories above.</p>	<p>(d) No pre-emptive action required.</p>

**Table 8:** Guideline for Aboriginal Cultural Heritage and Development



## 8.4 HERITAGE CONSERVATION AREAS

### Objectives

- (a) To promote high quality design that respects and enhances the heritage significance of the conservation area.
- (b) To ensure that development respects the original built form, architectural style and character of the conservation area.
- (c) To ensure that contributory items are retained and improved.
- (d) To promote development that will remove uncharacteristic items, or reduce the extent of their intrusion.

### Controls

- (a) Development must demonstrate that it achieves any recommendations for the area as detailed in *Annexure B8-1*.
- (b) Development is to be compatible with the surrounding built form and urban development pattern by addressing the Statement of Significance outlined in *Annexure B8-1*.
- (c) A Context and Streetscape Analysis is to be provided that identifies common elements and features of the area including:
  - (i) Topography and landscape;
  - (ii) Views to and from the site;
  - (iii) Significant subdivision patterns, layout, front and side setbacks;
  - (iv) The type, siting, form, height, bulk, roofscape, scale, materials and details of adjoining or nearby contributory buildings;
  - (v) The interface between the public domain and building alignments and property boundaries; and
  - (vi) Colour schemes that have a hue and tonal relationship with traditional colour schemes.
- (d) Contemporary design is encouraged and is to incorporate the elements and features as identified in the Context and Streetscape Analysis.
- (e) New development is not to be designed as a copy or replica of other buildings in the area.
- (f) Development must not include garages or car access to the front elevation of the development where these are not characteristic of the area.
- (g) The removal of significant public domain features will only be considered if their retention in situ is not feasible and has been demonstrated in a Heritage Impact Statement.
- (h) Building services including air conditioning units, satellite dishes and aerials are not to be visible from the streetscape.
- (i) If significant public domain features are to be removed, they are to be replaced in one of the following ways:
  - (i) Detailed and made of materials to match the period and character of the street or park in which they are located; or
  - (ii) A contemporary interpretation of traditional elements.

## 8.5 LANDSCAPE CONSERVATION AREAS

Where a place or object is included in the National Heritage List, development and building approval will be required for major work under the Environmental Planning and Assessment Act 1979 (EP&A Act). Waverley Council is the consent authority, however referral to the Australian Heritage Council under the Environmental Protection and Biodiversity Act 2012 is required if the proposal is likely to negatively impact on the National Heritage values.

### Objective

- (a) Retain all aspects of Landscape Conservation Areas that contribute to the identified heritage significance of the area.

### Controls

- (a) New works in the vicinity of Landscape Conservation Areas and natural settings are to acknowledge the significant character, detail and context of the setting.
- (b) Any new works must consider the visual and physical impact upon the setting.
- (c) Any new work should avoid the removal of fabric whether plant material, manmade feature or natural formation and any works likely to cause long or short term impact upon the setting e.g. change in ground water flow, reflected light, illumination of natural planting and stability of natural or manmade features.
- (d) The removal of significant public domain features will only be considered if their retention in situ is not feasible and has been demonstrated in a Heritage Impact Statement.
- (e) If significant public domain features are to be removed, they are to be replaced in one of the following ways:
  - (i) Detailed and made of materials to match the period and character of the street or park in which they are located; or
  - (ii) A contemporary interpretation of traditional elements.

## 8.6 CHARACTER AND STREETScape

### Objectives

- (a) To reinforce the existing street character, through appropriate dwelling facades, building setbacks, fence and landscaping.
- (b) To ensure that alterations and additions to the external appearance of heritage items and contributory buildings respect the contributory features and characteristics of the existing building and streetscape.
- (c) To allow infill development that respects and complements the existing character of the area.
- (d) To reinforce existing views along streets and from the public domain.

### Controls

#### 8.6.1 All Development

- (a) A Context and Streetscape Analysis is to be provided that identifies common elements and features of the area including:
  - i. Topography and landscape;
  - ii. Views to and from the site;
  - iii. Significant subdivision patterns, layout, front and side setbacks;
  - iv. The type, siting, form, height, bulk, roofscape, scale, materials and details of adjoining or nearby contributory buildings;
  - v. The interface between the public domain and building alignments and property boundaries; and
  - vi. Colour schemes that have a hue and tonal relationship with traditional colour schemes.
- (b) Development should identify and respect the contributory features and characteristics of the item or the conservation area and incorporate these features into the design.
- (c) The established landscape character of the locality including the height of canopy and density of landscaping should be retained.
- (d) Development near a heritage item should respect the visual curtilage of the item.

#### 8.6.2 Heritage Items and Contributory Buildings

- (a) Additions should be located to the rear to minimise the impact from the street (refer to Figure 7).
- (b) Where the building form, detailing or use of individual buildings of historic character have been inappropriately altered and changed, any application to up-grade or re-use the buildings must clearly demonstrate that the architectural and streetscape value of the building will be enhanced by the proposal.



Figure 7 Sympathetic additions located to the rear

### 8.6.3 Infill Development

- (a) New development and alterations and additions to existing dwellings should be compatible and consistent with development both in the immediate vicinity and in the overall context of the street.
- (b) Contemporary design is acceptable in a conservation area where it is sympathetic to, and respects the context of the conservation area and any heritage item in the vicinity (refer to Figure 8).
- (c) New buildings adjacent to buildings of historic character or heritage items should be secondary in prominence to the existing streetscape fabric and draw on the predominant pattern of the existing streetscape.
- (d) Where properties have side street or rear lane frontages, alterations and additions reinforce the desirable side or rear streetscape.
- (e) Appropriate landscape species and plantings are used to reinforce and frame existing vistas, particularly in the typical north-south street corridors.



Figure 8 Sympathetic infill development

## 8.7 SITING

### Objectives

- (a) To ensure that the existing heritage character of the streetscape including setbacks, siting and landscaping is maintained.
- (b) To maintain the general pattern of setbacks within a street.
- (c) To ensure that adequate curtilage and landscape setting is provided.
- (d) To ensure that the siting of alterations and additions to existing and new buildings retains the integrity of the heritage item, its setting, and the conservation area.

### Controls

---

#### 8.7.1 All Development

- (a) Development should conform to the predominant front setbacks in the streetscape.
- (b) Front and rear setbacks should ensure the retention of the existing landscape character of the heritage item or conservation area.
- (c) Any significant historical pattern of subdivision and lot sizes is to be retained.
- (d) Development should respect or utilise the topography and existing vegetation of the land such as rock outcrops and mature trees.
- (e) Building setbacks, terraces, balconies and rooflines are to be consistent within the defined street corridor and provide uniformity to a group of attached dwellings, or mirror an attached semi.

---

#### 8.7.2 Heritage Items and Contributory Buildings

- (a) Extensions should be kept to the rear of the site to minimise the impact upon the streetscape.
- (b) If there is insufficient space for a rear extension, side extensions should be setback as far as possible from the street.
- (c) Subdivision or site amalgamation involving heritage items or contributory buildings should not compromise the setting or curtilage of buildings on or adjoining the site.
- (d) Construction, demolition or modification should not adversely affect the existing setting of the item or area.

## 8.8 SCALE AND PROPORTION

### Objectives

- (a) To ensure that alterations and additions to heritage item and contributory building are consistent with the scale and proportion of the item and/or streetscape.
- (b) To encourage infill development that recognises the predominant scale and proportion of the setting and responds sympathetically.
- (c) To promote development that is respectful of the scale of the surrounding buildings and area.

### Controls

#### 8.8.1 Heritage Items and Contributory Buildings

- (a) Alterations and additions should not visually dominate, compete with or conceal the original scale and proportion of the heritage item, contributory building or conservation area.
- (b) Alterations and additions should respect the proportions of major elements including doors, windows, roof forms and verandahs (refer to Figures 9-11).

#### 8.8.2 Infill Development

- (a) Infill development should be cohesive in scale, proportion and finish to the surrounding streetscape and buildings (refer to Figure 12).
- (b) Infill development should maintain and enhance the skyline profiles of established settings.
- (c) Where the scale of the roof is much larger than that of adjacent buildings, the roof should be broken up into smaller elements to reduce bulk.
- (d) Setbacks should be provided to upper levels.

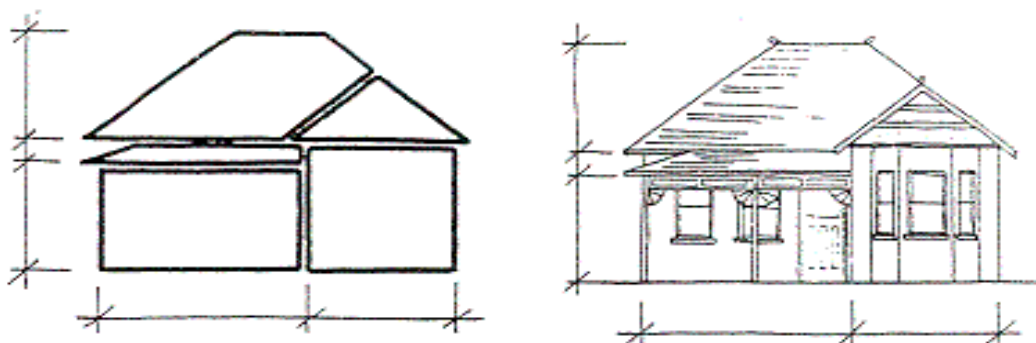


Figure 9 Consideration of scale and proportion



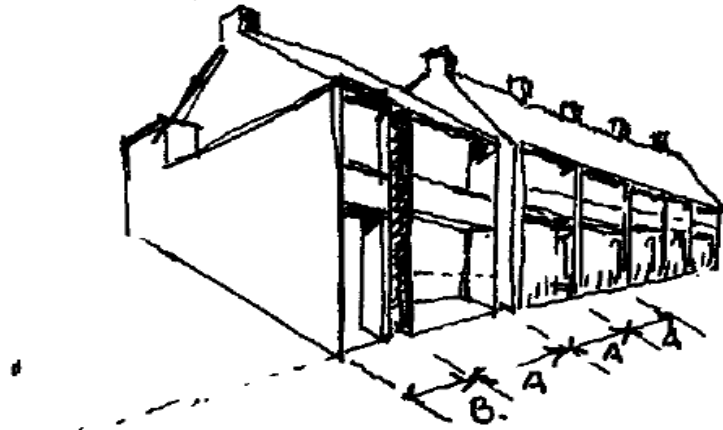


Figure 10 Consideration of scale and proportion within a row of terrace houses

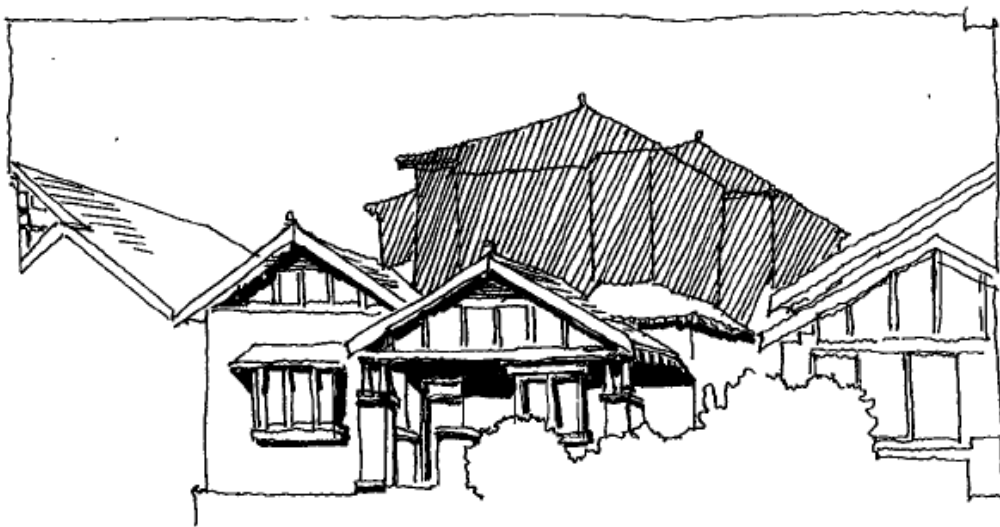


Figure 11 Unsympathetic additions in relationship to the scale of the original dwelling



Figure 12 Sympathetic infill development

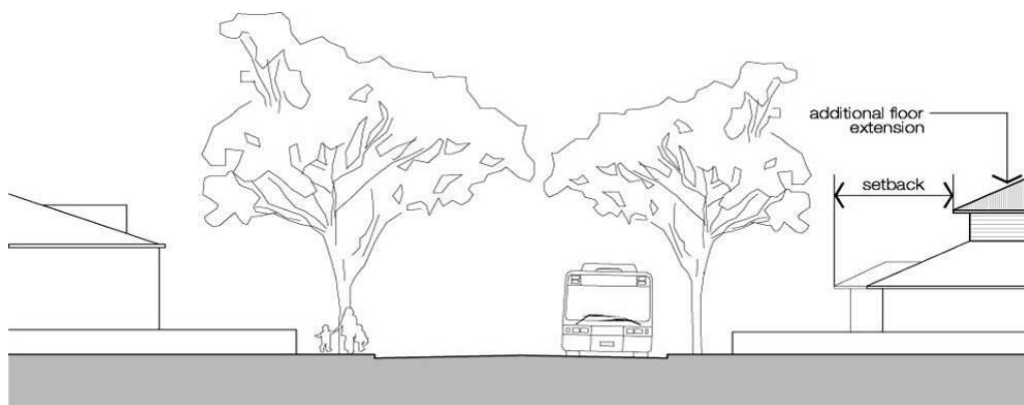
## 8.9 ARCHITECTURAL STYLE

### Objectives

- (a) To reinforce the various established architectural styles of dwellings through sensitive alterations and additions and appropriate new developments.
- (b) To emphasise balance and symmetry in alterations and additions to detached, semi-detached and attached dwellings.
- (c) To reinforce the existing pitched roofscape as the desired character of conservation areas and promote consistency in roofing materials.

### Controls

- (a) New development is to be sympathetic to the established architectural style in the vicinity and preserve the area's character.
- (b) Where the existing building or structure contributes to a historical or coherent theme of the street, re-use or refurbishment of the existing building is encouraged.
- (c) Alterations and additions to existing dwellings must incorporate appropriate or compatible architectural vocabulary, consistent with the period of the building's original development.
- (d) Where a building sits in a row with similar architectural style and details (such as gable, roofscape, entrance, terrace roof, chimney, windows, door, fences), the bulk and rhythm of these details are to be maintained.
- (e) Where terrace (attached) and semi-detached dwellings have a small front setback, their façade detail and building elements, such as doors, windows, balustrades, mouldings or tiles are to be sensitively integrated with the streetscape character.
- (f) Flat roofs are to be avoided where they detract from the established roof character of the locality. Where they are visible from the street, roofing materials and details shall be compatible with the established streetscape character.



**Figure 13** An example of alterations and additions which are sensitively undertaken. First floor additions are set back in order to minimise the impact upon the street character.

## 8.10 MATERIALS AND COLOUR

### Objectives

- (a) To ensure that the selection of materials and colours is harmonious with the item or conservation area.
- (b) To ensure infill development considers the materials and colours characteristic of the conservation area.
- (c) To ensure that detailing and decoration is provided in consistent materials, finishes and colours to listed heritage items and identified conservation areas (refer to *Annexure B8-1*).

### Controls

#### 8.10.1 Heritage Items and Contributory Buildings

- (a) Council may require a proposed colour palette to be submitted with the development application.
- (b) Original construction and in particular original finishes are to be maintained where possible.
- (c) Changes to materials on elevations visible from the public domain are discouraged.
- (d) Alterations and additions should use materials similar to or compatible with the original material used.
- (e) The selection of materials and colours is to be consistent with those used in the item or conservation area.
- (f) Colours for alterations and additions should be consistent or harmonious with existing building to help integrate new and old.
- (g) Previously unpainted surfaces should not be painted. Painting of original stone or face brickwork causes fretting and eventually substantial damage as it traps moisture inside. Similarly, clear sealer such as silicone should be avoided.
- (h) Original face brickwork and stonework is not to be rendered.
- (i) Bricks should match the existing brick and mortar colours as well as the type of joint and brick laying pattern.
- (j) New building work constructed of timber should match the existing building elements made of timber (e.g. frames, weatherboarding, fascias, brackets, columns, friezes, etc).
- (k) Cast iron or wrought iron elements, should be reinstated where possible.

#### 8.10.2 Infill Development

- (a) Infill buildings should recognise characteristics materials, textures and colours used locally and in adjacent buildings.
- (b) Materials and colours of surrounding buildings need not be simply copied but used as a point of reference.
- (c) Modern materials can be used if their proportions and details are harmonious within the surrounding historic context.

## 8.11 ROOFS AND CHIMNEYS

### Objective

- (a) To retain and maintain the characteristic roof forms, finishes and chimneys of heritage items and conservation areas.
- (b) To ensure new roof profiles are consistent with the established skyline profiles of the conservation area.

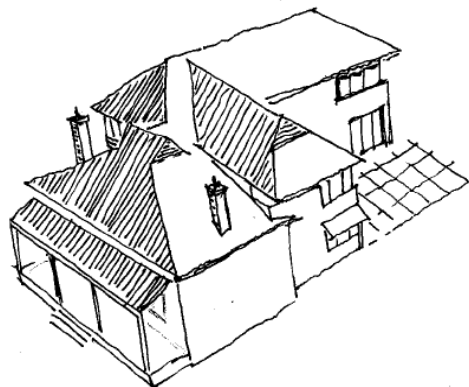
### Controls

#### 8.11.1 Heritage Items and Contributory Items

- (a) Skyline profiles of original roofs and chimneys should be retained where possible.
- (b) Original chimneys are to be retained.
- (c) Where chimneys are paired across party walls, treatment of finishes and detailing is to be consistent between properties.
- (d) Substitution of finishes and removal of details including chimneys is only permitted where Council approves a cohesive replacement finish or detail.
- (e) Attic rooms are to be wholly within existing roof forms which retain the streetscape appearance of the existing building.
- (f) Roof extensions are to match the existing roof in form, pitch and eaves and be in proportion with the existing building.
- (g) The use of modern roofing materials is discouraged as they can significantly alter the character of the building.
- (h) New tiles or slates should match the existing tiles/slates as closely as possible and concrete tiles are not considered a suitable replacement material.

#### 8.11.2 Infill Development

- (a) New roof profiles are to be secondary to the established skyline profiles in the Heritage Conservation Area and are to enhance the established character of the existing skyline (refer to Figure 13).



**Figure 14** New roof forms are to be secondary to the established skyline profile

## 8.12 VERANDAHS AND BALCONIES

### Objectives

- (a) To ensure the retention and reinstatement of early verandahs and balcony forms.
- (b) To ensure that alterations and additions do not detract from original balconies and verandahs.

### Controls

#### 8.12.1 Heritage Items and Contributory Buildings

- (a) All original verandahs and balconies should be retained and restored (refer to Figure 15).
- (b) Infilling or enclosure of verandahs and balconies is not supported.
- (c) Additional verandahs should not compete with an original verandah or balcony.



Figure 15 Original verandahs should be retained

## 8.13 GARAGES, PARKING AND SITE ACCESS

### Objectives

- (a) To retain the heritage character of the streetscape.
- (b) To promote the retention of original front facades, fences, masonry and landscaping that may otherwise be removed for parking.

### Controls

#### 8.13.1 All Development

- (a) Where car access is available to the rear or side of a property, parking is not permitted within the property frontage.
- (b) Where rear lane access to a property exists or is provided, garages and driveways are to be located at the rear.
- (c) No part of an existing building is to be demolished or altered in order to accommodate a carport, garage or car space within the front or side setbacks or facades.
- (d) Original fences are not to be removed to create car access from the main street frontage unless there is sufficient space to access a side driveway.
- (e) Car spaces are not supported between a building and the front boundary. Council may consider an unroofed parking space in exceptional circumstances where it is shown that the space does not dominate the setting of the house.
- (f) The form, size, detailing and materials of any new structure are to complement the heritage item, contributory building, or character area.
- (g) Where driveways are permitted, pavement materials should reflect the traditional character of the area. Large areas of continuous concrete or asphalt are not to be used, however these materials may be used in smaller areas if designed in appropriate ways. Preferred materials include dry laid paving. Stenciled concrete is not permitted.

#### 8.13.2 Heritage Items and Contributory Buildings

- (a) Development to Heritage Items and Contributory Buildings must not include garages or driveways to the front of the property.

#### 8.13.3 Infill Development

- (a) Infill Development must not include garages or driveways to the front of the property where these are not characteristic of the area.
- (b) Where no rear lane access is provided and it is consistent with the predominant character of the area, garages should be either setback behind the line of the dwelling frontage, or incorporated within the building design (for new dwellings).
- (c) Where the streetscape is dominated by garages located up to the front boundary, garages may be allowed in front of the dwelling. Driveway width shall be minimised to maximise on street parking availability and landscaping used to unify the garage and dwelling with the landform.

## 8.14 GARDEN ELEMENTS

### Objective

- (a) To ensure that the landscape settings and elements of heritage items or buildings within a conservation area are retained or reinstated.
- (b) To promote the retention of original soft and hard landscaping to maintain the character of the area.
- (c) To promote the retention of coursed local sandstone retaining walls that are characteristic of Waverley's heritage.

### Controls

#### 8.14.1 Heritage Items and Contributory Buildings

- (a) Original and contributing elements of hard and soft landscaping are to be retained on heritage listed sites and where occurring in Conservation Areas.
- (b) Where a site contains existing coursed local sandstone retaining walls, the walls are to be retained and incorporated into the overall design.
- (c) High walls or fences and unsympathetic garden treatment (e.g. rockeries, dense plantings that are out of character) are discouraged.
- (d) New hard and soft landscaping is to be provided with regard to the:
  - (i) Stability of existing significant fabric;
  - (ii) Retention and enhancement of original hard and soft landscaping; and
  - (iii) Character of the site and/or Conservation Area.

## 8.15 BUILDING FACADES

### Objective

- (a) To retain the existing façades of original heritage items, contributory buildings or buildings consistent with the character of the area.

### Controls

---

#### 8.15.1 Heritage Items and Contributory Buildings

- (a) Where a building façade provides the core character detail and aesthetic qualities of an item the extent of a cohesive alteration and addition may extend to removal of other areas of the listed structure provided the façade remains in conjunction with a full structural bay or room depth and there remains a cohesive interface of new and existing works.
- (b) Alteration or removal of original facades which are of heritage significance is not supported.
- (c) Proposed works are to be sympathetic to and not detract from the style and character of the building.



## 8.16 DETAILING

### Objectives

- (a) To encourage the retention and maintenance of original detailing to preserve the character and significance of the area or item.
- (b) To ensure alterations and additions have a level of detail that is appropriate to the architectural character and style of the heritage item or conservation area.
- (c) To ensure infill development has regard to the architectural character and style of the conservation area.
- (d) To promote the retention of historic detailing styles and practices.

### Controls

#### 8.16.1 All Development

- (a) Landscape details such as fences, garden walls and planting treatment which contribute to the area should be retained where possible.
- (b) New windows should match the existing in size and detail, including the existing sill details, window heads, and stained or patterned glass type. Window should not be enlarged or altered.

#### 8.16.2 Heritage Items and Contributory Buildings

- (a) Development should be designed to enhance original detailing of buildings.
- (b) Original details should be retained and repaired where possible.
- (c) Where original details have been removed or replaced with modern materials, consideration should be given to reinstating original features.
- (d) Decorative elements should not be introduced on heritage items and contributory buildings unless documentation or physical evidence indicates the elements previously existed.
- (e) Alterations and additions should adopt a similar character, which uses external finishes, colours, and textures that complement the heritage fabric, rather than mimic inappropriate decoration or detailing (refer to Figure 16).

#### 8.16.3 Infill Development

- (a) Modern details should defer to, and be cohesive with, traditional details that contribute to the character of the area.



Figure 16 Sympathetic detailing of additions.

## 8.17 FENCING AND GATES

### Objectives

- (a) To ensure new fencing is consistent with, and does not detract from, the heritage item or streetscape.
- (b) To retain, repair and reconstruct original fencing.
- (c) To ensure fencing makes a positive contribution to the character and quality of the street.

### Controls

#### 8.17.1 Heritage Items and Contributory Buildings

- (a) Where original fences remain on listed items or within Conservation Areas these are to be retained and enhanced by appropriate maintenance and sympathetic landscaping.
- (b) Planting and maintenance of existing planting is to avoid tree or plant growth that damages existing fences or gates.
- (c) Fences and boundary walls employing masonry (principally stone or face brick) construction are not to be rendered, painted or coated with other materials unless the finish is known to be a detail of the original construction.
- (d) Front fences should not obscure building facades.
- (e) New fence heights and form should be appropriate to the character of the heritage item or to the conservation area.
- (f) Where an original fence has been lost, new fencing should match the original style.
- (g) Sandstone fencing and foundations should be retained and sympathetically incorporated into any new additions or alterations. Restoration/repair of slate/stone must be carried out by specialists.
- (h) Low and transparent front fences in front yards are desirable, especially where setbacks are minimal.
- (i) Front fences should be of a low or transparent style and where masonry is used it should be no higher than 600mm, while transparent fences may not exceed 1200mm in height.
- (j) Rear fences should be between 1.8m and 2m in height.

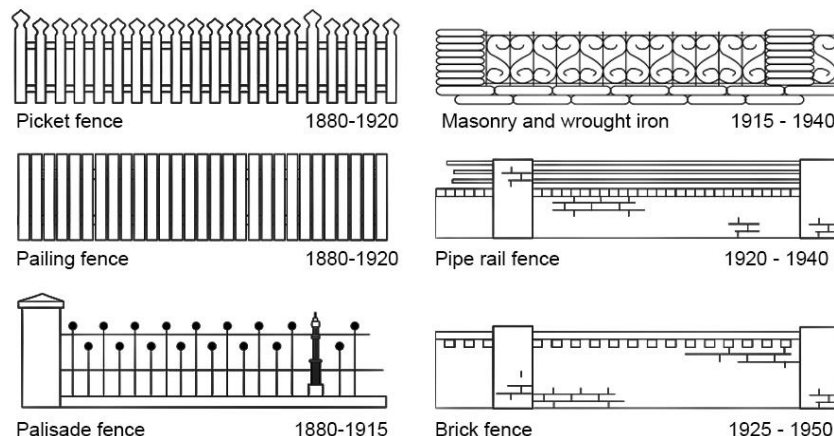


Figure 17 Examples of period fences



**Figure 18** Low fences are desirable, especially where setbacks are minimal.

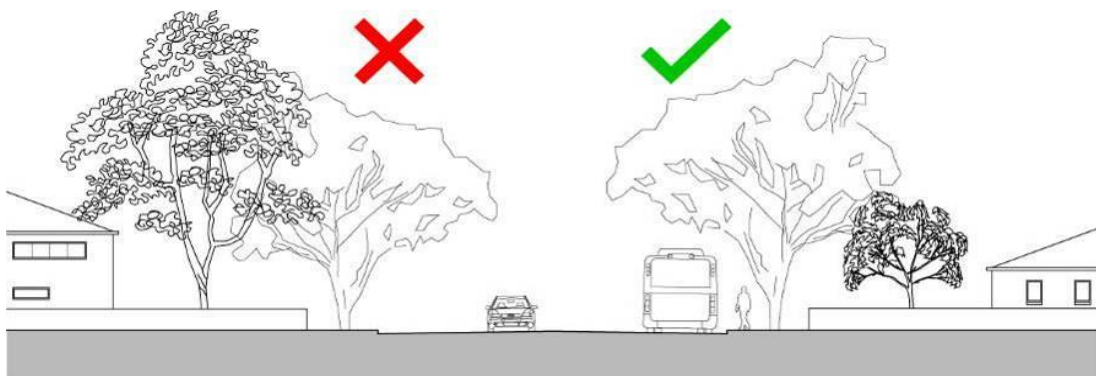
## 8.18 LANDSCAPING

### Objectives

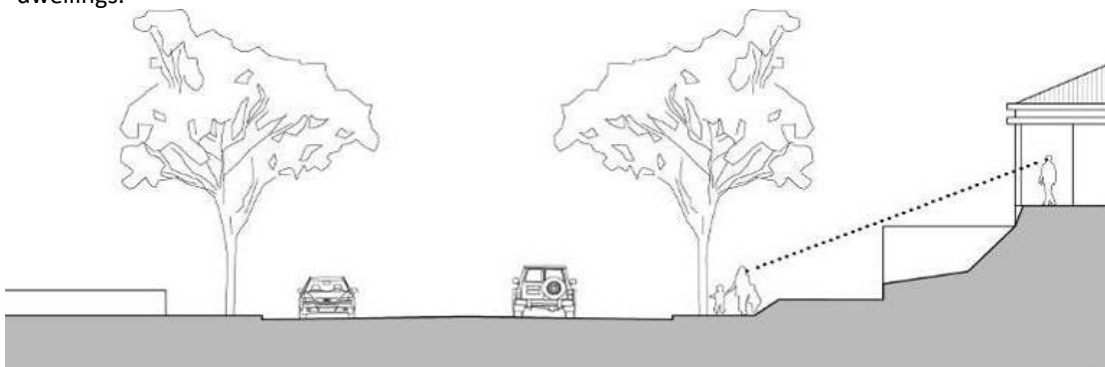
- (a) To conserve the existing inner residential street landscape character and view corridors which have been established by the colonnades and canopy of existing street tree planting.
- (b) To establish soft landscaping at the front setback compatible with the style and character of the area.

### Controls

- (a) Unless it is the predominant character, overly dense landscaping or large trees are not desirable in the front setback as they darken the street corridor and undermine the character of the existing street tree plantings (refer to Figure 19).
- (b) On steeply sloping or split level sites landscaping is to be planted so as to allow for a visual connection between the building facades and the street (refer to Figure 20).
- (c) Soft landscaping is used to reinforce important character elements in the front of dwellings, especially detached dwellings and larger sites.



**Figure 19** Where mature street trees exist, avoid high and over dense landscaping in the front of dwellings.



**Figure 20** A visual connection to the street is important to cultivate surveillance and is in keeping with the established character.

## 8.19 COMMERCIAL PROPERTIES

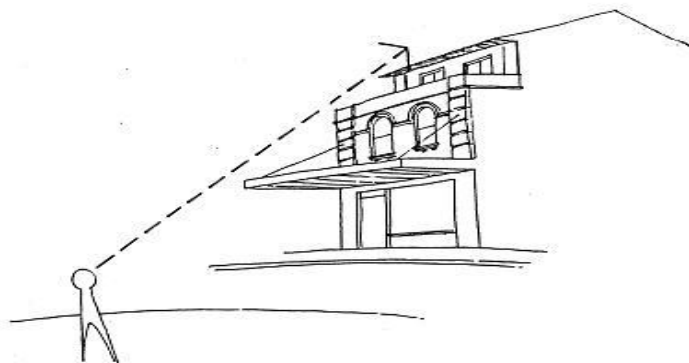
### Objective

- (a) To ensure that the original characteristics of traditional neighbourhood retail buildings are retained and enhanced.
- (b) To encourage the retention of distinctive settings of grouped building frontages aligned to the street.
- (c) To promote the retention of distinctive detailing on commercial properties.
- (d) To retain original parapet continuity and detailing.
- (e) To retain architectural features and detailing that characterise the period of development.

### Controls

#### 8.19.1 All Development

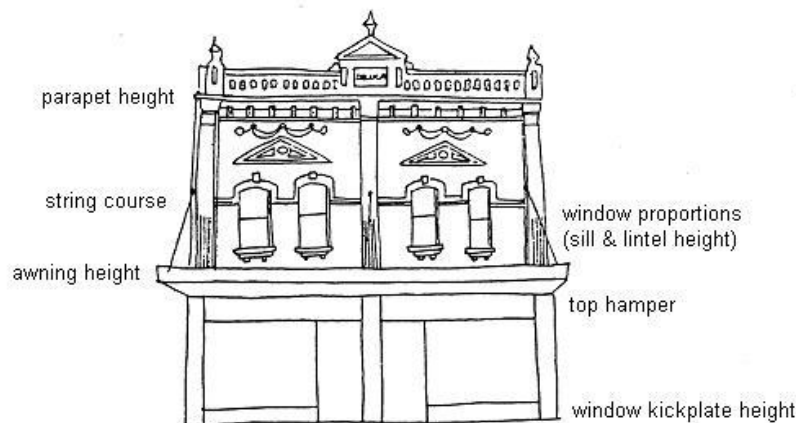
- (a) Generally, the facade at street alignment shall comprise a canopied shop front at ground level, and first floor facade above the awning.
- (b) The height of the building at the facade shall take into consideration existing parapets and other facade details of established surrounding development.
- (c) Additional floors should be setback from the street alignment to ensure a two storey elevation to the facade is maintained where appropriate (refer to Figure 21).
- (d) Consideration will be given to a variation of the established alignment in the case of a comprehensive development incorporating a pedestrian open space function.
- (e) Developments on corner sites should be designed to accentuate the corner, and provide the transition between one streetscape and the next. Existing corner splays shall be retained.
- (f) Signage shall be restricted to under awning shop fronts, awning fascias and as suspended under awning signs.
- (g) Signage above the awnings shall be limited to appropriate areas allocated for such a purpose in the original facade design (parapets for example).
- (h) Flush mounted, or projecting wall signs shall not be permitted above the awning. Council will give consideration to the architectural qualities of the building when addressing the suitability of the proposed sign.
- (i) Pitched or domed awnings of glass or canvas construction shall not be permitted where they interrupt a run of traditional awnings.



**Figure 21** Additional floors should be setback from the street alignment

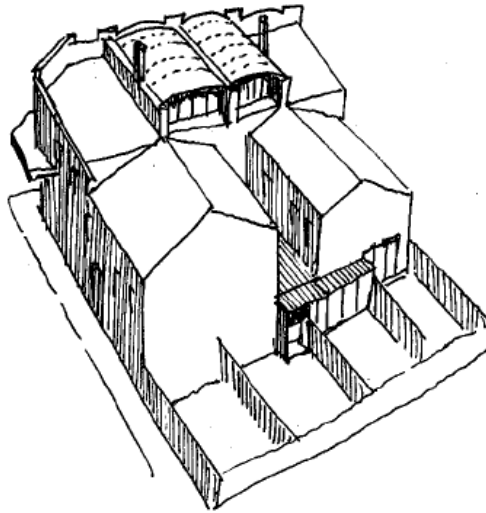
### 9.19.2 Heritage Items and Contributory Buildings

- (a) Details of earlier shop front features should be retained.
- (b) The maintenance and restoration of detailing to commercial/retail groups is encouraged (refer to Figure 22).
- (c) Horizontal proportions should be considered both in new development, and in the redevelopment of old facades. Consistency should be achieved through:
  - (i) Parapet height;
  - (ii) String course both at parapet level, and to the remainder of the facade;
  - (iii) Window proportions (sill and lintel height);
  - (iv) Awning height and continuity; and
  - (v) Top hamper proportions and window kick plate height.



**Figure 22** Overall consistent design of elements

- (d) Where shopfront groups are listed as heritage items the following issues are to be considered:
  - (i) The extent and quality of conservation and restoration of street frontages;
  - (ii) The interface of new and existing works; and
  - (iii) The impact of new works on the existing fabric, streetscape and overall setting.
- (e) Where it is proposed to retain the street facade and construct new works to the remainder of the site, assessment will be based upon the above the impact of skyline profiles on the retained façade the setting and the cohesion of the works (refer to Figure 23).
- (f) Existing shop fronts should not be bricked up or replaced by roller shutters.
- (g) Existing box section awnings, either cantilevered, or suspended by tie rods, should be retained.
- (h) New awnings should match the form of adjacent awnings and maintain the same alignment, to ensure unity in streetscape details.
- (i) Reinstatement of balconies and verandahs to street frontages is supported.
- (j) Alterations to individual shop facades above awning level will not be permitted where that facade is part of a homogeneous or symmetrical group of facades.
- (k) A row of shops which are homogeneous or symmetrical in style should adopt a uniform tonal distribution over the facade, without limiting the individual expression of colour on each shop.



**Figure 23** Rear extensions to commercial properties

---

### 8.19.3 Infill Development

- (a) New development should conform to the established street front building alignment for the extent of its height.
- (b) New under awning shop fronts should be simply detailed with large areas of glazing and narrow mullions/framing.
- (c) The height of new development at the street alignment should not exceed the height of existing buildings.

## B9 SAFETY

The aim of these controls is to ensure that the way in which the site and the buildings within the site are laid out, enhance security and feelings of safety and clearly delineate between private and public space.

This Part should be read in conjunction with NSW Government's Crime Prevention and the Assessment of Development Applications Guidelines under Section 4.15 of the *Environmental Planning and Assessment Act 1979*.

The preparation of a Crime Prevention Through Environmental Design (CPTED) assessment is to be prepared in accordance with the *Waverley Development Application Guide*.

### 9.1 BUILT FORM

#### Objectives

- (a) To provide for a safe environment for residents, visitors and workers and minimise the opportunities for criminal and anti-social behaviour.
- (b) To encourage the design and management of the built environment to reduce the opportunity for crime.

#### Controls

- (a) Maximise casual surveillance by orientating buildings towards the street.
- (b) Active spaces including windows of habitable rooms within the buildings are to be located to maximise casual surveillance of public spaces such as streets, laneways, parking areas and communal areas such as play areas, swimming pools, gardens and the like.
- (c) The design of building details including the provision of fencing, drainpipes and landscaping is to be such that illegitimate access is not facilitated through the creation of footholds, concealment and the like.
- (d) Minimise blind corners, recesses and other external areas which have the potential for concealment.
- (e) Pathways and entries providing access to, around and within the site should be designed to ensure good visibility for and of the user.
- (f) Building entries and mailbox entries are to be clearly visible, easily identifiable from the street and unobstructed.
- (g) Pedestrian routes to and from car parking spaces including to lift lobbies are to be as direct as possible with clear sightlines.
- (h) All entrance and exits, service areas must be clearly identifiable after dark by appropriate lighting.
- (i) All lighting on the site should be designed so it doesn't produce areas of glare and shadow or create a nuisance for neighbours.
- (j) Details of all lighting for public areas must be submitted with a development application for multi-residential development i.e. details of location, type and intensity.



- (k) Fencing which is used to delineate private space is to be used in a way which enhances safety by maximising opportunities for casual surveillance between the dwellings and the street frontage.
- (l) Materials should minimise opportunities for vandalism.
- (m) Flat or porous finishes should be avoided in areas where graffiti is likely to be a problem. Use non-porous material such as glazed ceramics or treated masonry products.
- (n) Where large blank walls are unavoidable, consider the use of a “green screen” i.e. planting vegetation in front of the wall or using vegetation to cover the wall itself. Alternatively use vandal resistant paint or artwork to reduce opportunities for graffiti or articulate or modulate the wall.
- (o) Ensure individual dwellings are equipped with security devices.
- (p) Where public spaces of larger developments could result in the gathering of groups of people, the development may be required to provide CCTV facilities to monitor those areas.

## B10 PUBLIC ART

This part applies to new developments and major alterations and additions and is to be read in conjunction with the *Waverley Council Public Art Policy* and the *Waverley Public Art in the Private Domain Guidelines*.

### 10.1 PUBLIC ART IN THE PRIVATE DOMAIN

#### Objectives

- (a) To ensure new public spaces include high quality, diverse and creative public art and visual art.
- (b) To encourage developments to contribute to the ongoing development of public art and visual art within Waverley.
- (c) To increase public art in Waverley for greater community cohesion and understanding of the history, culture and place

#### Controls

- (a) Developments located within an E1, E2 or MU1 zone, with a construction value exceeding \$10 million are required to integrate a public artwork into the development to a minimum value of 1% of the construction costs (excluding administration and associated costs).
- (b) Applicants are encouraged to clarify the value and type of public art during the Pre-Development Application process via the preparation of a Public Art Plan – to be submitted as part of the DA.
- (c) Developments are to incorporate public art in highly visible areas such as public plazas, through site links, and external walls.
- (d) Public art is to be integrated into the architectural integrity of a development.
- (e) All privately commissioned public art must be undertaken in accordance with the *Waverley Public Art in the Private Domain Guidelines*.
- (f) Murals do not require development consent, however must be undertaken in accordance with the *Waverley Public Art in the Private Domain Guidelines*.
- (g) Murals that contain marketing or advertising material, or the like, will be treated as signage, and must seek development consent and comply with the provisions of *Part B14 Advertising and Signage*.
- (h) Artworks on heritage items or within heritage conservation areas must also comply with the provisions of *Part B8 Heritage*.

## B11 DESIGN EXCELLENCE

Applicants are to refer to the relevant design excellence policies as produced by the Government Architect New South Wales.

### 11.1 DESIGN

#### Objectives

- (a) To ensure development contributes to the architectural and overall urban design quality of Waverley.
- (b) To encourage variety in architectural design and character across large developments.
- (c) To identify the key components of good urban design.
- (d) To increase the value of site and context analysis and promote site specific design responses.

#### Controls

- (a) Development is to achieve a high standard of architectural design, materials and detailing appropriate to the building type and location.
- (b) The form and external appearance of development is to improve the quality and amenity of the public domain.
- (c) Development is to consider and retain view corridors. Development will not be supported where detrimental impacts upon views and vistas is imposed, particularly those views from the public domain.
- (d) Development must not have a detrimental effect upon the amenity of public plazas and public open spaces.
- (e) Development must consider the following:
  - (i) The suitability of the land for development;
  - (ii) Existing and proposed uses and use mix;
  - (iii) Heritage issues and streetscape constraints;
  - (iv) The relationship of the development to other development (existing or proposed) on the same site or on neighbouring sites in terms of separation, setbacks, amenity, and urban form;
  - (v) Bulk, massing and modulation of buildings;
  - (vi) Street frontage heights;
  - (vii) Environmental impacts such as sustainable design, overshadowing, wind and reflectivity;
  - (viii) The achievement of the principles of ecologically sustainable development;
  - (ix) Pedestrian, cycle, vehicular and service access, circulation requirements; and
  - (x) The impact on, and any proposed improvements to, the public domain.

## 11.2 CONTEXT ANALYSIS

### Objectives

- (a) To increase the value of site and context analysis and promote site specific design responses.
- (b) To ensure that development demonstrates an understanding of an appropriate response to the specific conditions of both the site and surrounds.
- (c) To identify the key contextual features and characteristics of the surrounding urban form to which the design should respond.
- (d) To ensure that the opportunities and constraints of a site are fully considered and incorporated into the design proposal.

### Controls

#### 11.2.1 Context Analysis

- (a) A Context Analysis is to include an analysis of the urban form including but not limited to the following:
  - (i) Urban structure - The relationship between buildings, spaces, infrastructure and connections, landform, topography and natural features.
  - (ii) Urban grain - The subdivision pattern, the scale and configuration of streets and lots, and the rhythm of buildings and spaces.
  - (iii) Density and Mix - The amount of development and the range of uses in relation to the site's location and size; and its accessibility and proximity to other uses.
  - (iv) Height and massing - The scale, arrangement, volume and shape of buildings in relation to humans, other buildings, structures, spaces, skylines and views.
  - (v) Building type - The building footprint, its layout, circulation and access, and its functional relationship to adjoining spaces and buildings.
  - (vi) Façade and interface - The relationship and expression of the external faces of the building, its rhythm and pattern of openings, expression of entries, corners and roofscape, setbacks and boundary treatments.
  - (vii) Details and materials - The techniques, craftsmanship and detail of building components, and how the proposed selection of materials relate to the context through colour, pattern and treatment of materials including durability, sustainability and contextual fit.
  - (viii) Streetscape and landscape - The surrounding built and natural context, including street elevation, building typologies and their spatial and locational characteristics, treatment of street/boundary interfaces, microclimate, ecology and biodiversity. Relate the analysis to how the proposed development contributes to the streetscape and landscape of the area.
  - (ix) Social and economic fabric - Non-physical aspects of urban form including the productive capacity and economy of the community, cultural and social factors such as health and wellbeing, and community interaction.

## B12 SUBDIVISION

These subdivision provisions supplement the WLEP provisions on minimum lot size. The provisions apply to Torrens Title subdivision, not Strata Title Subdivision.

The WLEP permits subdivision with consent, however applicants should also refer to *State Environmental Planning Policy (Exempt & Complying Development) 2008* which enables some forms of subdivision as exempt or complying development.

### Objectives

- (a) To maintain the established character of low density neighbourhoods occupied by dwelling houses, semi-detached dwellings, attached dual occupancies or a mixture of these housing types.
- (b) To ensure that subdivision or amalgamation respects the predominant development pattern of the locality.
- (c) To ensure that subdivision or amalgamation results in allotments that have adequate width and configuration to deliver suitable building design and to maintain the amenity of the neighbouring properties.
- (d) To prevent the fragmentation of land that would prevent the delivery of permitted uses on the lot.
- (e) To ensure that subdivision results in lot sizes that protect natural or cultural features including heritage items, protected ecological communities or species, and retain special features such as trees and views.
- (f) To avoid increasing the community's exposure to coastal hazards by minimising the number of residents living within areas that are at risk from coastal hazards.
- (g) To ensure that subdivision and amalgamation result in lots that can achieve compliance with all other relevant DCP controls.
- (h) To ensure that the creation of new lots does not result in a reduction of pedestrian or vehicular connectivity within the existing street network and provides a safe network.
- (i) To minimise any likely impact of subsequent development on the amenity of neighbouring properties.
- (j) To ensure that street addresses comply with the *NSW Address Policy and User Manual 2021*.

### Controls

- (a) Minimum lot sizes are contained in WLEP.
- (b) Where a proposed development involves the creation of a new lot, or number of new lots, capable of accommodating new buildings, the development application should be accompanied by at least a conceptual plan of the new building(s).
- (c) Applications must demonstrate that the following has been considered:
  - (i) Site topography and other natural and physical features;
  - (ii) Existing services and easements, or the need for new easements;
  - (iii) Vehicle access;
  - (iv) Any land dedications required (e.g. road widening);
  - (v) Existing vegetation;
  - (vi) Potential flood affectation and stormwater management requirements;
  - (vii) Existing buildings or structures; and

- (viii) Heritage Items, Conservation Areas and adjoining Heritage Items.
- (d) Any resulting lots must have characteristics similar to the prevailing subdivision pattern of lots fronting the same street, in terms of area, dimensions and orientation.
- (e) All resulting lots must have at least one frontage to the street, and adequate vehicle and pedestrian access.
- (f) Tree removal to permit vehicle access to a new subdivision is not supported.
- (g) Applications must demonstrate that any resulting allotments can facilitate development as per the zoning and controls on the land. This includes setbacks and open space provisions.
- (h) Subdivision or amalgamation must not result in the isolation of lots or reduce the development potential of adjoining land.
- (i) Applicants may be required to submit plans that clearly identify the future development potential of adjoining land to ensure its development potential will not be adversely impacted.
- (j) Subdivision or amalgamation must not compromise any significant features of the existing or adjoining sites including streetscape character, landscape features or trees.
- (k) Subdivision must not result in the creation of a new lot that contains significant site features that would render the land unable to be developed. For example the creation of allotments that are burdened by easements, flooding, or significant trees.
- (l) The isolation of parcels of land for the purpose of environmental protection only is not permitted. This land must be incorporated into any future development and maintained by the landowners.
- (m) Public lanes and public pedestrian passageways are not to be amalgamated with private land.
- (n) Where a rear lane is provided to adjoining land, the laneway configuration must be continued through any new allotments and existing access arrangements to adjoining land maintained.
- (o) Battle axe subdivision patterns will not be permitted within residential zones, unless it can be demonstrated that it is part of the prevailing subdivision pattern.
- (p) Battle axe subdivision patterns must result in one (1) or more allotments fronting the street and only one (1) allotment being serviced by an access handle.
- (q) Access corridors are to be located to ensure existing street trees are retained.
- (r) Access handles on battle axe blocks are to be a minimum of 3.5m in width and are to be landscaped in a manner complementary to the established character and streetscape of the area.
- (s) Where a proposed development will result in a change to, or introduction of a new street address, the proposed street addressing must be notated by the applicant on the DA and CC plans. This addressing must comply with the *NSW Address Policy and User Manual 2021*.

## B13 EXCAVATION

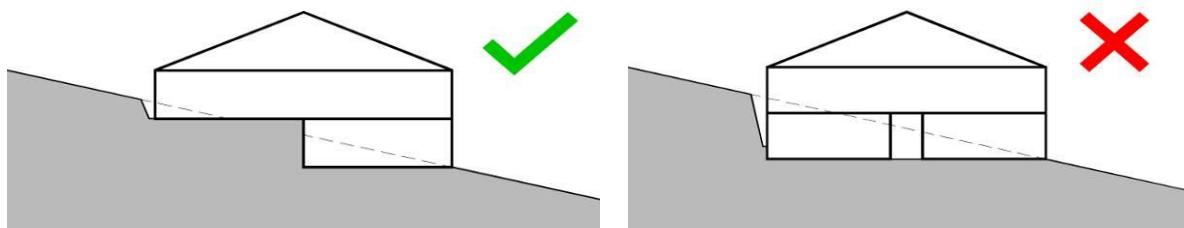
### Objectives

- (a) To set maximum acceptable volumes of excavation which achieve the following objectives.
- (b) To minimise the impact of excavation on the natural environment, neighbouring properties, and streetscape.
- (c) To ensure the physical environment is preserved and enhanced through minimal site disturbance and the geotechnical stability of landfill and excavations.
- (d) To minimise cut and fill on sloping sites.
- (e) To encourage good quality internal environments including natural light and ventilation.
- (f) To prevent use of subterranean spaces as habitable rooms.
- (g) To prevent development exceeding the maximum car parking controls.
- (h) To ensure excavation does not adversely impact land stabilisation, ground water flows and vegetation.
- (i) To minimise structural risks to adjoining structures.

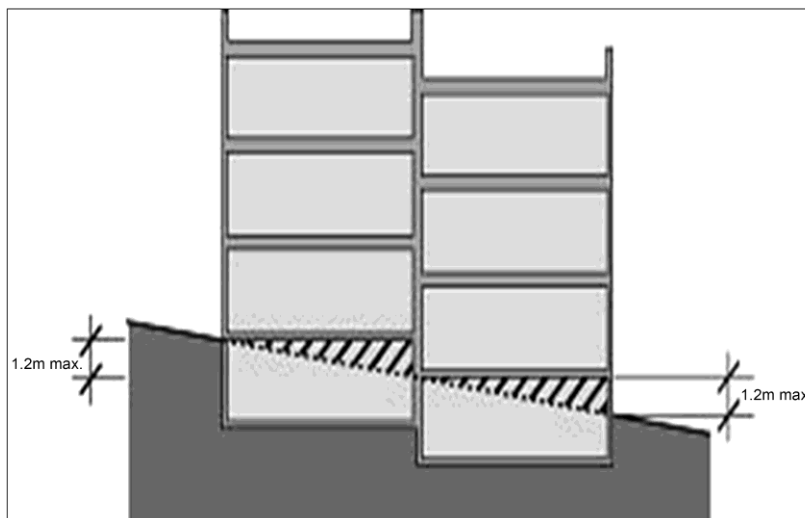
### Controls

- (a) The total volume of excavation permitted is to be no greater than the volume shown in Figures 26 and 27.
- (b) The maximum volume of excavation permitted for basement storage is 8 cubic metres per dwelling.
- (c) The maximum volume of excavation permitted for a plant room is the minimum required to meet Australian Standards, accommodate typical dimensions of equipment required and the associated circulation space to access the equipment for maintenance. DA plans should show the approximate location and size of equipment within the plant room.
- (d) Excavation should not add to the visual bulk and scale of the building.
- (e) Excavation should not result in the loss of naturally occurring sandstone.
- (f) Avoid cutting into the natural stone wall of a street.
- (g) Avoid and minimise excavation where possible.
- (h) Minimise the inclination of any resulting sloping landscaping.
- (i) Existing natural features including trees and sandstone walls should be retained and incorporated as landscape features on the site in order to maintain the natural character of the landscape.
- (j) Step retaining walls in response to the natural landform to avoid creating monolithic structures, particularly where visible from the neighbouring dwellings and the public domain.
- (k) For sites with significant slopes a split-level building design is to be used to minimise excavation and backfilling.
- (l) Fill is not to be used to raise the ground level.
- (m) Excavation for garaging within sandstone walls facing the street must be minimised to preserve as much of the original wall as possible.
- (n) Development should accommodate stormwater detention tanks and storage systems within the excavated area.
- (o) Excavation is not permitted within 900mm of side boundaries and shall only occur within the building footprint, except where access to a basement car park is required.

- (p) Basement car parking is to be located fully below natural ground level. Where this cannot be achieved due to topographic constraints, a maximum protrusion above ground of 1.2m is permissible (refer to Figure 25).
- (q) Where excavation is proposed for development which is subject to Part C2 of this DCP, it is not to occur within a 1.5m setback from side boundaries and shall only occur within the building footprint except where access to a basement car park is required. Excavation will need to be setback greater where required to comply with Part C2, 2.3.2 Side and Rear Setbacks control (d).
- (r) All below-ground structures that are located below the groundwater table are to be fully tanked. These types of structures must not collect and dispose of subsoil/seepage to kerb and gutter.



**Figure 24** Habitable rooms are to have ample openings to an external wall for air and light.



**Figure 25** Basement parking level on sloping sites



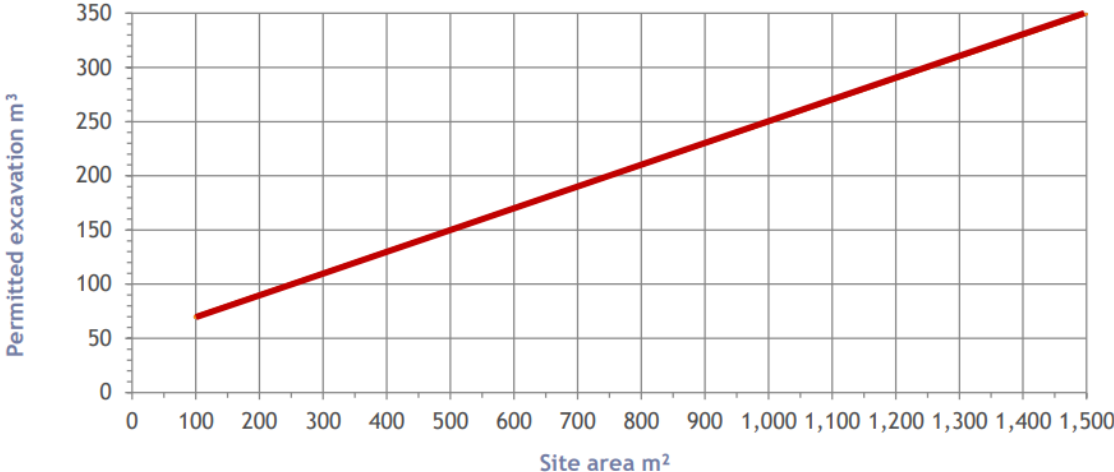


Figure 26 Maximum volume of excavation for a dwelling house, attached dwelling, dual occupancy development or semi-detached dwelling

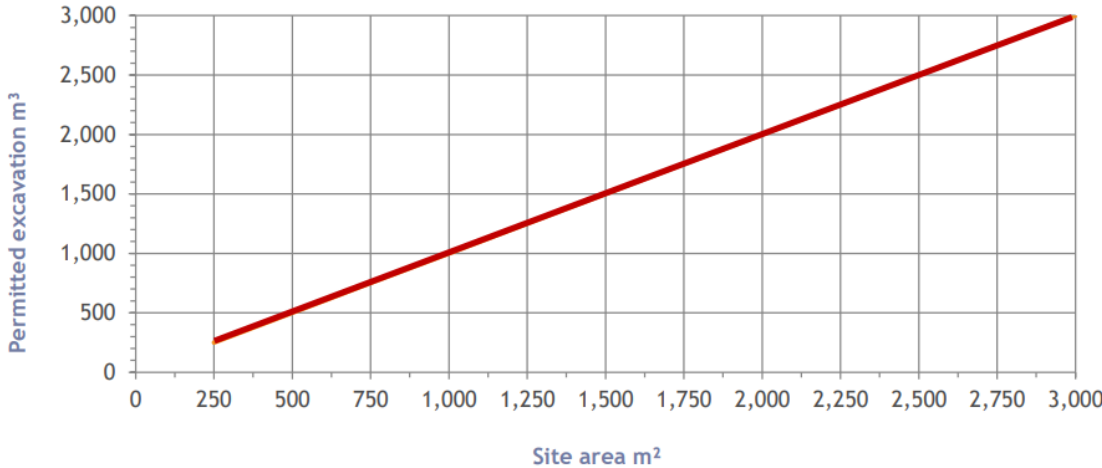


Figure 27 Maximum volume of excavation for any building type not mentioned in figure 26

## B14 ADVERTISING AND SIGNAGE

This Part specifies objectives and requirements for the erection and display of advertising signs. The controls within this section should be read in conjunction with *State Environmental Planning Policy (Industry and Employment) 2021*, *State Environmental Planning Policy (Exempt and Complying Development Codes) 2008* (Codes SEPP) and WLEP, which define what can be carried out as exempt development and override these controls.

### 14.1 DESIGN AND LOCATION

#### Objectives

- (a) To promote innovative, unique and creative signs that support retailers or businesses.
- (b) To deliver and maintain a high quality and cohesive public domain.
- (c) To maintain the architectural integrity of the subject building and adjacent buildings.
- (d) To ensure signage respects the architectural style of the building, contributes to the character of streetscape and is consistent with land uses.
- (e) To reduce energy consumption and minimise the negative amenity impacts of illuminated signs and advertisements.
- (f) To ensure the amenity of any adjacent non-commercial or residential uses.
- (g) To ensure the safety of pedestrians and traffic.
- (h) To ensure the harmony of signage with other features, having particular regard to the size and juxtaposition of other signs in the immediate vicinity.

#### Controls

##### 14.1.1 General Controls

- (a) Signage is to relate to the use of the building on which it appears and be designed to complement the established streetscape character, and not detract from significant views or vistas.
- (b) Signage is to be integrated into the architectural design of the building, awning or shop front (refer to Figure 28).
- (c) Where original sign panels have been incorporated into the parapet of the building facade, these should be used to identify the name or nature of the business only and not be used for advertising.
- (d) Signs should not obscure decorative forms or moulding and should observe a reasonable separation distance from the line of windows, doors, parapets, piers and the like.
- (e) The colour used in the design of a sign or structure should reflect the colour scheme of the building to which it will be attached.
- (f) Corporate colours should be limited to the advertising sign or structure.
- (g) Careful consideration should be given to the use of illuminated red, green and amber colours in proximity to signalised intersections.
- (h) Council may give consideration to temporary advertising in the form of bunting, banners, inflatable or canvas signs for special events provided that the temporary display period does not exceed four weeks.

- (i) Illuminated signage is to have no direct adverse impact on the amenity of residential properties.
- (j) Illumination of signs by floodlighting is preferable over the use of boxed fluorescent or neon lighting on buildings and places of architectural significance.
- (k) The use of neon tubing to highlight the features of a building is not permitted.
- (l) Flashing, moving or 3-D signs are not encouraged and will only be considered where permitted in this Part and after practical demonstration and a detailed assessment of any adverse impact on the amenity and character of the neighbouring area.
- (m) Signs are to be of a size and proportion that complement the scale of the existing façade, as well as surrounding buildings and signs.
- (n) Signage must not have a combined area in excess of 20m<sup>2</sup>.
- (o) Shopping arcades are encouraged to erect a business directory at each entrance.
- (p) The following will not be permitted:
  - (i) Wall signs projecting more than 300mm from the wall.
  - (ii) Flashing or moving signs.
  - (iii) Advertising on display window piers or below the display window sill/kick plate.
  - (iv) Sky, roof, or fin signs.
  - (v) The display of bunting, banners, canvas, or fabric signs.
  - (vi) Inflatable signs and the like.
  - (vii) Advertising on garbage bins, telegraph posts, telephone booths, or other surfaces of a public nature.
  - (viii) Any sign which in Council's opinion, would adversely affect the operation of traffic lights, motorists or obstruct their vision.
  - (ix) Third party advertising.
  - (x) A-Board (sandwich boards).
  - (xi) Advertising on canvas shade blinds.
  - (xii) Signs that extend over street frontage boundaries, unless approved in conjunction with a shop which is built to the street alignment.



Figure 28 Types of signage

---

**14.1.1 Third Party Advertising**

- (a) Advertising on garbage bins, telegraph posts and other surfaces of a public nature is not permitted, except by prior contractual arrangement with Council.
- (b) Advertising signage on buildings and shop fronts must only relate to businesses operating within the same building or shop. Third party advertising is not permitted.
- (c) Where multiple occupancies exist within a single building or shop front, a coordinated scheme for all advertising and signage is required.
- (d) Council will not approve third party advertising. Signage must relate to the use of the building or land it is on.

---

**14.1.2 Number of signs**

- (a) Signage should not dominate the façade of buildings.
- (b) The number of signs per building or site will be assessed on the following:
  - (i) Number of existing signs;
  - (ii) Proportion of solid (wall surface area) to void (window and door openings) available for signage;
  - (iii) Length of frontage of the premises; and
  - (iv) Extent of facade detail and dimensional relief on the building which should not be obscured by signage.

## 14.2 SITE SPECIFIC CONTROLS

### Objectives

- (a) To ensure signage is compatible with the intensity of use in each land use zone and does not detrimentally affect the appearance of the site or adjoining land.
- (b) To ensure that signage complements the existing character of the area.

### Controls

#### 14.2.1 Residential Zones

- (a) Any signage within a residential zone shall relate only to premises situated on the subject land and may specify any of the following:
  - (i) The purpose for which the land is used;
  - (ii) Identification and description of a person carrying on an occupation or business on the premises; and
  - (iii) Particulars of the goods or services dealt with on the premises.
- (b) Signs should be carefully designed to blend in with the established residential character.
- (c) Illuminated and electronic signs are not permitted.
- (d) A sign must not exceed 1m x 0.7m in size. The sign shall be affixed to the front façade of the dwelling or to the front boundary wall or fence.
- (e) In circumstances where there is no front fence, or where an existing fence does not have sufficient height to display a sign, and where the dwelling has a significant setback from the street front, Council will give consideration to the erection of a pole sign, having a height not greater than 2.8m.

#### 14.2.2 Bondi Junction

- (a) Illuminated signage on buildings exceeding eight storeys is visible from the Harbour. Notwithstanding its regional significance, it is not intended that Bondi Junction compete with the established illuminated skylines of the City of Sydney or North Sydney. Any corporate advertising on the Bondi Junction skyline should only be for the purpose of serving the immediate region.

#### 14.2.3 Campbell Parade

- (a) Projecting wall signs or flush wall signs above the awning of shops fronting Campbell Parade are not permitted with the exception of building identification signs.
- (b) Building identification signs shall be painted, identifying only the name of the building, and be traditionally located within the building parapet as a feature of the building.
- (c) Generally, neon signage is encouraged on window shop fronts and for under awning signs as an alternative to fluorescent illumination.

#### 14.2.4 Wairoa Avenue in the vicinity of Wallis Parade

- (a) Neon signage may be permitted inside the window display area, provided it is not animated or flashing, due to the proximity of these shops to adjacent residential development.
- (b) No illumination or electronic signs above the awning will be permitted.

#### 14.2.5 Neighbourhood shops

- (a) In areas located within *Part E3 Local Village Centres* or where shops or commercial premises exist in residential zones, such premises shall be restricted to the display of the following signs:
  - (i) One under awning sign;
  - (ii) An awning fascia sign;
  - (iii) Projecting wall sign;
  - (iv) Window signage; and
  - (v) One flush wall sign to each frontage or one top hamper sign having maximum dimensions 3m(W) x 1.5m(H).
- (b) Flush wall signs shall not be permitted on side walls facing adjoining residences (refer to Figure 29).
- (c) Animated, flashing signs and lights are not permissible.
- (d) Electrical conduits to illuminated signs are to be concealed or integrated into the relevant sign.
- (e) Shops shall consider the use of branded canvas shade blinds under the awning, in place of above awning advertising signs, as a means of retaining an appropriate neighbourhood scale. Such signage shall relate to the display of product logos and not involve the promotion of sales or specials. Signage shall occupy a maximum of 60% of the surface area of the blind and not involve fluorescent or iridescent paints.



Figure 29 Inappropriate location for flush wall signs

#### 14.2.6 Mixed development buildings

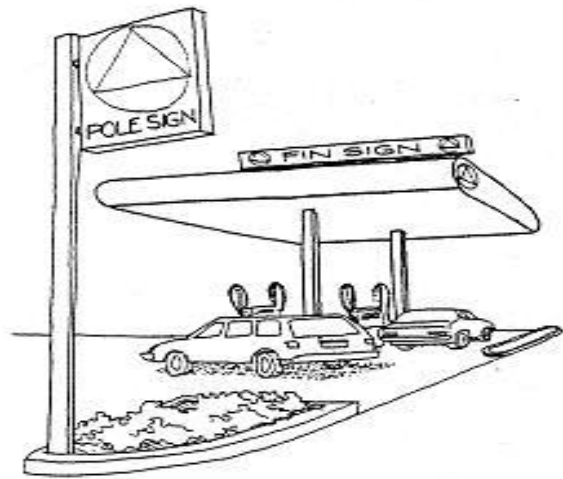
- (a) Advertising signs and structures shall not be permitted above the awning on mixed development buildings unless they relate to activities conducted above ground floor level.

**14.2.7 Development in excess of 15 metres in height**

- (a) Naming rights to the building, often in favour of the principal tenant, shall be limited to the form of one advertising sign above the awning. The sign shall be designed and positioned in a manner sympathetic to the design criteria of the building. Where no principal tenant exists, a coordinated approach shall be used in meeting the signage needs of the tenants of a building. This should generally be limited to a directory panel in the common area of the building.
- (b) Roof signs shall not be permitted where they exceed the height of the building, or where they are flashing or moving. The assessment of any proposed roof sign shall include an evaluation of its impact on adjacent residential development, in terms of intensity and duration of illumination.

**14.2.8 Automotive related activities**

- (a) Freestanding pole signs shall have a maximum height of 6 metres above ground level, and the sign itself shall not exceed 3.4m<sup>2</sup> in area.
- (b) Pole signs shall not project more than 750mm beyond street alignment (refer to Figure 30).
- (c) A fin sign positioned as such shall have a maximum height of 1.5m above the roof structure (refer to Figure 30). No portion of the sign shall project over Council's footpath. Fin signs shall have a maximum area of 9m<sup>2</sup> referring only to the name of the establishment. Only one fin sign shall be permitted on the premises.



**Figure 30** Example of pole and fin signs

---

**14.2.9 Heritage Significant Buildings**

- (a) Council will give consideration to architectural qualities of building when addressing the suitability of any proposed signs.
- (b) Signs must not conceal or obscure architectural features.
- (c) Generally, on shop fronts signage will be restricted to suspended under awning signs and awning fascia signs.
- (d) Signage above the awnings must be limited to appropriate areas allocated for such a purpose in the original facade design (parapets, for example), and must not extend above the parapet.
- (e) Flashing, electronic, illuminated or animated signs will not be permitted.
- (f) Council encourages restoration of original painted signs, and construction of new signs using traditional designs.
- (g) In the absence of any shop front awnings, signage shall be kept below the height of awnings on adjacent buildings. In such circumstances, projecting wall signs should take the form of lantern signs, where appropriate.



**14.3 SIGN SPECIFIC CONTROLS****Objectives**

- (a) To ensure that proposed signage is compatible the buildings and surrounding character of the area.

**Controls****15.4.1 Under-awning signs**

- (a) Under awning signs must:
  - (i) Have a minimum clearance of 2.6m above the footpath and be centrally positioned under the awning;
  - (ii) Not exceed 1.8m(W) x 300mm(H);
  - (iii) Be setback 600mm from the footpath edge;
  - (iv) Not project beyond the width of the awning; and
  - (v) Be separated from other under awning signs by 3m where practicable.

**14.3.2 Projecting Wall Signs**

- (a) Where permitted projecting wall signs shall:
  - (i) Extend a maximum projection of 750mm from the face of the wall (refer to Figure 31);
  - (ii) Have a minimum clearance of 2.6m above the footpath;
  - (iii) Not extend above parapet height;
  - (iv) Align with signs on adjacent buildings; and
  - (v) The vertical dimension of the sign shall be equal to or greater than the horizontal dimension.
- (b) Council will consider variations to the maximum projection requirement only where, in Council's opinion, the requirement for a sign of vertical proportion does not suit the style and character of the building, or details and proportions of the façade. In these instances square or circular signs may be considered, having a maximum projection of 1.5m from the facade. In such circumstances, buildings 3 storeys or greater are considered more appropriate to scale and proportion of such signs (refer to Figure 33).
- (c) Signs are to be attached to undecorated wall areas. Where projecting wall signs of vertical proportion are proposed, vertical engaged piers present on the facade of older buildings should be used.

**14.3.3 Awning fascia signs**

- (a) Fascia signs are to be flush with the awning and not illuminated.
- (b) They shall not project above or below the awning fascia.
- (c) Sign writing shall be limited to the street number, name and general nature of the business.
- (d) Product identification on an awning fascia shall not be permitted.
- (e) Where a building comprises a number of tenants, such as in an arcade, the awning fascia should identify the name of the arcade only.

---

**14.3.4 Flush Façade Panels**

- (a) Signs are to be attached to undecorated wall areas.
- (b) Façade panels should align with windows or doors or be centered on parapets (refer to Figure 32).
- (c) Opportunities may exist for flush wall signs on the blank side or rear walls of some buildings, provided that:
  - (i) The commodities or services advertised are sold within the premises to which the sign is affixed or painted;
  - (ii) The total area of signage is no greater than 4.5m<sup>2</sup>; and
  - (iii) The number of such signs is limited to one only.

---

**14.3.5 Top hamper signs**

- (a) Top hamper signs:
  - (i) May project up to 150mm from the building façade;
  - (ii) Must have a minimum clearance of 2130mm above ground level;
  - (iii) Shall have dimensions proportionate to the size of the top hamper fascia;
  - (iv) Shall not exceed 600mm in height, with a maximum length of 4000mm;
  - (v) Shall be restricted to one sign per premises, unless the Council considers the buildings frontage sufficient to accommodate more than one such sign;
  - (vi) Should not extend below the level of the head or doorway or window to which they are attached;
  - (vii) Should allow a proportion of the wall surface area of the top hamper to be exposed; and
  - (viii) Shall be set back 600mm from side boundaries to satisfy fire regulations.
- (b) Signs are to be within the perimeter of the building walls.
- (c) Illumination is permitted.

---

**14.3.6 Building Identification Sign**

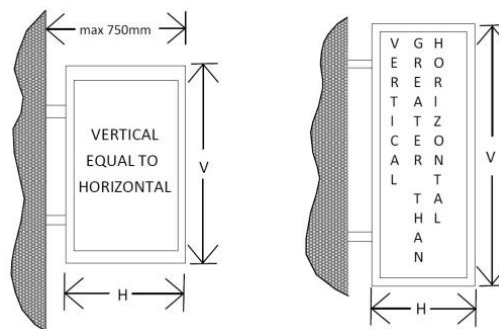
- (a) Building identification signs are to be located at building parapet height, for the purpose of identifying the building.
- (b) They will be permitted where, in Council's opinion, there is sufficient wall surface area to display the sign, and where the sign is proportionate to the façade area, and appropriate to the design and decoration of the building.
- (c) Where the building comprises a number of tenants, only one identification sign will be permitted where that tenant occupies floor space above awning level.
- (d) Building identification signs should be positioned at the local point of the building façade, generally central to the top parapet, and shall not project by more than 300mm from the wall.
- (e) Building identification signs shall be integrated with the character and form of the building and not alter its roofline.

### 14.3.7 Murals

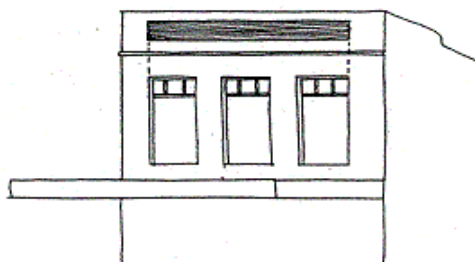
- (a) Council may consider the use of a mural as signage for the purposes of building identification and advertisement.
- (b) A mural is to be sensitive to the character and amenity of the area.
- (c) A mural must not be located on a heritage item or contributory building, or detract from the significance of a heritage conservation area.
- (d) Any corporate branding, logos, markings or similar are not to occupy more than 5% of the total mural area.
- (e) No third party advertisements are to feature in a mural.
- (f) If the mural contains no advertising material and does not act as signage, it may be considered as public art. If the mural is public art, it does not require development approval and is to be carried out in accordance with the *Waverley Public Art in the Private Domain Guidelines*.

### 14.3.8 Window signs

- (a) Painted signs on shop front windows, particularly those using fluorescent and iridescent paints, shall be temporary in nature, and not cover more than 60% of the window surface area (refer to Figure 34).
- (b) Painted window signage which is skeletal in form, identifying only the business name of the premises, may be permanently applied to the window surface.



**Figure 31** Dimensions for vertical projecting wall signs



**Figure 32** Preferred alignment of façade panels

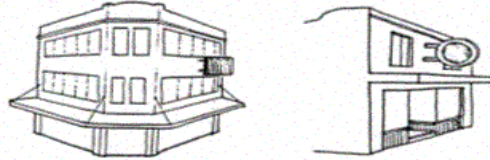
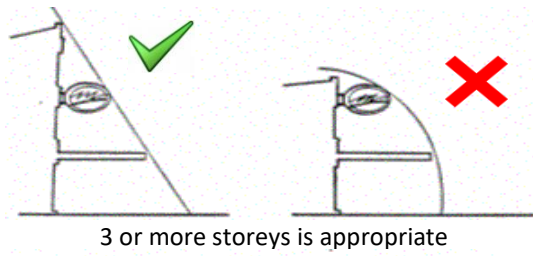


Figure 33 Signage for buildings with 3 or more storeys

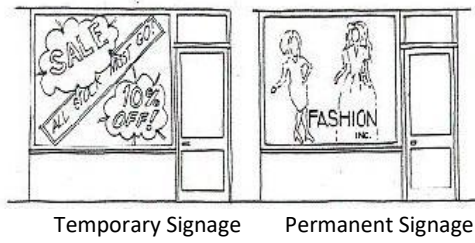


Figure 34 Painted shop front window sign

## B15 PUBLIC DOMAIN

The public domain is Waverley’s shared space for residents and visitors alike. It is important that development that addresses the public domain is attractive, safe and accessible. The public domain should be characterised by accessibility, excellence in design, high quality materials and well-integrated public art.

This Part is to be read in conjunction with Council’s Street Design Manual and Public Domain Technical Manual which provide further details on the application of the controls outlined in this Part.

### 15.1 IMPROVING THE PUBLIC DOMAIN

#### Objective

- (a) To ensure that the public domain receives adequate solar access.
  - (b) To protect significant views and vistas from the public domain.
  - (c) To ensure that development contributes to the activity, safety, amenity and quality of the public domain.
  - (d) To ensure that development adjoining the public domain is of a high quality.
  - (e) To provide legible and accessible development.
  - (f) To reinforce the character of the area.
  - (g) To minimise the use of, and ameliorate the effect of, blank walls at ground level.
  - (h) To minimise risks to the community of natural or environmental hazards, including urban heat islands or localised flooding.
  - (i) To maximise the accessibility and security of public open space.
- To improve nighttime movement and activation of street frontages.

#### Controls

- (a) Overshadowing effects of new buildings on publicly accessible open space is to be minimised between 9am – 3pm on 21 June.
- (b) Development is not to impede important or significant views from the public domain to public places, parks, Sydney Harbour or the eastern coastline, heritage buildings, monuments, or public artworks.
- (c) Development is to identify and improve key view corridors from the public domain.
- (d) Buildings are to be designed to frame important views from the public domain and within large sites.
- (e) Low level views of the sky along streets and from parks are to be maintained.
- (f) Buildings are to be designed to address the street and to utilise high quality finishes and public art to enhance the public domain and pedestrian interface.
- (g) Blank walls are not supported within centres. Where blank walls must be provided, utilise artworks or interesting façade designs to enrich the public domain.
- (h) Ground entry lobbies and commercial tenancies are to have entries at the same level as the adjacent footpath or public domain.

- (i) The ground floor of developments is to be designed so that there are regular opportunities for direct surveillance of the adjacent street or public domain.
- (j) Car parking areas at ground level must be screened by active uses to a minimum depth of 6m from the façade visible to the street or public domain.
- (k) Align setbacks between buildings with lanes and pedestrian links to enable clear lines of sight.
- (l) Ensure development manages and mitigates environmental or natural hazards, and does not exacerbate risks to existing developments or the public domain.
- (m) New residential flat building and shop top housing development may be required to provide street lighting to contribute to nighttime public safety.
- (n) Development involving the construction of a new residential flat building or shop top housing development are required to locate utility connections underground.
- (o) New residential flat building and shop top housing development will be required to provide footpath paving upgrades in accordance with the *Waverley Public Domain Technical Manual*.

## 15.2 ACTIVE STREET FRONTAGES

This Part applies to commercial and mixed use development that is subject to *Part E Site Specific Development* and/or that is marked on the WLEP Active Street Frontages Map

Active frontages include internal building spaces that have direct pedestrian access or visibility to the street and provide important centre activities such as commercial, civic and entertainment uses. These frontages contribute to the liveliness of a street, and are a key component of a people focused place.

Uses that can facilitate active frontages are any of the following:

- Entrance to retail;
- Shop front;
- Glazed entries to commercial and residential lobbies occupying less than 50% of the street frontage, to a maximum of 12m frontage;
- Café or restaurant if accompanied by an entry from the street;
- Active office uses, such as reception, if visible from the street; or
- Public building if accompanied by an entry.

### Objectives

- (a) To promote pedestrian activity and safety in the public domain
- (b) To provide a high degree of surveillance over the street.
- (c) To provide transparency and visual connection between the street and the building's interior.
- (d) To facilitate future adaptability and flexibility of uses.
- (e) To provide high standards of accessibility.
- (f) To supplement the WLEP controls for active street frontage.
- (g) To maximise the amount of active frontages throughout centres.
- (h) To ensure development encourages appropriate streetscape activation and active participation by the public.
- (i) To ensure that development provides a well-connected, weather protected public domain to reduce the impact of wind and rain and provide adequate shade for pedestrians.
- (j) To create a 'public face' for buildings to enhance the character of streets.
- (k) To promote a high level of visual connectivity and physical accessibility between the street and the active frontage premises.

### Controls

#### 15.2.1 General Controls

- (a) Development is to be constructed to the front property boundary.
- (b) Active ground floor uses are to be at the same general level as the footpath and be accessible directly from the street.
- (c) Sites identified as Active Street Frontage in this DCP must not provide vehicle access across the Active Street Frontage.
- (d) At ground level provide large, clear glazed windows with the sill at a minimum of 500mm above finished floor level.

- (e) Opaque or obscured glazing is not acceptable.
- (f) Reinforce corner frontages on primary shopping streets with shop or office front windows.
- (g) Openable shop fronts for restaurants or cafes and the like are encouraged, to a maximum of 80% of the façade.
- (h) Outdoor restaurants, cafes and the like are encouraged.
- (i) First level active frontages are encouraged. Some centres require first level active frontages, refer to *Part E Site Specific Development*.
- (j) Commercial ground floor frontages are to provide clear glazing where ever possible to promote passive surveillance and contribute to street activity.
- (k) One entrance to civic, entertainment, community, commercial or retail uses per 6m-10m of street frontage must be provided.
- (l) Provide regular tenancy widths, preferably between 6m-10m, or similar to adjacent shopfronts.
- (m) Development is to utilise a 500mm depth to articulate the building façade at ground level to create interest and variety in the streetscape. Ground level walls should be experienced as having depth and providing a transition between inside and outside. Modulation of the façade may include openings, setbacks, windows and doors, columns and structure.
- (n) Where carpark entrances must be located within an active frontage, innovative design solutions are to be provided that create an engaging or attractive entrance.
- (o) Where possible direct ramps and stairways into the depth of the tenancy instead of along a frontage, or provide access from a secondary frontage.
- (p) A variety of high-quality materials is to be used for active street frontages, with detailing that is of a human scale.
- (q) Active uses on levels that are setback are encouraged to look over the street, particularly on corner sites.
- (r) The context analysis submitted with the application is to determine whether the active frontage is in an area of predominantly traditional or contemporary shopfronts, and whether the frontage is on a primary or secondary shopping street. The design of the frontage is to comply with the relevant controls below. Refer also to any site specific controls in *Part E Site Specific Development*.

---

### 15.2.2 Shopfront Style

- (a) Development that is of a Traditional Shopfront style is to:
  - (i) Interpret and represent the design of adjacent Traditional Shopfronts.
  - (ii) Retain or rebuild any existing shopfronts, using construction techniques and materials that respect the original style, period and architecture of the building.
  - (iii) Provide between 40-80% of the ground level façade as glazing.
  - (iv) Articulate entrances in a similar manner to surrounding Traditional Shopfronts.
- (b) Development that is of a Contemporary Shopfront style is to:
  - (i) Have a high degree of articulation and diverse materiality.
  - (ii) Articulate entrances with inset doorways and thresholds.
  - (iii) Provide between 40-80% of the ground level façade as glazing.



---

**15.2.3 Primary Shopping Street Frontages**

- (a) Active frontages are to occur at ground level along all primary shopping streets.
- (b) Not more than 10% of the street frontage on a lot is to have blank walls or service areas (excluding structure, columns and beams).
- (c) On sites with wider frontages (over 10m) at least 85% of the building frontage is to be associated with retail uses such as entries, display area, café, restaurant and shop floor.
- (d) On sites with narrow frontages (under 10m) at least 70% of the building frontage is to be associated with retail uses such as entries, display area, café, restaurant and shop floor.

---

**15.2.4 Secondary Shopping Street Frontages**

- (a) At least 50% of the frontage is to be active frontage.
- (b) Not more than 15% of the street frontage can have blank walls or service areas (excluding structure, columns and beams).
- (c) No less than 80% of the building is to be aligned to the street.
- (d) Active uses on levels that are setback are encouraged to have active uses looking over the street, particularly on corner sites.

### 15.3 ARCADES AND THROUGH SITE LINKS

#### Objectives

- (a) To develop a comprehensive, compact, easy to follow, safe and accessible pedestrian network.
- (b) To increase permeability of large sites and within centres.
- (c) To ensure that arcades are safe and accessible.
- (d) To expand and enhance the public domain.
- (e) To promote pedestrian activity throughout centres.
- (f) To increase active street frontages throughout centres.
- (g) To provide continuity of retail throughout centres.

#### Controls

- (a) Potential street-to-street connections involving sites in separate ownership should consider liaising to develop compatible proposals and submitting concurrent applications to create new through site links.
- (b) Arcades and through site links must:
  - (i) Connect to a public street on both ends;
  - (ii) Be well lit and designed to minimise opportunities for loitering;
  - (iii) Incorporate high quality floor finishes;
  - (iv) Be in a straight alignment, bends or dog legs are not allowed;
  - (v) Have visual connection from street to street;
  - (vi) Provide an accessible path of travel from street to street;
  - (vii) Have a minimum width of 3m clear of all obstructions;
  - (viii) Be either open to the sky or with a glazed roof;
  - (ix) Be open for public use for at least between the hours of 7:00am and 10:00pm daily; and
  - (x) Have signage indicating public accessibility and the street to which the lane connects.

\*Refer to Figure 35 for a good example of a retail arcade with active frontages.
- (c) If a through site link is to be closed between 10:00pm and 7:00am via a gate or other mechanism, the gate must be latched into the 'open' position between 7:00am and 10:00pm, to allow an accessible path of travel.
- (d) Developments with public spaces such as arcades and through site links are to incorporate public art within the development (refer to *Part B11 Public Art*).
- (e) Arcades or through site links within any of the centres identified in *Part E Site Specific Development* must:
  - (i) Provide active frontages at the ground level, and in some cases first level, in accordance with *Section 16.2 Active Street Frontages*;
  - (ii) Maximise entries and display windows to shops and/or food and drink premises to increase pedestrian interest and interaction;
  - (iii) Provide elements of visual interest;
  - (iv) Provide predominantly retail, entertainment, civic or commercial uses;
  - (v) Provide a maximum of 15% of the frontage as the entry to a residential premise;
  - (vi) Provide one door per 4m; and
  - (vii) Provide not more than 10% of the frontage as blank walls or service areas (excluding structure, columns and beams).

- (viii) Adhere to Council's health policy by regular deep cleansing of the pedestrian access through the arcade.

## 15.4 AWNINGS AND COLONNADES

### Objectives

- (a) To increase the usability and amenity of public footpaths by protecting pedestrians from rain, strong winds, summer sunlight and glare.
- (b) To encourage pedestrian activity along streets to support and enhance the vitality of the local area.
- (c) To contribute to the character of the streetscape.
- (d) To ensure that heritage significance is taken into consideration in the application for awnings.

### Controls

- (a) Colonnades are not permitted in areas with active frontages.
- (b) Awnings are to be provided above all active frontages.
- (c) Continue the height, depth and form of existing awnings where they occur in the street.
- (d) Awnings are to provide a consistent height above the footpath with a minimum height between the footpath level and underside of awning of 3.1m.
- (e) Awnings should extend across the width of the footpath to within 0.6m of the kerb line.
- (f) Awning height is to be in the range 3.2m - 4.2m, with the final height determined to ensure continuity in appearance and weather protection with adjoining awnings.
- (g) Box awnings with slim fascias are to be provided.
- (h) Preferred awning depth is 3m.
- (i) Awnings are required to step with topography. Sloping awnings are discouraged.
- (j) Building entries must be covered.
- (k) The colour of awning fascias is to be consistent along the street.
- (l) Where street trees are required the entire length of the awning is to be set back from the kerb by 1.2m. Cut outs for trees and light poles in awnings are not acceptable.
- (m) To control sun access/protection, canvas blinds along the street edge may be permitted, subject to design merit and assessment.
- (n) Signage on blinds is not permitted.
- (o) Provide appropriate under awning lighting to facilitate night use and public safety.

## 15.5 REFLECTIVITY

### Objectives

- (a) To mitigate adverse glare from reflective surfaces on street level.
- (b) To ensure reflectivity does not impact upon the function of the public domain.
- (c) To minimise adverse solar reflection through the reduction of reflective materials and the use of shading devices.
- (d) To avoid façade treatments containing large areas of glazing.
- (e) To minimise potential impact on pedestrians and occupants of neighbouring buildings.

### Controls

- (a) Limit the use of large areas of glass in facades to a maximum of 60% of the façade surface area above ground level.
- (b) Shade glass areas with shading devices appropriate to the orientation. East and west-oriented glazing benefits from vertical shading devices, whilst north benefits more from horizontal shading devices.
- (c) Reflected solar glare on drivers should not exceed 500 candelas/m<sup>2</sup>. A candela is the base unit for measuring the intensity of luminance under the International System of Units (SI).
- (d) Mirrored glass and other highly reflective materials should not be used on building exteriors.
- (e) All panels and elements on vertical façades are to have a maximum specular reflectivity of visible light from normal angles of incidence of 20%.
- (f) Any surface inclined by more than 20 degrees to the vertical (inclined glass awnings or cladding on inclined roofs) are to have a maximum specular reflectivity of visible light from normal angles of incidence of 10%.
- (g) The above mentioned limits may need to be further reduced depending on the outcome of the analysis by a reflectivity consultant of the impact on drivers' visibility. Refer to the *Waverley Development Application Guide* for information about when a reflectivity report is required.

## 15.6 SHOPFRONT SECURITY

### Objectives

- (a) To improve the amenity of the public domain by discouraging roller shutters.
- (b) To promote engagement with shops and businesses after operating hours through window displays.
- (c) To prevent vandalism of shop fronts.

### Controls

- (a) Roller shutters on shop fronts are not permitted.
- (b) Applications involving a change of use of retail premises shall be required to retain or reinstate the window shop front.
- (c) Where the nature of the proposed retail activity does not warrant a window shop front display, consideration may be given to folding or sliding glass doors.
- (d) Security grilles on shop fronts are discouraged.
- (e) Where security grilles are to be provided, they may only be fitted internally behind the shopfront and are to be fully retractable and at least 50% transparent when closed.

## 15.7 MINOR ENCROACHMENTS

This section applies to the following structures that are permitted to encroach from private property onto public property:

- Awnings;
- Balconies;
- Shutters;
- Building signs;
- Decorative structures;
- Private security lighting;
- CCTV cameras; and
- Special drainage structures.

### Objectives

- (a) To ensure encroachments from private property onto public property are safe for pedestrians and vehicular traffic.
- (b) To ensure encroachments conserve the characteristics of an area.
- (c) To ensure that minor encroachments do not result in any loss of public amenity or safety and do not compromise future plans for road realignment or footpaths and stormwater drainage.
- (d) To allow architectural features that enhance the appearance of the building and streetscape.
- (e) To preserve and restore buildings which are a heritage item or located within a heritage conservation area

### Controls

---

#### 15.7.1 General

- (a) Encroachments are to be of a minor nature.
- (b) Encroachments must not pose a hazard, particularly to pedestrians or other users of public space.
- (c) Encroachments must be consistent with the character of the surrounding area.
- (d) Encroachments must:
  - (i) Be a maximum of 300mm;
  - (ii) Not interrupt pedestrian movement or public space or amenity;
  - (iii) Not enter into public space between ground/footpath level and 1m above ground/footpath level;
  - (iv) Not reduce the width of a footpath to less than 1.8 metres wide;
  - (v) Not extend over a vehicular carriageway; and
  - (vi) Must have a minimum setback of 600mm from the kerb face.

## B16 INTER-WAR BUILDINGS

This Part applies to Interwar buildings and is to be read in conjunction with the *Waverley Inter-War Building Design Guidelines*.

### Definition:

An Inter-War building is a building constructed in the period from c.1914 to c.1940, typically containing three or more residences. Buildings built between 1940 and 1950 with identifiable Inter-War characteristics are also considered to be Inter-War buildings.

### Objectives

- (a) To achieve the provisions of the *Waverley Inter-War Building Design Guidelines* as prepared by Council.
- (b) Encourage retention and appropriate conservation works including repair and maintenance of these buildings and their significant elements.
- (c) Encourage the removal of inappropriate alterations and additions and the reinstatement of original missing details and building elements.
- (d) Enhance the character of the streetscape and the broader Waverley Local Government Area.
- (e) Retain and enhance the landscape setting.
- (f) Facilitate design excellence and innovative approaches to alterations and additions in a way that enhances the essential characteristics of both the building and the streetscape without dominating the original building.
- (g) Facilitate upgrades in line with Australian Standards, the Building Code of Australia and other standard and codes whilst maintaining the character and significance of buildings.

### Controls

#### 16.1.1 General

- (a) All Inter-War Buildings should comply with Part B16 Inter War Buildings. Inter-War Buildings that are Heritage Items or located within a Heritage Conservation Area must also comply with the provisions of *Part B9 Heritage*.
2. With reference to the *Waverley Inter-War Building Design Guidelines*, the SEE and plans demonstrate the following:
  - (i) Locate the Inter War building and note if they are heritage items, located in a Heritage Conservation Area;
  - (ii) Identify the context of the street;
  - (iii) Identify the style of the building and the key defining features;
  - (iv) Identify the type of building;
  - (v) Determine the proposed level of modification;
  - (vi) Assess the proposal against the compliance check list;
  - (vii) Complete the compliance table.
- (c) Retain and maintain original building fabric and decorative elements such as parapets.



- (d) Provide maintenance and repairs where necessary utilising traditional techniques and materials.
- (e) Encourage the retention and maintenance of original decorative materials and finishes including fencing and light fixtures
- (f) Maintain and retain original face brickwork and stonework.
- (g) Preserve the building’s contribution to, and relationship with, the streetscape.
- (h) Alterations and additions are to be complementary and secondary to the existing building design.
- (i) Subtly differentiate new additions and alterations from the original building.
- (j) Minimise the visibility of new additions from the public domain and ensure that the original building remains dominant.
- (k) Demonstrate a high standard of design excellence.
- (l) Upgrade the systems within the building in line with the BCA, AS, DDA and other standards and codes as necessary; and
- (m) Maintain the integrity of the design of the building when providing upgrades to the building.
- (n) Development is required to apply a material or colour scheme in accordance with the *Waverley Inter-War Flat Building Heritage Design Guidelines*.
- (o) Any on-site car parking is to maintain the building’s relationship to the streetscape.
- (p) Comply with the conservation principles in Table 9.
- (q) Despite controls above, strict compliance with Table 9 may be varied if Council is satisfied that a proposal for alterations and additions can demonstrate innovation, design excellence and consistency with the objectives of this Part.

Building Element	Conservation Principles
Form and Massing	Explore the retention of simple prismatic masonry forms, simple hipped roof forms and respond to the character of the building
	Retain the principal form of the buildings.
Streetscape Elevation(s)	Retain the principal streetscape elevation(s).
Roof Finishes	Retain terracotta tile finishes or replace to match.
	Replace flat roofs as necessary.
Roof Parapet	Retain parapets and do not extend and reinstate where previously removed.
Wall Finishes	Retain decorative brickwork and do not paint or render face brickwork.
	Paint non original finishes in dark neutral tones to suggest face brickwork.
	Retain original textured render finishes (smooth, fan trowelled, roughcast).
	Retain original shingle finishes and original battened sheet finishes including projecting window bays.
Signage	Retain building name on façade or reinstate building name based on evidence.
Verandah	Retain original openings and do not infill original verandahs except in noisy locations where highly sympathetic additions may be appropriate.

	<p>Explore opening up of previous infilled verandah or replace glazing with frameless glazing.</p> <p>Retain the pattern and proportion of original windows and timber or steel finish.</p> <p>Replacements need to match the original proportion and finish.</p> <p>Retain proportion and glazing pattern of windows converted to doors.</p> <p>Remove external security bars and provide alternate security sympathetic to the style</p>
Fenestration	<p>Retain the pattern and proportion of original windows and timber or steel finish.</p> <p>Replacements need to match the original proportion and finish.</p> <p>Retain proportion and glazing pattern of windows converted to doors.</p> <p>Remove external security bars and provide alternate security.</p>
Entry	<p>Retain original timber French doors with multi pane glazing.</p> <p>Retain / restore porch.</p> <p>Retain original steps and simple pipe rail handrail.</p> <p>Retain terrazzo flooring, unglazed terracotta tiles, original concrete slab awnings and wall finishes</p> <p>Fire and safety and security upgrade discreet and retain original fabric.</p>
Stylistic Features	<p>Retain stylistic features listed in Style table (refer to <i>Waverley Inter-War Building Design Guidelines</i>) and reinstate lost features.</p>
Additions	<p>Minor additions should retain the overall form and character of the building.</p> <p>Minor additions should not be visually prominent from the street.</p>
Attic Conversion – storage and habitable	<p>Use of space in the roof form may be acceptable, with consideration of WLEP building height and floor space ratio development standards</p> <p>Control size and location of skylights and retain gable end finishes.</p> <p>Fenestration should respond to the scale and proportion of the existing fenestration.</p>
Inset Balcony	<p>Avoid inset balconies to visible roof planes.</p>
Dormers	<p>Front dormers are not acceptable.</p> <p>Rear dormers may be acceptable as they (are not visible from the street) have limited visibility.</p> <p>Side dormers should be proportional in scale with the existing roof, and may be acceptable depending on visual impact and impact on views.</p>
Roof Additions	<p>Roof additions are generally only supported where established surrounding streetscape scale is higher.</p> <p>Retain parapet and set back additions behind parapet to ensure skyline is retained.</p> <p>Use recessive finish detail and colour to minimise impact of additions.</p> <p>Minimise the thickness of the roof edge.</p>

	Setback privacy screens and dividing walls from parapet (planter solution) to ensure skyline is not interrupted.
Balconies	Balcony additions to rear only.
	Balcony should support stylistic characteristics and articulation of façade.
Undercroft Alterations	Re-use of laundries and undercroft areas is acceptable.
Rear Additions	Set down additions to the rear below the gutter height.
Fences and Gates	Retain original low masonry boundary fences and retain original materials.
	Do not raise height of fence. Use landscape to limit access and provide privacy.
Landscape	Retain landscape areas forward of building line and maximise landscape to street front.
	Use landscape to conceal mailboxes, bins and new ancillary facilities.
	Landscape – retain ‘crazy’ flagstone, fountains, approach paths and other hard landscaping features.
Parking	Retain original basement garage opening widths.
	Do not widen driveways and retain concrete wheel strips.
	Do not construct garages or carports in front setback or in front of buildings
	Pergolas may be appropriate to mitigate broad expanse of car stands.
	Recess garage doors.
Mailboxes	Retain original inset mailboxes built into fence.
	Expand in similar style as necessary or locate new mailboxes within landscape.
Interior	Modification of the interior can occur if there is no impact on the street facades.
Upgrades	Fire security upgrades must be discreet and respect original fabric.
	The character of the street presentation and foyer need to be retained as far as practical when implementing upgrades.
	Alternate solutions should be explored to allow the retention of the original fabric.

**Table 9:** Inter-War Building Conservation Principles

## 16.2 Shopfronts

- (a) Retain the original significant features including ingoes, signage, glazing pattern, location of doors, tiling and awnings.
- (b) Respect the original form, scale and detailing of the building and not compromise the integrity and consistency of the streetscape.
- (c) Aim to increase accessibility to the shopfront through permanent or temporary measures as deemed suitable in consultation with Council.

## B17 SOCIAL IMPACT ASSESSMENT

The *Waverley Social Impact Assessment Guidelines 2022* seek to highlight the importance of and guide the assessment of social impacts of proposed development. Applicants of all Development Applications should refer to the Guidelines to understand what Social Impact Assessment is and whether a Social Impact Statement is required for application lodgement.

### Objectives

- (a) To encourage positive social impacts and mitigate negative social impacts, and increase the validity and reliability of the Social Impact Assessment,
- (b) To maximise community benefits and encourage appropriate behaviours.
- (c) To reduce cumulative impact of development and ensure diversity in housing.
- (d) To ensure that the local community has input into the Social Impact Assessment.
- (e) To reduce interaction between children/students/sensitive beliefs and restricted premises/sex service patrons.
- (f) To increase access to public open space.
- (g) To identify preferred community consultation methods and key planning matters early.

### Controls

- (a) A Social Impact Statement (SIS) should be prepared if the proposed development is one of the following:
  - Loss of low-rental dwellings (see State Environmental Planning Policy Housing 2021 for definition)
  - Strata subdivision of 4 or more lots
  - \$10,000,000 or greater construction cost
  - Gross Floor Area of 3,000sqm or greater (see Waverley Local Environmental Plan for definition)
  - Reduction in dwelling numbers on site
 Council officers may request a SIS for development not included within the Guidelines at their discretion.
- (b) Plan of Management documents prepared as required by the Waverley Development Application Guide should be robust and adhered to.
- (c) Co-living development with the capacity to accommodate **20 or more lodgers** must have a full-time on-site manager accommodated within the premises.
- (d) Applicants must prepare a locality plan identifying the number and size of the same development type/land use within a **3km** radius, and justify how the addition of a development requiring an SIA will not produce an adverse cumulative impact given the context. This applies to the following development types:
  - Boarding house accommodation
  - Co-living housing development
  - Backpacker's accommodation
  - Pubs/registered clubs

## ANNEXURES

**Annexure B1-1****Examples of Building Material Reuse**

Material	Reuse/recycling potential
Concrete	Reused for filling, levelling or road base
Bricks and Pavers	Can be cleaned for reuse or rendered over or crushed for use in landscaping and driveways
Roof Tiles	Can be cleaned and reused or crushed for use in landscaping and driveways
Untreated Timber	Reused as floorboards, fencing, furniture, mulched or sent to second hand timber suppliers
Treated Timber	Reused as formwork, bridging, blocking and propping, or sent to second hand timber suppliers
Doors, Windows, Fittings	Sent to second hand suppliers
Glass	Reused as glazing or aggregate for concrete production
Metals (fittings, appliances and wiring)	Removal for recycling
Synthetic Rubber (carpet underlay)	Reprocessed for use in safety devices and speed humps
Significant Trees	Relocated either onsite or offsite
Overburden	Power screened and used as topsoil
Garden Waste	Mulched, composted
Carpet	Can be sent to recyclers or reused in landscaping
Plasterboard	Removal for recycling, return to supplier

Note: More information is available at the following link: <http://www.epa.nsw.gov.au/warr/index.htm>

**Annexure B1-2****Waste and Recycling Generation Rates****Residential Generation Rates**

Based on a survey of waste and recycling generation rates used across Sydney and Melbourne Councils in 2018, and NSW EPA Best Practice Resource Recovery in Residential Developments (2019) the minimum waste and recycling generation rates for residential dwellings are as follows:

<b>Generation Rates</b>				
<b>Dwelling type</b>	<b>General Waste (L/week)</b>	<b>Container Recycling (L/week)</b>	<b>Paper and cardboard Recycling (L/week)</b>	<b>Garden Organics Recycling (L/week)</b>
Single Unit Dwelling (House)	120	60	60	50
1 bedroom or studio	80	40	40	10
2 + bedroom unit	120	60	60	20

The following properties are considered residential under the *Local Government Act 1993*: Boarding houses/Time shares, Serviced apartments, Retirement village, and Independent living, and as such require a domestic waste service, incurring a Domestic Waste Charge. Co-living housing is also considered residential.

<b>Generation Rates</b>			
<b>Dwelling type</b>	<b>General waste L/unit/week</b>	<b>Container Recycling L/unit/week</b>	<b>Paper and cardboard recycling L/unit/week</b>
Boarding House/co-living housing/ Time Share studios with kitchen	60/apartment	30/apartment	30/apartment
Boarding House/co-living housing/ Time Share studios without kitchen	50/apartment	20/apartment	20/apartment
Serviced Apartments	35/apartment	20/apartment	20/apartment
Retirement Village	60/apartment	30/apartment	30/apartment
Independent Living	80/apartment	40/apartment	40/apartment

Use the figures above to quantify the total waste generation over a week and recycling generation over a fortnight. This will assist you to calculate the number of bins and hence the storage space required.

**Commercial Generation Rates**

## Annexures

Waste generation rates for commercial development are to be calculated using the rates below. Floor space includes patron usage area such as seating (indoor and outdoor). To ensure building flexibility for future uses, Council may require a higher generation rate than the proposed use.

Type of Premises	Garbage Generation	Recycling Generation
<b>Food Premises</b>		
Restaurants	660L*/100m <sup>2</sup> floor area/day	200 L/100m <sup>2</sup> floor area/day
Supermarkets	660L*/100m <sup>2</sup> floor area/day	240 L/100m <sup>2</sup> floor area/day
Greengrocer	660L*/100m <sup>2</sup> floor area/day	120 L/100m <sup>2</sup> floor area/day
Convenience Store	300 L/100m <sup>2</sup> floor area/day	150 L/100m <sup>2</sup> floor area/day
Café	300 L/100m <sup>2</sup> floor area/day	200 L/100m <sup>2</sup> floor area/day
Take away/Café (pre-packaged)	150 L/100m <sup>2</sup> floor area/day	150 L/100m <sup>2</sup> floor area/day
Butcher	300 L/100m <sup>2</sup> floor area/day	50 L/100m <sup>2</sup> floor area/day
Delicatessen	300 L/100m <sup>2</sup> floor area/day	50 L/100m <sup>2</sup> floor area/day
Fish shop	300 L*/100m <sup>2</sup> floor area/day	50 L/100m <sup>2</sup> floor area/day
Minimum generation when no food business type is specified	150 L/100m <sup>2</sup> floor area/day	50 L/100m <sup>2</sup> floor area/day
<b>Non Food Premises</b>		
Education and training	5L/100m <sup>2</sup> floor area/day or 0.5L/student/week	5L/100m <sup>2</sup> floor area/day or 0.5L/student/week
Offices	10L/100m <sup>2</sup> floor area/day	10L/100m <sup>2</sup> floor area/day
Shop (less than 100m <sup>2</sup> floor area)	50L/100m <sup>2</sup> floor area/day	25L/100m <sup>2</sup> floor area/day
Shop (greater than 100m <sup>2</sup> floor area)	50L/100m <sup>2</sup> floor area/day	50L/100m <sup>2</sup> floor area/day
Showroom	40L/100m <sup>2</sup> floor area/day	10L/100m <sup>2</sup> floor area/day
Warehouse	10L/100m <sup>2</sup> floor area/day	10L/100m <sup>2</sup> floor area/day
Childcare	80L/100m <sup>2</sup> floor area/day	80L/100m <sup>2</sup> floor area/day
Gym	10L/100m <sup>2</sup> floor area/day	10L/100m <sup>2</sup> floor area/day 50L (Penrith)
Hairdresser/Beauty Salon	60L/100m <sup>2</sup> floor area/day	60L/100m <sup>2</sup> floor area/day
<b>Accommodation</b>		
Student housing/Backpacker	40L/occupant/week	40L/occupant/week
Guesthouse	60L/occupant/week	60L/occupant/week
Hotel/Motel/Licensed club	5L/bed/day 50L/100m <sup>2</sup> bar area/day 400L/100m <sup>2</sup> dining area/day	5L/bed/day 50L/100m <sup>2</sup> bar area/day 280L/100m <sup>2</sup> dining area/day
Minimum generation when no non-food business type is specified	10L/100m <sup>2</sup> floor area/day	10L/100m <sup>2</sup> floor area/day

\*Decrease by half when organics recycling is implemented and increase by 10% if waste oil is generated (from deep frying).

*The above generation based on Randwick City Council's Waste Management Plan Guidelines, City of Melbourne Council's Waste Generation Rates (2015), Penrith City Council's Commercial Waste Generation Rates Guideline, and the NSW EPA Better Practice Guidelines for Waste Management and Recycling in Commercial and Industrial Facilities (2012)*

*For commercial waste streams that are not outlined above, supporting documentation is required to validate the proposed volumes for the respective waste streams.*

### **Mixed Use Developments**

Waste generation rates for mixed-use developments should use the above generation rates to estimate the combined waste generation from the residential and commercial components of the building.



**Annexure B1-3****Design Specification for Council Waste Collection Vehicles**

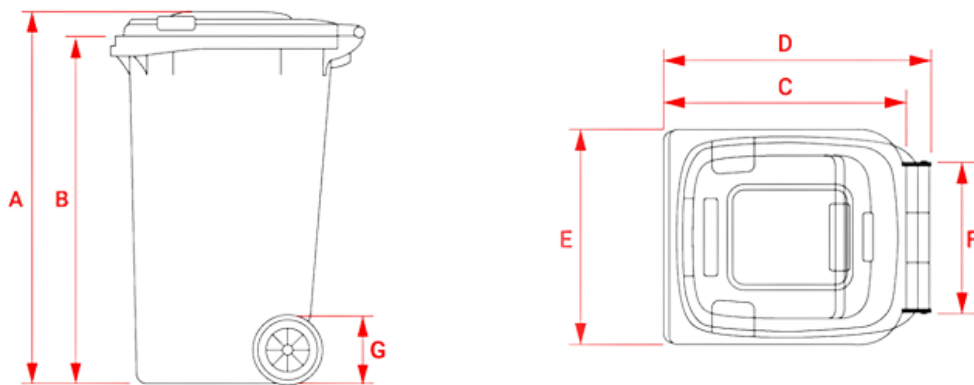
**Onsite Waste Facility Design Requirements** For residential or mixed developments proposing on-site collection, the site entry point, vehicle route of travel and manoeuvring envelopes shall comply in general with the requirements of Australian Standard AS 2890.2 Parking Facilities Part 2: Off Street Commercial Vehicle Facilities (AS 2890.2).

The onsite waste facility shall cater for the following:

<b>Design Vehicle</b>	<b>Requirement</b>
Overall Length (m)	10.5
Operational Length (m)	12.5
Design Width (m)	2.8
Design Height (m)	3.7
Clearance (travel height) (m)	4.5
Weight Fully Loaded (tonnes)	22.5
Capacity (m <sup>3</sup> )	24
Front Chassis Clearance	13°
Rear Chassis Clearance	16°

### Annexure B1-4 Council Supplied Bin Dimensions

Bin Type	80L	140L	240L	660L
A (TOTAL HEIGHT)	840mm	915 mm	1060 mm	1220 mm
B (BIN HEIGHT)	795mm	870 mm	990 mm	1090 mm
C (BIN DEPTH)	480mm	550 mm	660 mm	740 mm
D (TOTAL DEPTH)	510mm	615 mm	730 mm	780 mm
E (WIDTH)	450mm	535 mm	585 mm	1210 mm
F (HANDLE WIDTH)	300mm	395 mm	400 mm	980 mm
G (WHEEL DIAMETER)	200mm	200 mm	200 mm	200 mm



Source: Sulo Waste Management

**Annexure B1-5****Composting and Worm Farming Guidelines**

A composting facility must be provided in all residential use developments. Such facility may comprise either:

- A dedicated area on the site for the accommodation of a sufficient number of commercially available compost bins or worm farms, or
- A purpose designed compost area incorporated in the landscaped (low waste garden) area of the site.

**Location**

Conveniently accessible from all dwellings and reasonably close to the waste storage area. The facility should be located so as not to cause any nuisance to the occupants of the building on this or neighbouring sites.

**Size**

The capacity of compost bins for single dwellings is discretionary and will depend on the circumstances in the individual case. In new dwelling houses, an area of 1000mm x 1000mm should be provided.

In multi-residential buildings, provision should be made for:

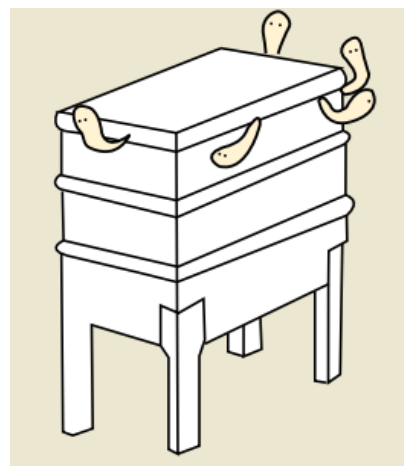
- A dedicated area to accommodate sufficient compost bins having a minimum capacity of 30 litres for each dwelling unit; or
- A purpose designed compost structure having a minimum capacity of 1 cubic metre for every 6 dwelling units or part thereof.

**Construction**

A permanent compost facility may be three-sided, two-compartment structure made of solid timber or masonry, with a cover for weather protection.



**Compost Bin**



**Worm Farm**

Examples of composting and worm farming containers and structures

**Note:** More information is available at <http://compostrevolution.com.au/>

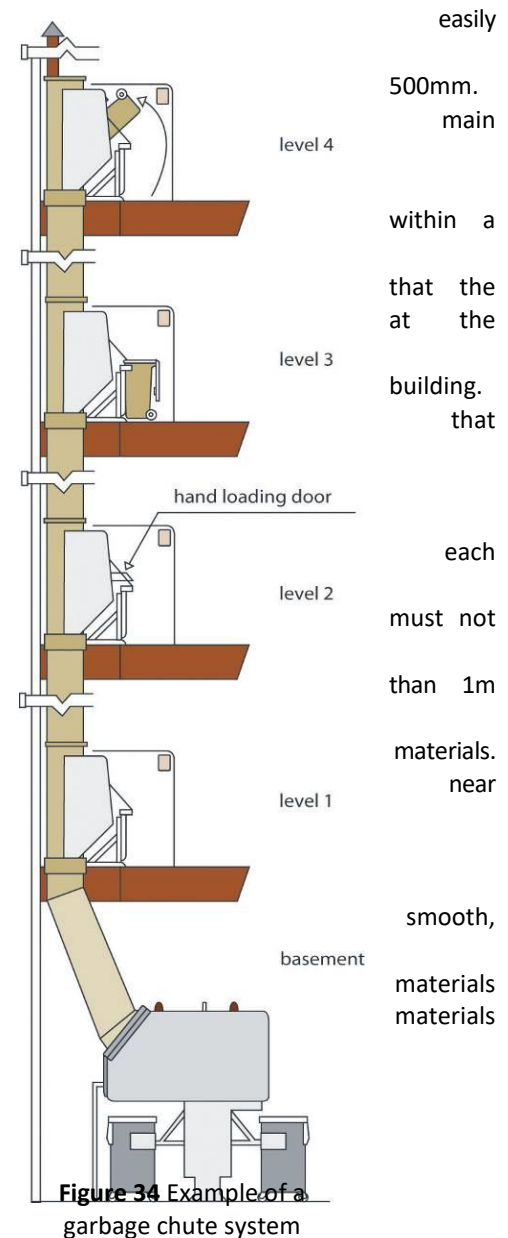
Where outdoor space is unavailable, smaller indoor composting systems are encouraged to be utilised within dwellings, and disposed of via Council's organic waste collection service.

**Annexure B1-6****Garbage Chutes, Compactors and Service Lifts Guidelines****Garbage chute design**

- Garbage chutes must be constructed in accordance with the requirements of the *Building Code of Australia (BCA)*.
- Garbage chutes must be located and insulated in a manner that reduces noise impacts.
- Chutes, service openings and charging devices must be constructed of material (such as metal) that is smooth, durable, impervious, non-corrosive and fire resistant.
- Chutes, service openings and charging devices must be capable of being cleaned.
- Chutes must be cylindrical and should have a diameter of at least 500mm.
- There must not be any bends (or sections of reduced diameter) in the shaft of the chute.
- Internal overlaps in the chute must follow the direction of waste flow.
- Chutes must deposit rubbish directly into a bin or compactor located within a waste/recycling storage room.
- A cut-off device must be located at or near the base of the chute so that the bottom of the chute can be closed when the bin or compacting device at the bottom of the chute is withdrawn or being replaced.
- The upper end of a chute should extend above the roofline of the building.
- The upper end of a chute should be weather protected in a manner that doesn't impede the upward movement of air out of the chute.

**Garbage chute service room design**

- The service opening (for depositing rubbish into the main chute) on floor of the building must be located in a dedicated service room.
- The charging device for each service opening must be self-closing and project into the main chute.
- Branches connecting service openings to the main chute are to be no more than 1m long.
- Each service room must include containers for the storage of recyclable materials. Signage regarding the materials that can be recycled should be displayed near these containers.
- Each service room must be located for convenient access by users and must be well ventilated and well lit.
- The floors, walls and ceilings of service rooms must be finished with smooth, durable materials that are capable of being easily cleaned.
- Service rooms must include signage that clearly describes the types of materials that can be deposited into the garbage chute and the types of materials which should be deposited into recycling bins.



### Management

- Garbage chutes are not to be used for the disposal of recyclable materials. Signage to this effect should be displayed near service openings.
- Arrangements must be in place for the regular maintenance and cleaning of garbage chutes and any associated service rooms, service openings and charging devices.
- Arrangements must be in place for the regular transferal of recyclable materials (which are stored in service rooms) to the main waste/recycling storage room.

### Service Lifts

- A service lift (or service elevator) may be appropriate in place of a waste chute in developments where a caretaker is to be employed.
- A service lift is a dedicated elevator system for the transport of waste and recycling containers and other equipment required for the operation of the development.
- A waste service compartment must be provided on each floor of the development to allow residents to store waste and recyclables.
- Residents place their waste and recyclables in bins provided and these are transported daily by the caretaker to the waste storage room.
- Each service room must be designed with sufficient space for the storage of two days waste and recycling for all residents on that level.
- Applicants will need to check with Council whether this option is acceptable.

### Compactors

- Compactors are used to compress the waste (or recyclables) into smaller collection containers.
- The compaction ratio is typically set at around 2:1. Higher ratios are not used as they may result in heavier bins, causing OH&S problems, mechanical damage and breakage of recyclable materials.
- Best practice compaction systems compact directly into a 240 litre bin or a skip, reducing the requirement of manually loading the compacted waste into bins or skips.
- Compactors are extremely useful for mixed garbage, if used for recyclables extreme care must be taken not to cross contaminate the recycling streams.
- Compactors are less useful for steel containers and should not be used for glass.
- Compactors require regular maintenance. In particular, systems fed from a chute can be prone to blockages or failure of the “electronic eye”, which can result in garbage overflowing or backing up the chute. As a result if the 2:1 compaction ratio, the requirement for garbage storage bins is halved. This information was sourced from: Resource NSW (The Department of the Environment and Conservation), “Better Practice Guide for Waste Management in Multi-Unit Dwellings”, 2002.

Source: *Better Practice Guide for Waste Management in Multi-Unit Dwellings, DECC, 2008.*

**Annexure B1-7****Placing a Waste Storage Container in a Public Place**

To place a waste storage container (skip) in a public place, such as on a roadway or footpath, a Building Waste Container Company registered with Council must be used.

For the purposes of this Part, a waste storage container means a bulk container, commonly known as a skip, that is used for the temporary storage and transportation (by a registered vehicle) of waste and recycling materials generated by building demolition and construction activities, as well as general household rubbish. Also for the purposes of this Part, a public place means the whole of a public roadway, including any footway and grass verge, but does not include a public park or reserve which is land used for public recreation and like purposes.

A waste container may be placed in a public place, only where there is no suitable space available on the user's premises. Council permits this to encourage source separation and recycling of waste materials. Council encourages the use of multiple containers or careful scheduling of single container collections to enable separation of re-useable and recyclable materials. Details of the container must be marked on the plans presented to Council when applying for a construction certificate.

**Approval Requirements**

Permission to supply and locate a building waste container / skip is granted subject to compliance with the following conditions:

1. The Company holds a current Council permit to place a waste storage container in a public place;
2. The Company have lodged an appropriate security deposit with Council to cover the costs for repair of any damage caused to public property;
3. Containers will be positioned in conformity with the "Interim Guidelines for the Placement of Building Waste Containers" as prepared by the Roads and Traffic Authority of N.S.W;
4. Containers shall not exceed a width of 2.5m;
5. No containers shall be located in a public reserve without the prior approval of Council;
6. Containers shall not be left on a roadway longer than seven (7) days;
7. Containers shall bear the name and telephone number of the supplier;
8. Suppliers agree that the site where containers are being placed will be left in a clean and tidy condition with all spillage removed from the area;
9. Suppliers are to be responsible for any incidence of damage arising from poor placement of containers or spilt debris; and
10. Suppliers are to agree in writing to indemnify Council against any public liability claim arising from the placement of containers on Council's roadways and such insurance cover to indemnify Waverley Council for a minimum amount of \$10,000,000.

When placing a waste storage container / skip in a public place the following provisions must be complied with:

1. Public safety and convenience must be preserved;
2. The container will not cause any damage to public property;
3. The container is a size appropriate to the location;
4. The container is clearly identifiable;
5. The container is clearly visible to traffic;
6. The container does not restrict or obstruct traffic visibility;
7. The container does not disturb or obstruct the free flow of pedestrian or vehicular traffic; and
8. The container does not disturb normal stormwater flow.

### Annexure B3-1 Planting List

All species on this list are generally recommended for use throughout Waverley, however, the selection of appropriate plant species for each site should be recommended by a suitably qualified landscape or bushland regeneration professional. Alternative species may be approved by Council.

It is strongly recommended that the sourcing of plant material is undertaken well in advance of any development to ensure availability of species required.

Please note that Hedging of any *trees* (such as Lilly Pillies) will result in their classification as shrubs for the purposes of applying these controls. Note that some of the species in the *shrubs medium – large* section can be classified as trees, depending on their height at maturity and number of stems.

TREES	
Botanical Name	Common Name
<i>Acacia decurrens</i>	Sydney Green Wattle
<i>Acacia implexa</i>	Hickory Wattle
<i>Acacia irrorata ssp. irrorata</i>	Green Wattle
<i>Acacia longissiuma</i>	Long-leaf Wattle
<i>Acacia parramattensis</i>	Sydney Green Wattle
<i>Acmena smithii</i>	Lilly Pilly
<i>Acronychia oblongifolia</i>	White Aspen
<i>Allocasuarina littoralis</i>	Black She-oak
<i>Allocasuarina torulosa</i>	Forest Oak
<i>Angophora costata</i>	Sydney Red Gum
<i>Angophora hispida</i>	Dwarf Apple
<i>Archontophoenix cunninghamiana</i>	Bangalow Palm
<i>Backhousia citriodora</i>	Lemon Myrtle
<i>Backhousia myrtifolia</i>	Grey Myrtle
<i>Banksia integrifolia</i>	Coastal Banksia
<i>Banksia marginata</i>	Silver Banksia
<i>Callicoma serratifolia</i>	Black Wattle
<i>Casuarina glauca</i>	Swamp Sheoak
<i>Ceratopetalum apetalum</i>	Coachwood
<i>Corymbia gummifera</i>	Red Bloodwood
<i>Cupaniopsis anacardioides</i>	Tuckeroo
<i>Elaeocarpus reticulatus</i>	Blueberry Ash
<i>Enidandra sieberi</i>	Corkwood
<i>Eucalyptus botryoides</i>	Bangalay
<i>Eucalyptus gummifera</i>	Red Bloodwood
<i>Eucalyptus haemastoma</i>	Scribbly Gum
<i>Eucalyptus piperita</i>	Sydney Peppermint
<i>Eucalyptus obstans</i>	Port Jackson Mallee
<i>Eucalyptus robusta</i>	Swamp Mahogany
<i>Ficus rubiginosa</i>	Port Jackson Fig
<i>Ficus coronata</i>	Sandpaper Fig
<i>Glochidion ferdinandi</i>	Cheese Tree
<i>Hymenosporum flavum</i>	Native Frangipani
<i>Livistona australis</i>	Cabbage Palm

<i>Melia azederach var. australasica</i>	White Cedar
<i>Notelaea longifolia</i>	Large Mock-olive
<i>Pittosporum revolutum</i>	Yellow Pittosporum
<i>Podocarpus elatus</i>	Plum Pine
<i>Syzygium leuhmannii</i>	Riberry
<i>Syzygium paniculatum</i>	Magenta Lilly Pilly
<i>Syncarpia glomulifera ssp glomulifera</i>	Turpentine
<i>Toona ciliata</i>	Red Cedar
<i>Tristainiopsis laurina</i>	Water Gum

SHRUBS: Medium-Large	
Botanical Name	Common Name
<i>Acacia binervia</i>	Coast Myall
<i>Acacia linifolia</i>	White Wattle
<i>Acacia longifolia</i>	Sydney Golden Wattle
<i>Acacia floribunda</i>	White Sally Wattle
<i>Acacia sophorae</i>	Coastal Wattle
<i>Acacia terminalis</i>	Sunshine Wattle
<i>Allocasuarina distyla</i>	Shrubby She-oak
<i>Banksia aemula</i>	Wallum Banksia
<i>Banksia ericifolia</i>	Heath-leaved Banksia
<i>Banksia oblongifolia</i>	Fern-leaved Banksia
<i>Banksia marginata</i>	Silver Banksia
<i>Banksia serrata</i>	Old Man Banksia
<i>Callistemon linearifolius</i>	Netted Bottlebrush
<i>Callistemon pinifolius</i>	Pine-leaved Bottlebrush
<i>Callistemon salignus</i>	Willow Bottlebrush
<i>Ceratopetalum gummiferum</i>	NSW Christmas Bush
<i>Cordyline stricta</i>	Slender Palm Lily
<i>Cyathea cooperi</i>	Rough Tree Fern
<i>Dicksonia antarctica</i>	Soft Tree Fern
<i>Eupomatia laurina</i>	Bolwarra
<i>Grevillea linearifolia</i>	Linear-leaf Grevillea
<i>Grevillea mucronulata</i>	Green Spider Flower
<i>Grevillea speciosa</i>	Red Spider Flower
<i>Grevillea sphacelata</i>	Grey Spider Flower
<i>Hakea dactyloides</i>	Finger Hakea
<i>Hakea gibbosa</i>	Needlebush
<i>Hakea teretifolia</i>	Dagger Hakea
<i>Kunzea ambigua</i>	Tick Bush
<i>Lambertia formosa</i>	Mountain Devil
<i>Leptospermum laevigatum</i>	Coastal Tea Tree
<i>Leptospermum polygalifolium</i>	Yellow tea-tree
<i>Leptospermum squarrosum</i>	Pink tea-tree
<i>Lomatia myricoides</i>	River Lomatia
<i>Melaleuca armillaris</i>	Bracelet Honey-myrtle
<i>Melaleuca linariifolia</i>	Flax-leaved Paperbark



<i>Melaleuca nodosa</i>	Ball Honey-myrtle
<i>Monotoca elliptica</i>	Tree Broom-heath
<i>Myrsine variabilis</i>	Variable Muttonwood
<i>Persoonia levis</i>	Broad-leaved Geebung
<i>Persoonia linearis</i>	Narrow-leaved Geebung
<i>Polyscias sambucifolia</i>	Elderberry Panax
<i>Viminaria juncea</i>	Native Broom

SHRUBS: Small-Medium	
Botanical Name	Common Name
<i>Acacia myrtifolia</i>	Myrtle Wattle
<i>Acacia longifolia</i> ssp. <i>sophorae</i>	Coastal Wattle
<i>Acacia suaveolens</i>	Sweet Wattle
<i>Acacia terminalis</i>	Sunshine Wattle
<i>Acacia ulicifolia</i>	Prickly Moses
<i>Baeckea imbricata</i>	Heath Myrtle
<i>Baeckea linifolia</i>	Swamp Baeckea
<i>Banksia robur</i>	Swamp Banksia
<i>Banksia spinulosa</i>	Hair-pin Banksia
<i>Bauera rubioides</i>	River Dog Rose
<i>Bossiaea heterophylla</i>	Variable bossiaea
<i>Brachyloma daphnoides</i>	Daphne Heath
<i>Breynia oblongifolia</i>	Coffee Bush
<i>Callistemon citrinus</i>	Crimson Bottlebrush
<i>Callistemon linearis</i>	Narrow-leaved Bottlebrush
<i>Correa alba</i>	Coastal Correa
<i>Correa reflexa</i>	Native Fuchsia
<i>Crocea saligna</i>	Crocea
<i>Darwinia fascicularis</i>	Darwinia
<i>Dillwynia retorta</i>	Parrot Pea
<i>Dodonaea triquetra</i>	Common Hop Bush
<i>Eriostemon australasius</i>	Pink Wax Flower
<i>Grevillea linearifolia</i>	Linear-leaf Grevillea
<i>Grevillea mucronulata</i>	Green Spider Grevillea
<i>Grevillea speciosa</i>	Red Spider Grevillea
<i>Grevillea sphacelata</i>	Grey Spider Grevillea
<i>Lambertia formosa</i>	Mountain Devil
<i>Lasiopetalum ferrugineum</i>	Rusty Petals
<i>Lomatia silaifolia</i>	Crinkle Bush
<i>Melaleuca thymifolia</i>	Thyme Honey-myrtle
<i>Olearia tomentosa</i>	Daisy Bush
<i>Ozothamnus diosmifolius</i>	Rice Blower
<i>Pimelea linifolia</i>	Slender Rice flower
<i>Platysace lanceolata</i>	Native Parsnip
<i>Phebalium squamulosum</i>	Forest Phebalium
<i>Prostanthera incisa</i>	Toothed Mint Bush

<i>Pultenaea linophylla</i>	<i>Halo Bush Pea</i>
<i>Ricinocarpus pinifolius</i>	<i>Wedding Bush</i>
<i>Westringia fruticosa</i>	<i>Coastal Rosemary</i>

<b>GRASSES and GROUNDCOVERS – Upright Grasses, Lillies, Rushes and Sedges</b>	
<b>Botanical Name</b>	<b>Common Name</b>
<i>Alocasia brisbanensis</i>	<i>Cunjevoi</i>
<i>Austrostipa pubescens</i>	<i>Spear Grass</i>
<i>Baumea juncea</i>	<i>Bog Rush</i>
<i>Crinum pedunculatum</i>	<i>Swamp Lily</i>
<i>Cymbopogon refractus</i>	<i>Barbed Wire Grass</i>
<i>Dianella caerulea</i>	<i>Blue Flax Lily</i>
<i>Dianella congesta</i>	<i>Coastal Flax Lily</i>
<i>Dianella revoluta</i>	<i>Paroo Lily</i>
<i>Dichelachne crinita</i>	<i>Long Hair Plume Grass</i>
<i>Dichelachne micrantha</i>	<i>Short Hair Plume Grass</i>
<i>Echinopogon caespitosus</i>	<i>Tufted Hedgehog Grass</i>
<i>Entolasia marginata</i>	<i>Bordered panic Grass</i>
<i>Entolasia stricta</i>	<i>Wiry Panic Grass</i>
<i>Ficinia nodosa</i>	<i>Knobby Club Rush</i>
<i>Gahnia sieberiana</i>	<i>Saw Sedge</i>
<i>Imperata cyllindrica</i>	<i>Blady Grass</i>
<i>Juncus usitatus</i>	<i>Common Rush</i>
<i>Juncus krausii</i>	<i>Sea Rush</i>
<i>Lachnagrostis billardierei</i>	<i>Coast Blown Grass</i>
<i>Lomandra longifolia</i>	<i>Spiny-headed Mat rush</i>
<i>Machaerina juncea</i>	<i>Bare Twig-rush</i>
<i>Paspalidium distans</i>	<i>Shotgrass</i>
<i>Poa affinis</i>	<i>Tussock Grass</i>
<i>Rytidosperma fulvum</i>	<i>Wallaby Grass</i>
<i>Themeda australis</i>	<i>Kangaroo Grass</i>
<i>Themeda australis</i> Coastal form	<i>Kangaroo Grass (Coastal Form)</i>
<i>Xanthorrhoea resinosa</i>	<i>Grass Tree</i>

<b>GRASSES and GROUNDCOVERS – Herbs and Subshrubs</b>	
<b>Botanical Name</b>	<b>Common Name</b>
<i>Austromyrtus tenuifolia</i>	<i>Midgenberry</i>
<i>Brachyloma daphnoides</i>	<i>Daphne Heath</i>
<i>Geranium homeanum</i>	<i>Cranesbill</i>
<i>Gonocarpus teucrioides</i>	<i>Germander Raspwort</i>
<i>Homoranthus flavescens</i>	<i>Homoranthus</i>
<i>Leucopogon ericoides</i>	<i>Pink Beard-heath</i>
<i>Leucopogon juniperinus</i>	<i>Prickly Beard-heath</i>
<i>Lomandra glauca</i>	<i>Pale Mat-rush</i>
<i>Lomatia silafolia</i>	<i>Crinkle Bush</i>
<i>Mirbelia rubiifolia</i>	<i>Heathy Mirbelia</i>

<i>Pelargonium australe</i>	<i>Austral Stork's Bill</i>
<i>Plectranthus parviflorus</i>	<i>Cockspur flower</i>
<i>Wahlengergia gracilis</i>	<i>Sprawling Bluebell</i>
<i>Xerochrysum bracteatum</i>	<i>Paper Daisy</i>

GRASSES and GROWDCOVERS – Climbers and Twiners	
Botanical Name	Common Name
<i>Billardiera scandens</i>	<i>Hairy Appleberry</i>
<i>Cissus antarctica</i>	<i>Kangaroo Vine</i>
<i>Cissus hypoglauca</i>	<i>Five-leaf Water Vine</i>
<i>Eustrephus latifolius</i>	<i>Wombat Berry</i>
<i>Geitonoplesium cymosum</i>	<i>Scrambling Lily</i>
<i>Glycine clandestina</i>	<i>Love Creeper</i>
<i>Gynochthodes jasminoides</i>	<i>Sweet Morinda</i>
<i>Hardenbergia violacea</i>	<i>False Sarsaprilla</i>
<i>Hibbertia dentata</i>	<i>Trailing Guinea-flower</i>
<i>Hibbertia scandens</i>	<i>Golden Guinea Flower</i>
<i>Hoya australis</i>	<i>Australian Wax Plant</i>
<i>Pandorea pandorana</i>	<i>Wonga Wonga Vine</i>
<i>Smilax glycyphylla</i>	<i>Sweet Sarsaparilla</i>
<i>Stephania japonica</i> var. <i>discolor</i>	<i>Snake Vine</i>

GRASSES and GROWDCOVERS – Low grasses and groundcovers	
Botanical Name	Common Name
<i>Carpobrotus glaucescens</i>	<i>Pig Face</i>
<i>Carex pumila</i>	<i>Strand Sedge</i>
<i>Centella asiatica</i>	<i>Gotu Cola</i>
<i>Commelina cynaea</i>	<i>Scurvy Weed</i>
<i>Dichondra repens</i>	<i>Kidney Weed</i>
<i>Eragrostis brownii</i>	<i>Blown Grass</i>
<i>Lomandra glauca</i>	<i>Pale Mat-Rush</i>
<i>Microleana stipoides</i>	<i>Weeping Grass</i>
<i>Oplismenus aemulus</i>	<i>Basket Grass</i>
<i>Oplismenus imbecillis</i>	<i>Basket Grass</i>
<i>Scaevola calendulacea</i>	<i>Coastal Fan Flower</i>
<i>Selleria radicans</i>	<i>Swamp Weed</i>
<i>Tetragonia tetragonioides</i>	<i>Warrigal Greens</i>
<i>Viola hederacea</i>	<i>Native Violet</i>
<i>Zoysia macrantha</i>	<i>Prickly Marine Couch</i>

GRASSES and GROWDCOVERS – Ferns	
Botanical Name	Common Name
<i>Adiantum aethiopicum</i>	<i>Maidenhair Fern</i>
<i>Asplenium australasicum</i>	<i>Birds Nest Fern</i>
<i>Calochlaena dubia</i>	<i>Soft Bracken</i>
<i>Doodia aspera</i>	<i>Rasp Fern</i>
<i>Histiopteris incisa</i>	<i>Bats Wing Fern</i>

<i>Hypolepis muelleri</i>	Harsh Ground Fern
<i>Pellaea falcata</i>	Sickle fern
<i>Pteridium esculentum</i>	Common Bracken
<i>Sticherus flabellatus</i>	Umbrella Fern

### Annexure B3-2 Tree Canopy Replacement Planting List

Replacement Plantings	
Botanical Name	Common Name
<i>Araucaria columnaris</i>	Cook Island Pine or New Caledonia Pine
<i>Araucaria heterophylla</i>	Norfolk Island Pine
<i>Casuarina equisetifolia</i>	Horsetail Casuarina
<i>Livistona australis</i>	Cabbage Tree Palm
<i>Melaleuca armillaris</i>	Bracelet Honey Myrtle
<i>Melaleuca lanceolata</i>	Moonah
<i>Metrosideros spp</i>	New Zealand Christmas Bush
<i>Washingtonia robusta</i>	Cotton Palm
<i>Acacia decurrens</i>	Sydney Green Wattle
<i>Acacia fimbriata</i>	Fringed Wattle
<i>Acacia implexa</i>	Hickory Wattle
<i>Acacia irrorata ssp. irrorata</i>	Green Wattle
<i>Acacia longissima</i>	Long-leaf Wattle
<i>Acacia parramattensis</i>	Sydney Green Wattle
<i>Acacia sophorae</i>	Coastal Wattle
<i>Acmena ingens</i>	Red Apple
<i>Acmena smithii</i>	Lilly Pilly
<i>Acronychia oblongifolia</i>	White Aspen
<i>Agonis flexuosa 'After Dark'</i>	Purple-leafed Willow Myrtle
<i>Alectryon coriaceus</i>	Beach Birds Eye
<i>Allocasuarina littoralis</i>	Black She-oak
<i>Allocasuarina torulosa</i>	Forest Oak
<i>Angophora costata</i>	Sydney Red Gum
<i>Angophora hispida</i>	Dwarf Apple
<i>Araucaria columnaris</i>	Cook Island Pine or New Caledonia Pine
<i>Araucaria heterophylla</i>	Norfolk Island Pine
<i>Archontophoenix cunninghamiana</i>	Bangalow Palm
<i>Backhousia citriodora</i>	Lemon Myrtle
<i>Backhousia myrtifolia</i>	Grey Myrtle
<i>Banksia integrifolia</i>	Coastal Banksia
<i>Banksia marginata</i>	Silver Banksia
<i>Banksia serrata</i>	Old Man Banksia
<i>Brachychiton acerifolius</i>	Illawarra Flame Tree
<i>Buckinghamia celsissima</i>	Ivory Curl Tree
<i>Callicoma serratifolia</i>	Black Wattle
<i>Callistemon</i>	Bottlebrush
<i>Callistemon 'Dawson River'</i>	Weeping Bottlebrush
<i>Callistemon citrinus *</i>	Lemon-Scented Bottlebrush
<i>Callistemon 'Dawson River'</i>	Weeping Bottlebrush

<i>Callistemon salignus</i>	Willow Bottlebrush
<i>Callitris rhomboidea</i>	Port Jackson Pine
<i>Casuarina glauca</i>	Swamp Sheoak
<i>Ceratopetalum gummiferum</i>	NSW Christmas Bush
<i>Ceratopetalum apetalum</i>	Coachwood
<i>Corymbia eximia</i>	Yellow Bloodwood
<i>Corymbia gummifera</i>	Red Bloodwood
<i>Cupaniopsis anacardioides</i>	Tuckeroo
<i>Elaeocarpus reticulatus</i>	Blueberry Ash
<i>Elaeocarpus reticulatus</i>	Blueberry Ash
<i>Enidandra sieberi</i>	Corkwood
<i>Eucalyptus 'Summer Red'</i>	Eucalyptus Summer Red & cultivars
<i>Eucalyptus botryoides</i>	Bangalay
<i>Eucalyptus gummifera</i>	Red Bloodwood
<i>Eucalyptus haemastoma</i>	Scribbly Gum
<i>Eucalyptus obstans</i>	Port Jackson Mallee
<i>Eucalyptus piperita</i>	Sydney Peppermint
<i>Eucalyptus robusta</i>	Swamp Mahogany
<i>Ficus coronata</i>	Sandpaper Fig
<i>Ficus rubiginosa</i>	Port Jackson Fig
<i>Geijera parviflora</i>	Wilga
<i>Gleditsia triacanthos</i>	Honey Locust
<i>Glochidion ferdinandi</i>	Cheese Tree
<i>Hibiscus 'Rubra'</i>	Red-leafed Hibiscus Tree
<i>Hymenosporum flavum</i>	Native Frangipani
<i>Koelreuteria paniculata</i>	Golden Rain Tree
<i>Leptospermum laevigatum</i>	Coastal Tea Tree
<i>Livistona australis</i>	Cabbage Tree Palm
<i>Lophostemon confertus</i>	Brushbox
<i>Magnolia grandiflora</i>	Bull-Bay Magnolia
<i>Melaleuca armillaris</i>	Bracelet Honey Myrtle
<i>Melaleuca decora</i>	White Feather Honey Myrtle
<i>Melaleuca leucadendra</i>	Fine-leafed Paperbark
<i>Melaleuca quinquenervia</i>	Broad-leafed Paperbark
<i>Melaleuca styphelioides</i>	Prickly Paperbark
<i>Melia azederach var. australasica</i>	White Cedar
<i>Metrosideros spp</i>	New Zealand Christmas Bush
<i>Notelaea longifolia</i>	Large Mock-olive
<i>Pittosporum revolutum</i>	Yellow Pittosporum
<i>Podocarpus elatus</i>	Plum Pine
<i>Stenocarpus sinuatus</i>	Firewheel Tree
<i>Sygyium leuhmannii</i>	Riberry
<i>Sygyium paniculatum</i>	Magenta Lilly Pilly
<i>Syncarpia glomulifera ssp glomulifera</i>	Turpentine
<i>Syzygium luehmannii</i>	Riberry
<i>Toona ciliata</i>	Red Cedar
<i>Tristainiopsis laurina</i>	Water Gum
<i>Tristainiopsis laurina</i>	Watergum
<i>Washingtonia robusta</i>	Cotton Palm
<i>Waterhousea floribunda</i>	Waterhousea

## Annexure B5-1 Land Use Risk Categories

Land use is categorised into eight Land Use Risk Categories according to the sensitivity of each type of land use to flooding. The definitions of each land use are based on the Waverley LEP 2012 and are categorised as follows.

**Table 1** Land Use Risk Categories

Category	Examples (not exhaustive, refer to Waverley LEP 2012 for full list).
<b>Critical uses and facilities</b>	Community facilities which may provide an important contribution to the notification or evacuation of the community during flood events (e.g. SES headquarters and Police Stations); hospitals, emergency services; public administration building and residential care facility.
<b>Sensitive Uses and Facilities</b>	Offensive storage establishments; seniors housing; centre-based child care centres; preschools; schools and other educational institutions; correctional centres; liquid fuel depots; public utility undertakings (including electricity generating works; sewerage treatment plant; sewerage systems; telecommunication facilities; utility installations and water treatment facilities) which are essential to evacuation during periods of flood or if affected would unreasonably affect the ability of the community to return to normal activities after flood events; and waste disposal facilities.
<b>Subdivision</b>	Subdivision of land which involves the creation of new allotments with potential for further development.
<b>Residential</b>	Boarding houses; camping or caravan park site; health consulting rooms; home businesses; home industries; home occupation; backpackers accommodation, hotel or motel accommodation; residential accommodation (excluding seniors housing and residential care facilities); serviced apartments; and other development within residential lots including but not limited to construction of garages, swimming pools, and the construction of an outbuilding with a floor area that exceeds 30 m <sup>2</sup> , fencing and/or retaining walls.
<b>Commercial or Industrial</b>	Any business, office or retail premises or buildings or land used for industrial activities.
<b>Tourist Related Development</b>	Camp sites or caravan parks –short–term sites (1) only As defined by the Local Government (Manufactured Home Estates, Caravan Parks, Camping Grounds and Moveable Dwellings) Regulation 2005
<b>Recreation or Non-urban Uses</b>	Agriculture; aquaculture; animal boarding or training establishments; extractive industry; recreation facility (indoor), recreation facility (outdoor); recreation facility (major); recreation areas and minor ancillary structures (e.g. toilet blocks or kiosks); and water recreation structure
<b>Concessional Development</b>	Residential development that involves: <ul style="list-style-type: none"> <li>a. An internal or external alteration to an existing dwelling, which does not change the floor area and/or footprint of the existing dwelling;</li> <li>b. An addition to existing premises of not more than 50 square metres to the existing ground floor level building footprint</li> </ul>

- c. A change of use which does not increase flood risk having regard to property damage and personal safety;
- d. Subdivision which does not propose the creation of new allotments with potential for further development;
- e. The construction of an outbuilding with a floor area of no greater than 30 m<sup>2</sup>.

## Annexure B5-2 Flood Compatible Material

**Table 1** List of suitable flood compatible materials

Building Component				
Flooring and sub-floor	<ul style="list-style-type: none"> <li>Concrete slab-on-ground monolith</li> <li>suspended reinforced concrete slab</li> </ul>			
	Floor covering	<ul style="list-style-type: none"> <li>clay tiles</li> <li>concrete, precast or in situ</li> <li>concrete tiles</li> <li>epoxy, formed-in-place</li> <li>mastic flooring, formed-in-place</li> <li>rubber sheets or tiles with chemicals-set-adhesive</li> <li>silicone floors formed-in-place</li> <li>vinyl sheets or tiles with chemical-set adhesive</li> <li>ceramic tiles, fixed with mortar or chemical-set</li> <li>asphalt tiles, fixed with water resistant adhesive</li> </ul>		
Wall structure		<ul style="list-style-type: none"> <li>Solid brickwork, block work, reinforced, concrete or</li> </ul>		
Roofing structure (for situations where the relevant flood level is		<ul style="list-style-type: none"> <li>reinforced concrete construction</li> <li>galvanised metal construction</li> </ul>		
Doors		<ul style="list-style-type: none"> <li>solid panel with water proof adhesives</li> <li>flush door with marine ply filed with cell foam</li> <li>painting metal construction</li> <li>aluminium or galvanised steel frame</li> </ul>		
		Wall and ceiling linings	<ul style="list-style-type: none"> <li>fibro-cement board</li> <li>brick face or glazed</li> <li>clay tile glazed in waterproof mortar</li> <li>concrete</li> <li>concrete block</li> <li>steel with waterproof applications</li> <li>stone, natural solid or veneer, waterproof grout</li> <li>glass blocks</li> <li>glass</li> <li>plastic sheeting or wall with waterproof adhesive</li> </ul>	
			Insulation windows	<ul style="list-style-type: none"> <li>Foam (closed cell types)</li> <li>Aluminium frame with stainless steel rollers or similar corrosion and water resistant material</li> </ul>
				Nails, bolts, hinges and fittings



<b>Electrical and mechanical equipment</b>	
<i>For dwellings constructed on land to which this DCP applies, the electrical and mechanical materials, equipment and installation must conform to the following requirements:</i>	
<b>Main power supply</b>	Subject to the approval of the relevant authority the incoming main commercial power service equipment, including all metering equipment, must be located above the relevant flood level. Means must be available to easily disconnect the dwelling from the main power supply.
<b>Wiring</b>	All wiring, power outlets, switches, must be to the maximum extent possible, located above the maximum flood level. All electrical wiring installed below this level must be suitable for continuous underwater immersion and must contain no fibrous components. Earth leakage circuit-breaker (core balance relays) or a Residual Current Device must be installed. Only submersible type splices must be used below maximum flood level. All conduits located below the relevant designated flood level must be so installed that they will be self-draining if subjected to flooding.
<b>Equipment</b>	All equipment installed below or partially below the relevant flood level must be capable of disconnection by a single plug and socket assembly.
<b>Reconnection</b>	Should any electrical device and/or part of the wiring be flooded it must be thoroughly cleaned or replaced and checked by an approved electrical contractor before reconnection.
<b>Heating and air conditioning systems</b>	
<i>Where viable, heating and air conditioning systems should be installed in areas and spaces of the house above maximum flood level. When this is not feasible, every precaution must be taken to minimise the damage caused by submersion according to the following guidelines:</i>	
<b>Fuel</b>	Heating systems using gas or oil as fuel must have a manually operated valve located in the fuel supply line to enable fuel cut-off.
<b>Installation</b>	Heating equipment and fuel storage tanks must be mounted on and securely anchored to a foundation pad of sufficient mass to overcome buoyancy and prevent movement that could damage the fuel supply line. All storage tanks must be vented to an elevation of 600 millimetres above the relevant flood level.
<b>Ducting</b>	All ductwork located below the relevant flood level must be provided with openings for drainage and cleaning. Self-draining may be achieved by constructing the ductwork on a suitable grade. Where ductwork must pass through a water-tight wall or floor below the relevant flood level, a closure assemble operated from above relevant flood level must protect the ductwork.

*Note: The above list is not considered to be exhaustive and other materials and methods can be proposed for Council's consideration as part of any application.*

---

**Annexure B5-3**  
**Flood Impact Assessment Requirements**

A Flood Impact Assessment (FIA) must be prepared by a professional engineer who specialises in hydraulic engineering. The FIA must be prepared in accordance with the relevant sections of this Chapter. The 20% AEP, 1% AEP and PMF flood events must be modelled to assess the impact on existing flood conditions of a proposed development to property, infrastructure and the environment. A FIA may be required for any type of development where the development occurs in the floodplain (i.e. situated within the Flood Planning Area). A FIA may also be required where the site in question is tagged as a Flood Control Lot as defined in the State Environmental Planning Policy (Exempt and Complying Development Codes State Environmental Planning Policy) for the purposes of the application of the State Environmental Planning Policy.

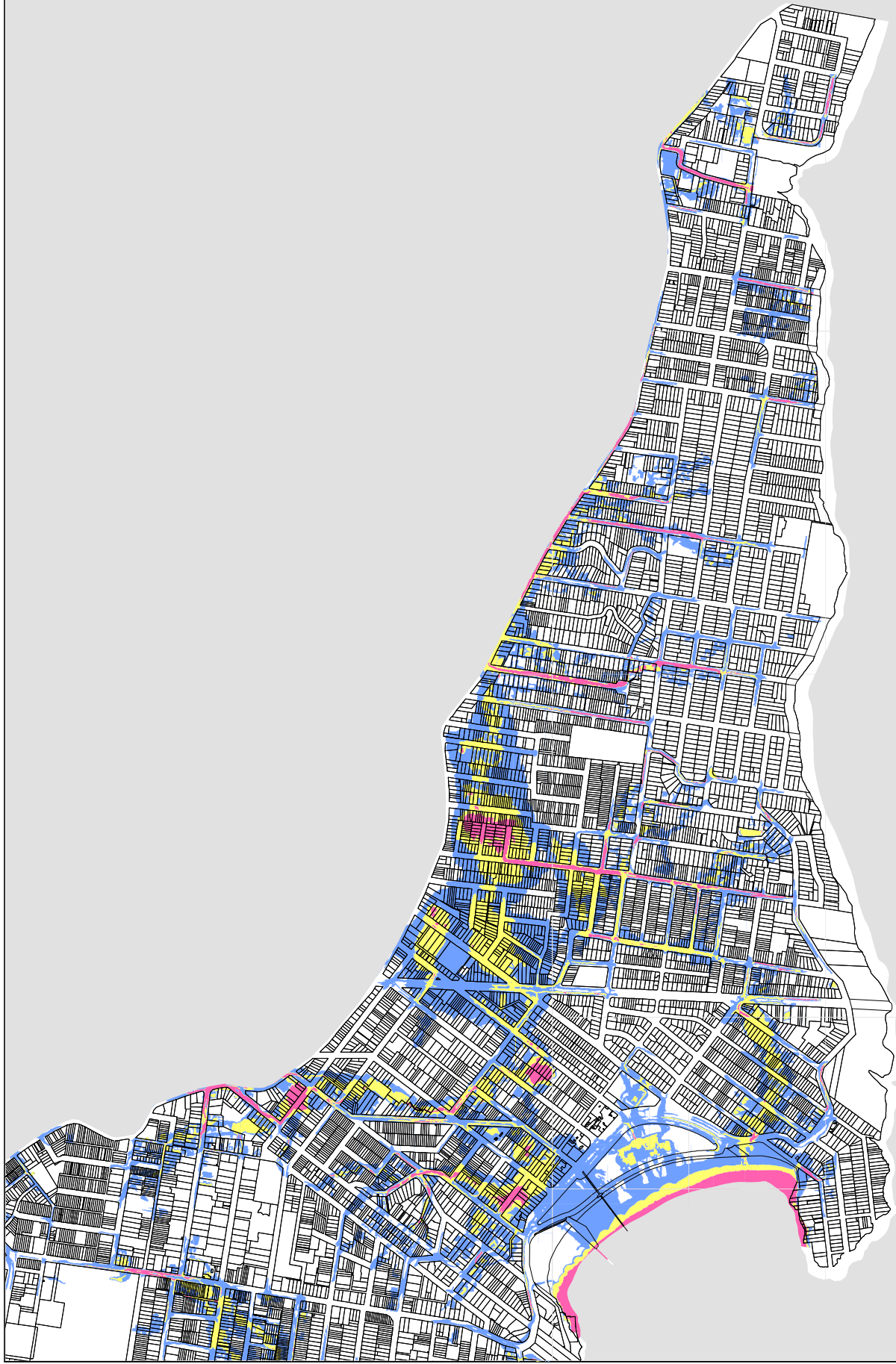
Unless it can be demonstrated that hydraulic modelling is not required, the FIA must be prepared using Council's TUFLOW model (note: a fee is payable for the TUFLOW model). Once engaged, the consultant must enter into a license agreement for the use of Council's flood model for the specific purpose of preparing the FA for the proposed development only

The FIA must address the following:

- Description of the Site (including existing stormwater drainage and local catchment characteristics) and details of the proposed development.
- Flood affectation to the Site during the 5% AEP, 1% AEP and PMF events under existing (i.e. pre-development) conditions.
- Overview of the Flood Risk Precinct and associated development controls applicable to the Site
- Flood affectation to the Site during the 5% AEP, 1% AEP and PMF events under post-development conditions.
- Overview of the change in flood conditions associated with the proposed development.
- Discussion of adherence to applicable planning controls.
- Proposed mitigation measures to address any impacts or minimise risk to personal safety of occupants and the risk of property damage.
- A flood evacuation strategy (Flood Emergency Response Plan) (if required).
- On site response plan to minimise flood damage and provide adequate storage areas for hazardous materials and valuable goods above the flood level (if required).
- The architectural/engineering plans on which the assessment is based.
- Supporting calculations and mapping.
- The professional qualifications and experience of the author(s).

---

**Annexure B5-4**  
**Flood Planning Area**



### Flood Planning Area



#### Flood Risk Precincts

- Low
- Medium
- High

#### Cadastral

Cadastral FRP  
06/04/2023

**Disclaimer:**  
 This map is presented by Waverley Council for the purpose of disseminating information for the benefit of the public. No statement is made about the accuracy or suitability of the information for use for any purpose (whether the purpose has been notified to Council or not). While every care is taken to ensure the accuracy of this data, neither the Waverley Council nor the NSW Spatial Services makes any representations or warranties about its accuracy, reliability, completeness or suitability for any particular purpose and disclaims all responsibility and all liability (including without limitation, liability in negligence) for all expenses, losses, damages (including indirect or consequential damage) and costs which you might incur as a result of the data being inaccurate or incomplete in any way and for any reason.  
 Contact: [gis@waverley.nsw.gov.au](mailto:gis@waverley.nsw.gov.au)



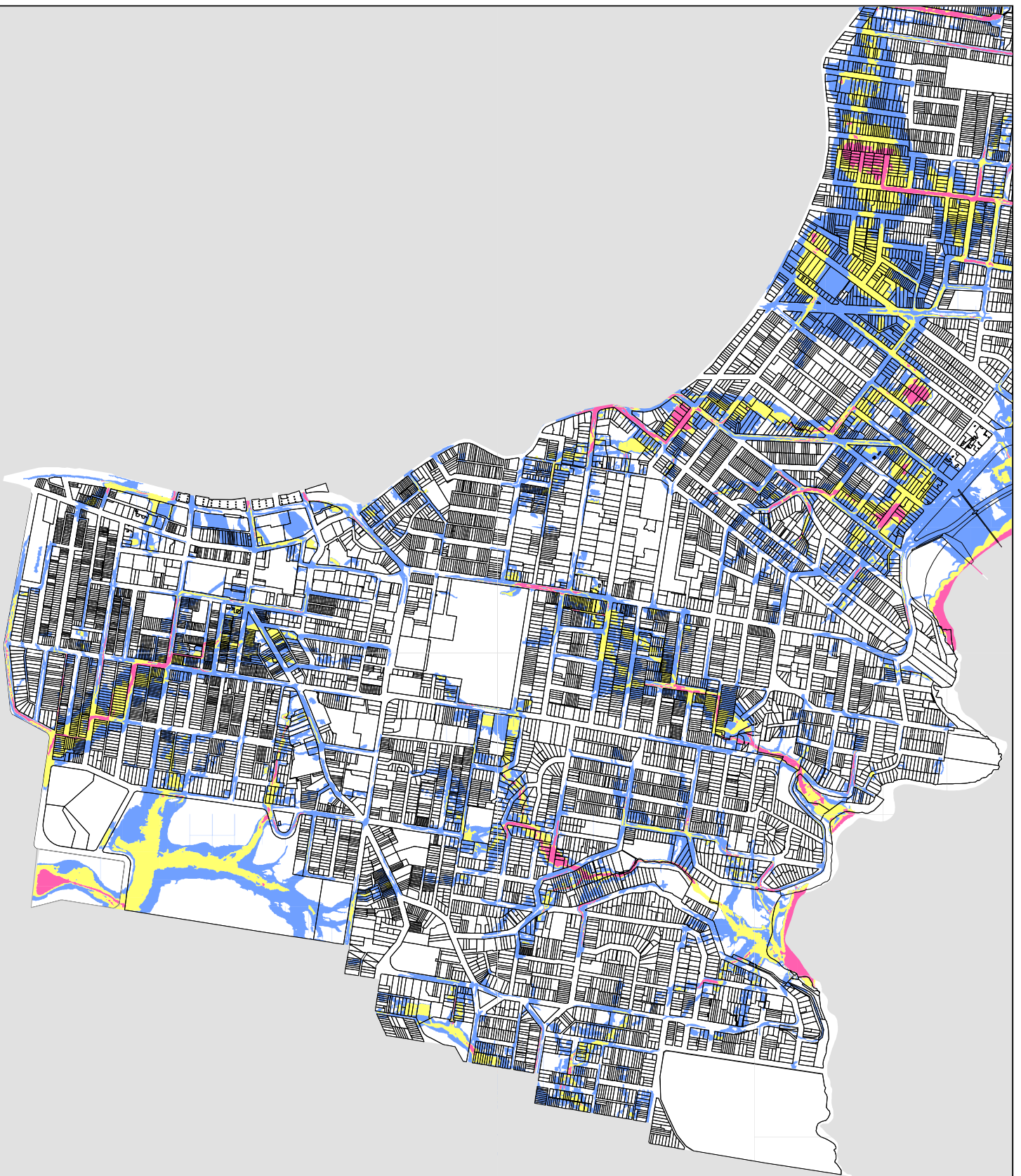
Projection: GDA 2020  
MGA Zone 56



Scale: 1:12,770 @ A3

Author: eSolutions  
Date created: 17/01/2024





## Flood Planning Area



### Flood Risk Precincts

- Low
- Medium
- High

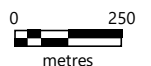
### Cadastral

Cadastral FRP  
06/04/2023

**Disclaimer:**  
 This map is presented by Waverley Council for the purpose of disseminating information for the benefit of the public. No statement is made about the accuracy or suitability of the information for use for any purpose (whether the purpose has been notified to Council or not). While every care is taken to ensure the accuracy of this data, neither the Waverley Council nor the NSW Spatial Services makes any representations or warranties about its accuracy, reliability, completeness or suitability for any particular purpose and disclaims all responsibility and all liability (including without limitation, liability in negligence) for all expenses, losses, damages (including indirect or consequential damage) and costs which you might incur as a result of the data being inaccurate or incomplete in any way and for any reason.  
 Contact: [gis@waverley.nsw.gov.au](mailto:gis@waverley.nsw.gov.au)



Projection: GDA 2020  
MGA Zone 56

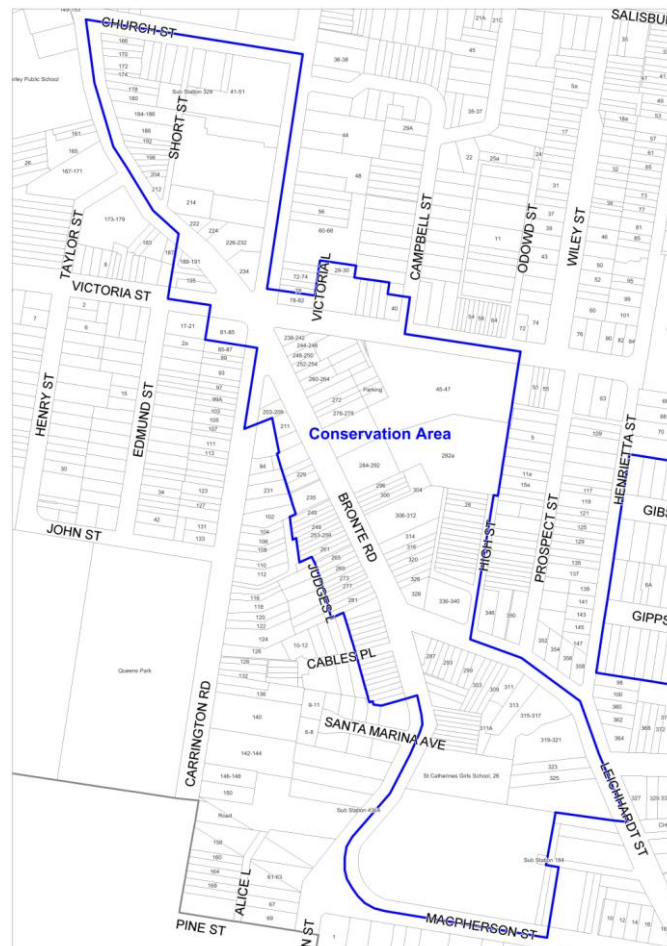


Scale: 1:12,770 @ A3

Author: eSolutions  
Date created: 17/01/2024

**Annexure B8-1****Charing Cross Conservation Area**

The following map highlights the study area, as well as an extract of the Charing Cross heritage conservation area (refer to Figure 37).



**Figure 37** Charing Cross heritage conservation area

The following provides recommendations for future conservation opportunities as well as appropriate colour schemes for the identified properties or property groups. Furthermore, the Charing Cross Streetscape Study provides a physical description of every building or building group within the study area and general recommendations for the overall improvement of the streetscape. All of the buildings included in the study are located in the Charing Cross heritage conservation area.

**Conservation of Original Fabric**

A large amount of original fabric still exists in the street facades of the conservation area, particularly in the upper wall areas above the awnings. However, much of it has been compromised by later additions or is covered by unsympathetic paint schemes. It is recommended that each period of building be respected for its individual contribution to the development of the area and that future treatment will be consistent with the original character of the building.

Original shopfronts are becoming increasingly rare and remaining examples should be conserved. Partial or missing examples of original fabric can be restored or reconstructed to aid interpretation and appreciation of the streetscape, however, this must be done with care and be based on evidence, thorough research and inspection of the physical evidence on site by an experienced conservation architect.

### Colour Schemes

Cleaning and repainting the facades of the buildings in the study area would be an improvement to the presentation of the street. Many individual buildings have unsympathetic colour schemes that are inconsistent with the style of the building and with the grouping in which they were built. It is desirable that the colour scheme of each building or group of buildings be informed by the period in which it was built and by physical investigation of the early paint layers on the exterior fabric. A conservation architect or heritage practitioner could carry out paint scrapes to determine the early colours. These colours could then be interpreted in a colour scheme that suits the current owners or tenants. Correct tonal relationships (the use of light and dark colours on various elements) are more important than exact replication of hues.

The accompanying inventory sheets for each building or group of buildings contain recommended colour schemes which are based on the period, style, and current treatment of the buildings. For example, in some cases where original face brickwork has been painted over, the colour scheme provides a recommendation to paint the brickwork brown to simulate face brick. These recommended colour schemes are speculative, relying on knowledge of original colour schemes of other buildings of similar periods, and are not based on physical intervention. It is preferable to undertake paint scrapes to determine the original colour scheme of each building, however, if this is not possible, the recommended colour schemes would result in a more historically relevant appearance of the streetscape.

Colour terms used in the inventory sheets relate to the Australian Standard 2700 - Colour Standards for General Purposes as follows:

Colour name	AS2700 colour name	AS2700 code
Biscuit	Raffia	X31
Bridge grey	Light grey	N35
Bronze green	Deep bronze green	G63
Brown (to simulate brickwork)	N/A – approve by sample	
Buff	Oatmeal	Y54
Copper beech	Dark brown	X65
Cream	Sandstone	Y53
Crimson	Maroon	R65
Deep Brunswick green	Bottle green	G11
Eau-de-Nil	Palm green	G44
Forest green	Holly	G12
French grey	Storm grey	N42
Grey green	Banksia	G53
Indian red	Deep indian red	R64
Manilla	Manilla	Y45
Mid-brown	Brown	X54
Mountain blue	Blue jay	T24
Off-white	Off-white	Y35

Colour name	AS2700 colour name	AS2700 code
Olive	Mist green	G54
Pale grey (to simulate render)	N/A – approve by sample	
Pink brown	Cinnamon	X45
Sea green	Lichen	G55
Vellum	Surf green	G43
Venetian red	Venetian red	R62
White	N/A	N/A

#### Recommended Finishes

All render and plaster should have a semi-gloss finish. All timber and metalwork should have a gloss finish.



**Annexure B8-2**

*Queens Park Conservation Area*

The Queens Park Conservation Area (QPCA) has been identified as an area that has unique physical qualities and an intrinsic residential character that should be preserved (refer to Figure 38). Any property within the QPCA must have regard for the Desired Future Character as outlined in Annexure B8-2 and adhere to the Objectives and Controls within Part B8.



**Figure 38** Queens Park Conservation Area

### Subdivision

Streets in the area are arranged in a grid pattern with most blocks containing internal rear service lanes. The subdivision pattern features three categories of lot size, reflecting the type of dwellings in the area. Small sized lots (typically 100m<sup>2</sup> to 250m<sup>2</sup>) dominate the north-eastern portion of the study area. These lots typically contain Victorian terraces and other attached dwelling styles (refer to Figure 39).

*Queens Park Heritage Conservation Area*



**Figure 39** Example of Victoria terraces in the area

In the central and southern part of the area, lots tend to be larger (typically 200m<sup>2</sup> to 400m<sup>2</sup>) reflecting the semi-detached and detached villa dwelling typology (refer to Figure 40).



**Figure 40** Example of semi-detached dwellings in the area

The largest lots (500m<sup>2</sup> to 800m<sup>2</sup>) are present on the western and southern edges of the area, fronting onto Queens Park Road and York Road. These lots contain bungalow style dwellings with a large front set back, and a small number of residential flat buildings (refer to Figure 41).

### Views and Vistas

North-south street axes provide important view corridors to Queens Park. Formal tree plantings in these streets frame views to the open parkland in the distance. Properties in the upper eastern portion of the area enjoy distant views of parklands and the city to the west.



**Figure 41** Example of the detached bungalow dwelling style in the area

### Open Space

Queens Park and Centennial Park are expansive areas of open space bordering the character area to the south and west respectively. These parklands are significant landmarks and provide a contrast to the compact residential character of the area.

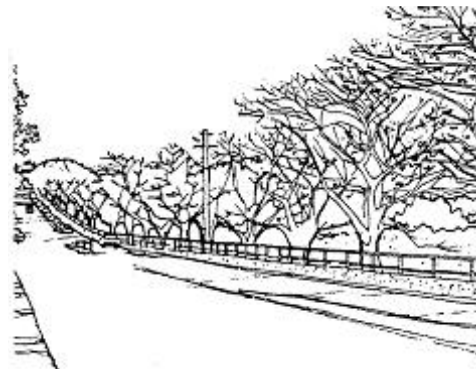
### Landscaping

Vegetation is an important element to the character of this area. Formal plantings of mature fig trees are the most distinguishing characteristic of the inner residential streets and provide a uniting theme throughout the study area. The sense of enclosure created by the avenues of mature trees is in contrast to the openness of the parkland bordering the area to the south and west (refer to Figure 42).

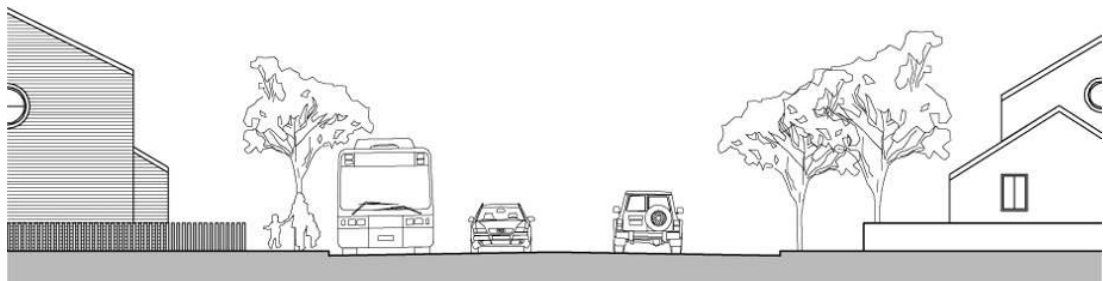
### Residential Character – Streetscapes

Three distinct types of streetscape character are found within the area. Streets which carry larger volumes of local through traffic (e.g. Birrell Street, Queens Park Road, York Road), inner residential streets (e.g. Manning Street, Alt Street, Ashton Street) and rear access lanes.

The streets with higher volumes of through traffic have a wider carriageway, relatively narrow verges and smaller scale and less dense street plantings. These features contribute to a wider, more open streetscape (refer to Figure 43).

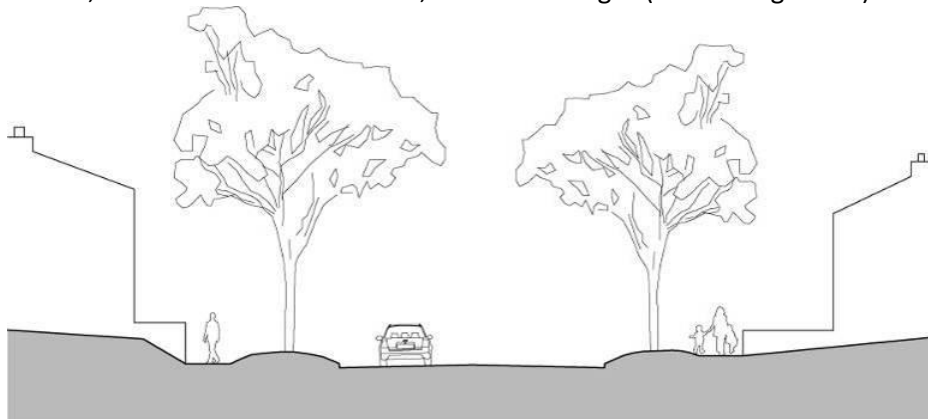


**Figure 42** Open views, established street trees and rock outcrops are a unique character of Queens Park



**Figure 43** Typical section of a street with high volumes of through traffic

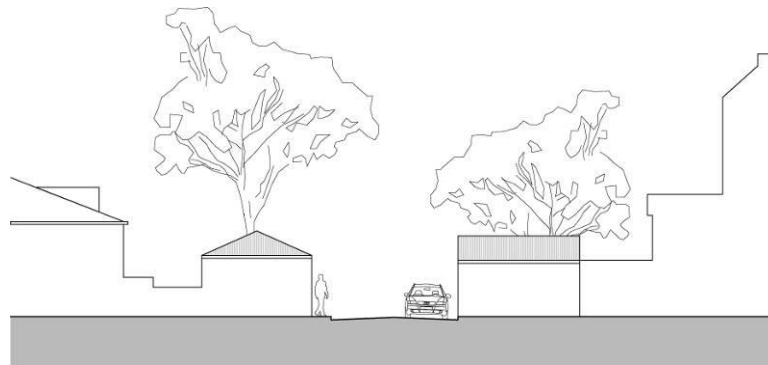
Inner residential streets are characterized by mature trees forming a canopy. These streets are foliage shaded, with a cooler microclimate, and wider verges (refer to Figure 44).



**Figure 44** Typical section of an inner residential street

The narrow, corridor like rear access lanes are dominated by garage doors, high fences, walls, landscape screening, and a variety of building setbacks (refer to Figure 45). A variety of front fence styles and setback conditions typify the range of dwelling styles represented in the area. Shallow front setbacks with cast iron front fences are part of the original character of Victorian terraces. While most remain intact, some have been replaced with higher, rendered brick fences. Detached and semi-detached dwellings typically have deeper front setbacks, with low brick or timber picket front fences being the most common styles (refer to Figure 46).

Low, stepped brick fences are used on steeper sites and where no rear lane access is provided, garage doors and sloped landscaping face the street (refer to Figure 47).



**Figure 45** Typical section of a rear access lane.

### Architectural Style

QPCA is one of the oldest precincts in the Municipality, containing many manmade and natural heritage items, including remnants of walls, stables, buildings, caves and trees. Any development must be sensitive to these items.

A variety of architectural styles reflect the various eras of development in the study area. These include the Victorian Terrace, sandstone Post Regency cottage, Victorian Gothic, Edwardian and Federation semidetached dwellings and larger Federation, Californian and Modern bungalows. Most dwellings are clustered in groups of similar style. Repetition of building elements such as shingled gables, chimneys, doors and windows, terraces, entrances, fences, etc. establishes a coherent streetscape character based on detail and rhythm.

Recent development has increased the vocabulary of the character of the area. New dwellings and alterations and additions range from minor dormer windows to contemporary architecture.



**Figure 46** Example of low and transparent fences which correspond to the established existing character elements.



**Figure 47** Stepped fences on steeper sites

# PART C RESIDENTIAL DEVELOPMENT

## Contents

<b>GENERAL NOTES.....</b>	<b>181</b>
<b>C1 LOW DENSITY RESIDENTIAL DEVELOPMENT .....</b>	<b>182</b>
1.0 General Objectives .....	183
1.1 Height .....	184
1.2 Setbacks.....	186
1.3 Streetscape and Visual Impact .....	189
1.4 Fences .....	190
1.5 Visual and Acoustic Privacy .....	192
1.6 Solar Access .....	194
1.7 Views.....	195
1.8 Car Parking.....	196
1.9 Landscaping and Open Space .....	200
1.10 Swimming Pools and Spa Pools .....	201
1.11 Dormer Windows.....	202
1.12 Battle Axe Blocks .....	203
1.13 Semi-detached Dwellings & Terrace Style Development .....	204
1.14 Dual Frontage Development.....	207
1.15 Dual Occupancy Development .....	211
1.16 Secondary Dwellings and Ancillary Buildings .....	212
<b>C2 OTHER RESIDENTIAL DEVELOPMENT .....</b>	<b>214</b>
2.1 Site, Scale and Frontage .....	216
2.2 Height .....	217
2.3 Setbacks.....	220
2.4 Length and Depth of Buildings.....	222
2.5 Building Design and Streetscape .....	223
2.6 Attic and Roof Design .....	224
2.7 Fences and Walls .....	226
2.8 Pedestrian Access and Entry.....	227
2.9 Landscaping .....	228
2.10 Communal Space .....	229
2.11 Private Open Space.....	230
2.12 Vehicular Access and Parking .....	232
2.13 Solar Access and Overshadowing .....	233
2.14 Views and View Sharing.....	234
2.15 Visual Privacy and Security .....	236
2.16 Dwelling Size and Layout .....	238
2.17 Ceiling Heights .....	239
2.18 Storage.....	240
2.19 Acoustic Privacy .....	241
2.20 Natural Ventilation .....	242
2.21 Building Services .....	243
2.22 Retention of Affordable Rental Housing.....	244



## GENERAL NOTES

A number of provisions within *Part C Residential Development* refer to the Planning Principles based on cases from the NSW Land & Environment Court. More information on Planning Principles and the respective cases can be found at:

[http://www.lec.justice.nsw.gov.au/Pages/practice\\_procedure/principles/planning\\_principles.aspx](http://www.lec.justice.nsw.gov.au/Pages/practice_procedure/principles/planning_principles.aspx)

### State Legislation Affecting Residential Development

The controls within this Part should be read in conjunction with *State Environmental Planning Policy (Exempt and Complying Development Codes) 2008* (Codes SEPP) and the *Waverley Local Environmental Plan (WLEP)*, which define what can be carried out as exempt or complying development and override these controls.

*Low Rise Medium Density Housing Code* – the Department of Planning & Environment has prepared legislation and a Low Rise Medium Density Design Guide for Development Applications. For the purposes of the Low Rise Medium Density Housing Code, Part C3 of this DCP applies.

*State Environmental Planning Policy (Housing) 2021* and the associated *Apartment Design Guide (ADG)* aim to improve the design quality of residential apartment development. The policy applies to the residential components of residential flat building, shop top housing and mixed-use developments that are three or more storeys, and contain four or more dwellings.

### Inter-War Buildings

Part B16 Inter-War Buildings applies to all Inter-War buildings and is to be read in conjunction with this Part and the *Waverley Inter-War Building Design Guidelines*.

An Inter-War building is a building constructed in the period from c.1914 to c.1940. In a case of contention as to whether Part B17 should apply to a development, the burden of proof is on the applicant to demonstrate that a building is not an Inter-War building.

### Special Character Areas

Refer to Part E4 for Special Character Areas which may apply to certain residential properties.

**C1 LOW DENSITY RESIDENTIAL DEVELOPMENT**

This Part applies to any type of low density residential development proposing a new building or alterations and additions to an existing building or buildings in the Waverley LGA. For the purposes of *Part C1 Low Density Residential Development* the term lower density residential accommodation includes the following types of development:

- Dwelling house;
- Dual occupancy;
- Semi-detached dwelling;
- Attached dwelling (terrace styled development); and
- Secondary dwelling.

Each type of lower density residential accommodation is defined in the WLEP.

Development is to comply with the provisions of this part, as well as all other relevant parts of the WDCP. Parts C1.1 – C1.12 are general controls, and Parts C1.13 – C1.16 of this Part apply to specific development types, in addition to the general controls.

**GENERAL NOTES.....181**

**C1 LOW DENSITY RESIDENTIAL DEVELOPMENT .....182**

1.0	General Objectives .....	183
1.1	Height .....	184
1.2	Setbacks.....	186
1.3	Streetscape and Visual Impact .....	189
1.4	Fences .....	190
1.5	Visual and Acoustic Privacy .....	192
1.6	Solar Access .....	194
1.7	Views.....	195
1.8	Car Parking.....	196
1.9	Landscaping and Open Space .....	200
1.10	Swimming Pools and Spa Pools .....	201
1.11	Dormer Windows.....	202
1.12	Battle Axe Blocks .....	203
1.13	Semi-detached Dwellings & Terrace Style Development .....	204
1.14	Dual Frontage Development.....	207
1.15	Dual Occupancy Development .....	211
1.16	Secondary Dwellings and Ancillary Buildings .....	212

**1.0 GENERAL OBJECTIVES**

- (a) To ensure that the scale of lower density residential accommodation is appropriate for allotment sizes and other dwellings in the vicinity.
- (b) To ensure that lower density residential accommodation does not significantly detract from the amenity, privacy and views of other dwellings and public view corridors.
- (c) To ensure that the consent authority has regard to the principles of ecologically sustainable development when assessing applications.
- (d) To ensure that new development and alterations and additions to existing lower density residential accommodation is sympathetic in bulk, scale and character with the desired future character of the area.
- (e) To encourage lower density residential accommodation to have high design standards and are built in accordance with the objectives and controls of this Part.



## 1.1 HEIGHT

The WLEP outlines the maximum permissible building height of a site. Achieving the maximum building height may not be appropriate in all cases and should not be considered as prescribed or allowable regardless of circumstance. Amenity or streetscape impacts may require a lower height or additional setbacks. Nothing in this part restricts Council's ability to require the height of a building to be less than the maximum height as specified in the LEP.

### Objectives

- (a) To provide appropriate building heights for flat or pitched roof forms for lower density residential accommodation.
- (b) To ensure the height and scale of development relates to the topography and street character.
- (c) To ensure the height and scale of development does not unreasonably impact on views enjoyed by neighbouring and nearby properties.
- (d) To ensure that the height and scale of development does not result in unreasonable overshadowing of neighbouring and nearby properties.
- (e) To minimise loss of views from, and overshadowing of, public places.
- (f) To ensure development in excavation areas does not add to the overall visual bulk of the dwelling.

### Controls

- (a) For a building with a pitched roof the maximum wall height is 7m above existing ground level (refer to Figures 4 and 5), except as determined in Control (b) below.
- (b) For a building with a flat roof, the maximum wall height is 7.5m above existing ground level.
- (c) Where it is permissible for buildings to be built to a height greater than 9.5m under WLEP, the wall height will be determined by a merit assessment of the design of the building and its relationship to adjoining dwellings.
- (d) Buildings on steep sites are to be stepped down to avoid high columns, elevated platforms and large undercroft areas.

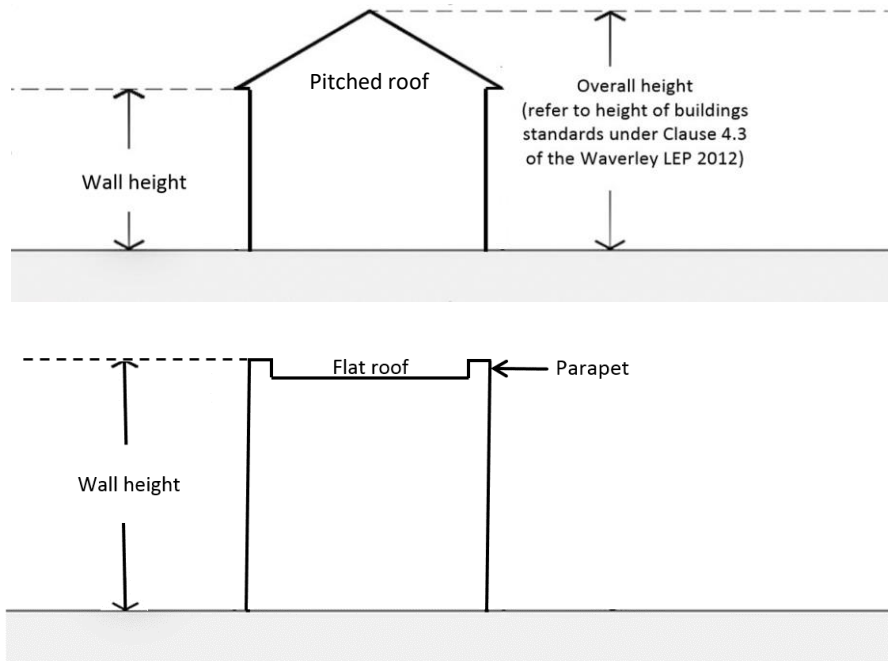


Figure 4 How to measure wall height for dwellings with pitched and flat roofs

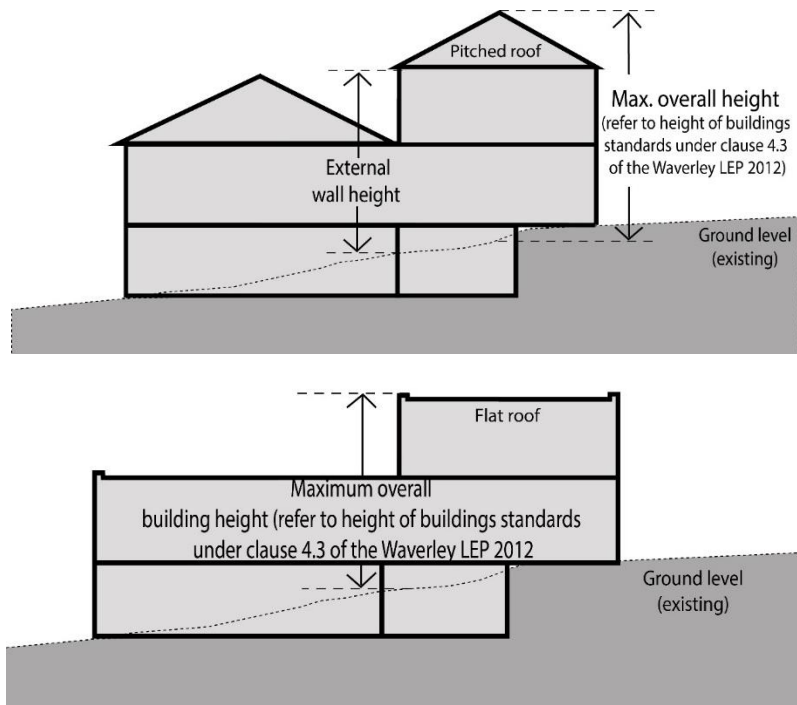


Figure 5 How to calculate height on sloping land

Note: The maximum building height (LEP) is calculated from the basement floor for sites with an existing basement. The maximum external wall height only includes the portion of wall above ground.

## 1.2 SETBACKS

### Objectives

- (a) To ensure that the bulk and appearance of the proposed development is appropriate to the streetscape.
- (b) To set a rhythm and character to residential streets.
- (c) To ensure the distance between buildings on adjacent properties allows adequate solar access, ventilation and privacy.
- (d) To ensure that the amenity of rear yards, their function as private open space, and their visual and landscape contribution to the surrounding area is protected and enhanced.
- (e) To accommodate flexibility in the siting of buildings, where appropriate.
- (f) To ensure the front and rear setbacks of buildings are consistent with surrounding buildings and do not visually detract from the streetscape.
- (g) To ensure significant views and view corridors available from the public domain and existing properties are considered as part of the local context of any development. Refer to *Part C1.10 Views*.
- (h) To ensure buildings on corner lots are consistent with the predominant building lines of adjoining sites.

### Controls

#### 1.2.1 Front and rear building lines

- (a) New buildings and extensions to existing buildings are to extend no further than the front and rear predominant building lines (refer to Figures 6 and 7). The predominant building line can be considered to be the three adjacent neighbours on either side.
- (b) The predominant rear building line is determined separately for each floor level. Notwithstanding (a) above, development at first floor level and above shall be set back from the rear building line of the ground floor level in order to minimise bulk and scale impacts and provide visual relief for the open space and living areas at adjacent properties (refer to Figure 6).
- (c) The siting of dwellings on corner lots should take reference from the setbacks of dwellings on adjacent sites.
- (d) Where it is proposed to build beyond the predominant front and/or rear building line at any level, or where there is no predominant front and/or rear building line, or where it is not possible to setback from the rear building line at first floor level, then greater consideration must be given to the following;
  - (i) Compliance with applicable development standards, including Floor Space Ratio and Building Height;
  - (ii) Compliance with the landscaped and open space controls;
  - (iii) Compliance with side setback controls;
  - (iv) Emergence of a new front and/or rear building alignment beyond the dwellings either side of the subject site (note that any reliance on an emerging front and/or rear building alignment as a precedent can only be justified where the emerging alignment is itself based on compliant development with respect to building height, FSR and side setback controls);
  - (v) Location and retention of existing significant vegetation;

- (vi) Visual aspect of the bulk and scale as viewed from the private open space and living areas of adjoining properties;
- (vii) Acceptability of amenity impacts on adjacent properties with regard to solar access, and visual and acoustic privacy;
- (viii) Views available from the subject site and adjoining properties including an assessment against the Land and Environment Court Views Planning Principle in *Tenacity Consulting v Warringah Council [2004] NSWLEC 140 at 25-29*;
- (ix) In areas of heritage significance, the importance of preserving the front portion of the building by providing an additional setback from the front building line.

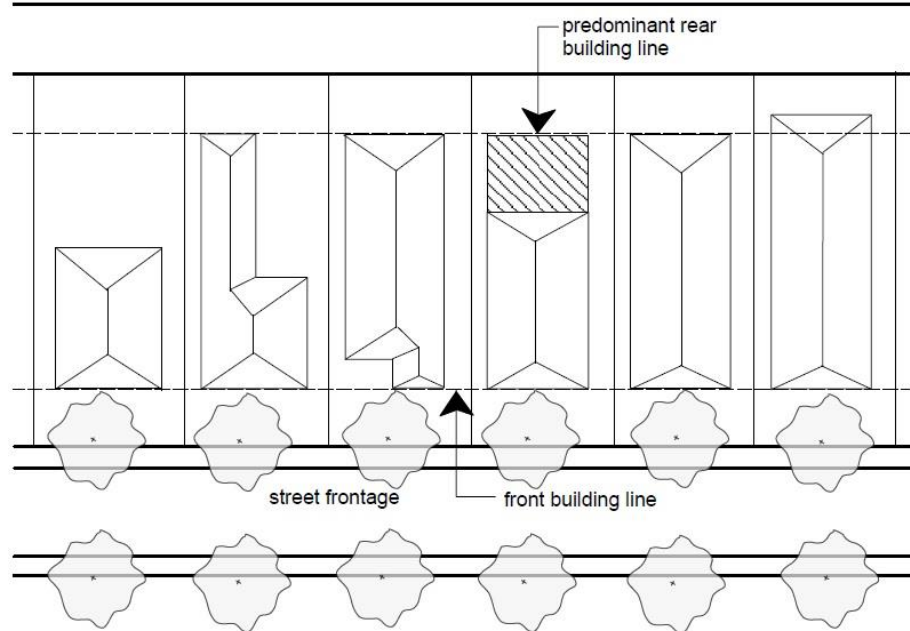


Figure 6 Example of front and rear predominant building lines on regular shaped lots

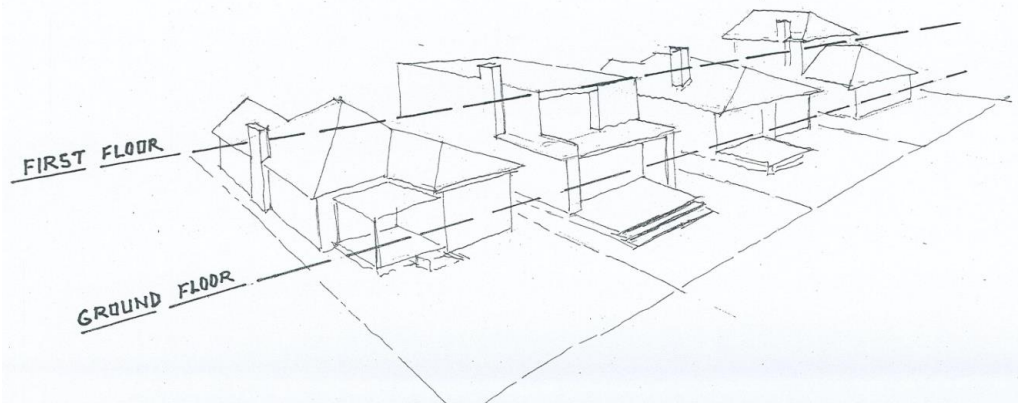


Figure 7 Example of ground and first floor level predominant rear building lines

**1.2.2 Side Setbacks**

- (a) Comply with the minimum setbacks as follows:

Location of proposed works	Side setback (min.)
Ground Floor	0.9m
First Floor	0.9m
Second Floor	1.5m

Third Floor	On merit
-------------	----------

Table 1 Minimum side setbacks

**Note:**

- The side setbacks may be reduced if the proposed dwelling or alteration adjoins another dwelling without a setback along the shared boundary. This applies only to that section of the boundary which the neighbouring dwelling is built. The ‘ground floor’ is considered the lowest floor on site when considering which side setback floor to apply.
- Greater side setbacks may be required to achieve compliance with Parts C1.3, C1.5, C1.6, C1.7 and C1.9 of this DCP.
- Side setbacks for components of existing buildings being retained do not need to be changed to comply with Table 1, however, new works proposed to an existing building do need to be changed to comply.
- Where a brand new three storey structure is proposed, all floors must be setback by 1.5m.

### 1.3 STREETScape AND VISUAL IMPACT

#### Objectives

- (a) To enhance the built form by encouraging quality design that corresponds harmoniously with the surroundings.
- (b) To encourage and facilitate lower density residential accommodation of a high architectural and aesthetic standard, that acknowledges and responds to the architectural style, scale, materials and character of the existing built environment.
- (c) To ensure development provides a clear distinction between private and public space and encourages casual surveillance of the street.
- (d) To ensure views to and from a public place including parks, reserves, beach or the ocean are preserved.

#### Controls

- (a) New development should be visually compatible with its streetscape context. It should contain or at least respond to essential elements that make up the character of the surrounding area.
- (b) When replacing existing windows, the style is to complement the style and proportions of the existing dwelling when viewed from the street.
- (c) Contemporary alterations and additions should include windows characteristic of the style of the addition.
- (d) Development must not dominate or erode the character of the streetscape, particularly when viewed from a public place such as parks, reserves, beach or the ocean.
- (e) New development as well as alterations and additions to existing dwellings are to maintain the established character of the building in terms of significant landscaping. Existing ground levels and significant landscaping is to be maintained.
- (f) Existing verandahs and balconies fronting the street are not to be enclosed.
- (g) Porticos above a fence or entrance way are to minimise bulk and are only appropriate where it can be demonstrated that they are consistent with the existing street character.
- (h) The maximum volume permitted for a plant room is the minimum required to meet Australian Standards, accommodate typical dimensions of equipment required and the associated circulation space to access the equipment for maintenance. DA plans should show the approximate location and size of equipment within the plant room.

## 1.4 FENCES

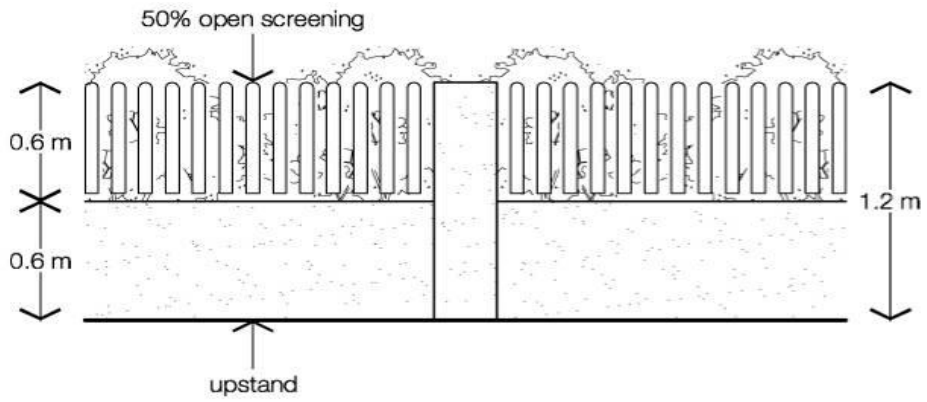
### Objectives

- (a) To ensure that fences relate to the period and architectural style of buildings on the site and in the vicinity.
- (b) To avoid adverse visual impacts from the creation of high blank walls to the street.
- (c) To promote a streetscape where the ground floor front facades of dwellings are visible from the street.
- (d) To ensure front fences and entrance porticos do not dominate the streetscape, and that they are cohesive with the character of the streetscape.
- (e) To ensure that side and rear fences are not excessive in height, resulting in adverse impacts on adjoining properties.
- (f) To ensure boundary treatments of properties adjoining parks are consistent with the materials palette in the relevant Plan of Management to maintain the amenity of parks.

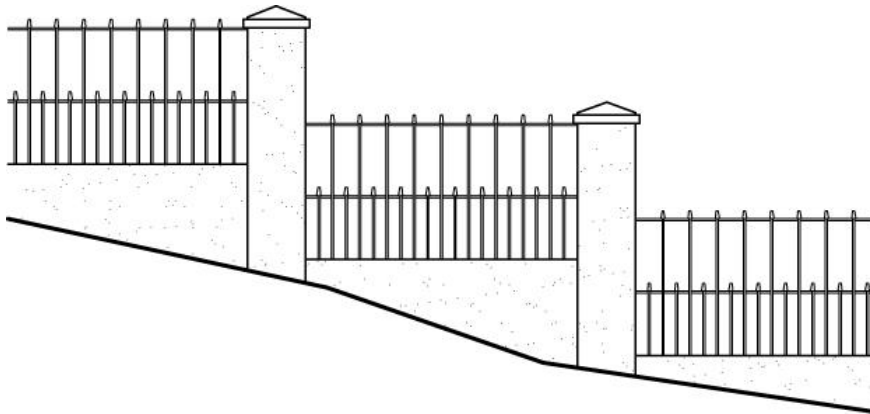
### Controls

- (a) The design of front fences is to take reference from, and complement, the architectural style of the dwelling on the site and dwellings on adjacent sites in terms of style, height and materials.
- (b) Front fences should generally not exceed 1.2m in height. Any solid upstand section should be limited to 600mm in height. The top half of the fence should be an open design with a minimum open area of 50%, for visibility to and from the site (refer to Figure 8). Components such as arched gates, piers and the like may exceed the predominant 1.2m height.
- (c) On sloping sites, the height limit is averaged so that the fence steps down the slope (refer to Figure 9).
- (d) Side and rear boundary fences are not to exceed 1.8m above the existing ground level of adjoining properties and are to taper down from the front building line to match the height of the front fence at the front boundary (refer to Figure 10).
- (e) Council may permit front fences up to a height of 1.8m and/or of solid material provided it can be shown that the fence acts as an effective noise barrier as a result of adjoining a street with high traffic volume. Such fences are to be setback from the boundary to allow landscaping to soften the bulk or the structure is to be articulated as an alternative to a solid blank wall.
- (f) Where there is dual street frontage, consideration may be given for the allowance of a higher side fence to ensure privacy.
- (g) All boundary treatments for properties adjoining public parks are consistent with materials palette from the relevant Plan of Management.
- (h) New brickwork increasing the height of brick fences should match the existing wall.
- (i) Decoration and/or architectural relief shall be provided to masonry fences, avoiding expansive blank walls facing the street.
- (j) No part of a fence, including its footings, is to encroach on the street alignment or adjoining properties.
- (k) Gates are not to open into the street alignment or adjoining public parks.

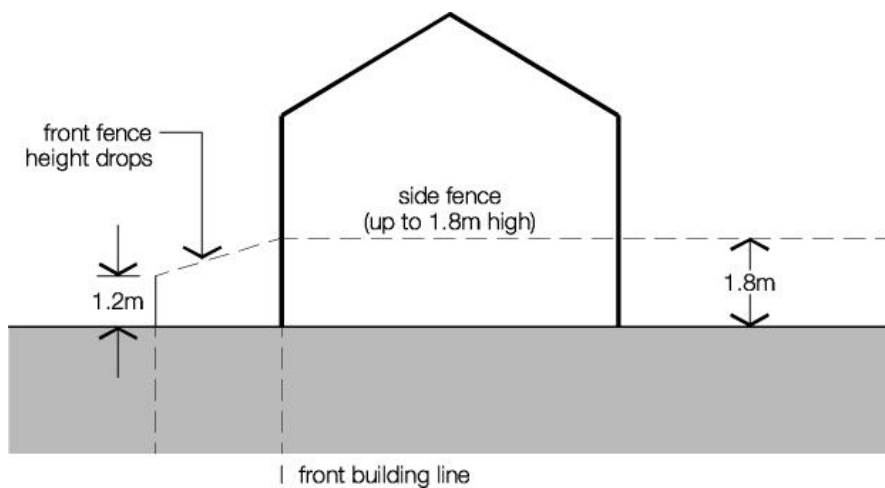
- (l) All fence controls are subject to the provision of adequate sight lines for emerging vehicles to enable surveillance of pedestrians using the footpath in front of a dwelling.
- (m) A setback is to be provided for pedestrian entry gates.



**Figure 8** Example of front fence with maximum solid up stand of 600mm and open design top section



**Figure 9** Fence height limit is averaged on sloping sites



**Figure 10** Side fences should taper down from the front building line.



## 1.5 VISUAL AND ACOUSTIC PRIVACY

### Objectives

- (a) To ensure that development does not unreasonably impact upon existing residential or other properties due to unacceptable loss of privacy or generation of noise.
- (b) To minimise the impact of roof terraces on adjoining properties.
- (c) To ensure that development provides residents with a reasonable level of acoustic and visual privacy.
- (d) To minimise the provision of roof terraces where it is uncharacteristic of the area.

### Controls

- (a) Development is to consider the Privacy Planning Principle in *Super Studio v Waverley Council [2004] NSWLEC 91* at 5-7.
- (b) Windows to habitable rooms are not to directly face windows to habitable rooms and / or open space of neighbouring dwellings unless direct views are screened or other appropriate measures are incorporated into the design.
- (c) In order to protect the visual and acoustic privacy of adjoining properties and to maintain an appropriate aesthetic quality of development, external stairs are not acceptable.
- (d) Where an elevated courtyard, balcony, terrace or deck is visually prominent from, or in close proximity to, a neighbouring dwelling, permanent screening, landscaping and vegetation is to be used in combination to minimise any impacts to an acceptable level.
- (e) Where an elevated deck or balcony is proposed it should have a maximum area of 10m<sup>2</sup> and a maximum depth of 1.5m. Where a larger area is proposed then greater consideration must be given to the following:
  - (i) Compliance with the building height development standard;
  - (ii) Compliance with setback controls;
  - (iii) Efforts to mitigate visual and acoustic privacy impacts including the use of permanent screening devices, increased setbacks, and retention of existing vegetation;
  - (iv) Pre-existing pattern of development in the vicinity of elevated decks and balconies; and
  - (v) The visual impact of the elevated deck or balcony and any proposed privacy screening in terms of bulk and scale as viewed from the private open space and living areas of adjoining properties and from the street.
- (f) Roof tops are to be non-trafficable and not capable of being used as roof terraces or as entertainment areas, except in the following circumstances:
  - (i) There is a predominance of roof terraces in the immediate vicinity of the site;
  - (ii) They will not result in unreasonable amenity impacts such as overlooking and loss of privacy and acceptable noise;
  - (iii) They are not to exceed 15m<sup>2</sup> in area;
  - (iv) They are provided for casual and infrequent activity and not as an extension of private open space or entertaining areas; and
  - (v) Any access must be provided within the envelope of the main building and there are to be no access hoods or lift overruns proposed above the

main roof level. Operable skylights and hydraulic lifts are acceptable where they finish generally flush with the roof level.

It is acknowledged that in some areas within Waverley there are a number of large roof-top terraces. These large terraces (larger than 15m<sup>2</sup>) may impact upon the visual and acoustic privacy of adjoining properties. Control (f) above specifically aims to limit this development outcome continuing and the existence of larger roof top terraces in close proximity to the proposed roof terrace does not justify a variation from the maximum size control in (f) above.

- (g) Consideration must be given to noise mitigation measures including:
  - (i) Noise efficient building materials;
  - (ii) Avoiding noisy walking surfaces (such as external metal decks) and unenclosed elevated side passages.
  - (iii) Incorporate all sewerage, water pipes, ducting, cables, fans, vents and other utilities within the building envelope;
  - (iv) Plumbing for each dwelling is to be contained using appropriate noise resistant wall, ceiling and floor treatments in order to prevent the transmission of noise between dwellings.
- (h) External lighting is to be directed away from the main internal living areas and bedrooms of adjacent dwellings.

**1.6 SOLAR ACCESS****Objectives**

- (a) To maximise solar access to surrounding properties and the proposed development through appropriate orientation and siting.
- (b) To ensure reasonable levels of direct sunlight to living areas and private open space of lower density residential accommodation.
- (c) To maximise solar amenity and energy efficiency to existing surrounding lower density residential accommodation.
- (d) To minimise overshadowing of windows to internal living areas and private open space of surrounding dwellings.

**Controls**

- (a) Development is to be designed so as to provide for a minimum of 3 hours direct sunlight to at least 50% of the proposed living areas and principal private open space areas, when measured between 9am and 3pm during winter solstice (June 21).
- (b) Development is not to reduce the amount of direct sunlight to at least 50% of the principal private open space of adjoining properties to less than 3 hours when measured between 9am and 3pm during winter solstice (June 21).
- (c) Despite controls (a) & (b) above, where a development does not comply with a development standard and causes a reduction in direct sunlight to adjoining properties, *any* reduction may be considered unacceptable.
- (d) If the provision of direct sunlight is already below 3 hours (as per above), any reduction may be unacceptable.
- (e) Development is to avoid the unreasonable overshadowing of solar collectors on a nearby property.

## 1.7 VIEWS

It is generally accepted that views do not 'belong' to anyone or any property, nor is a view the exclusive right to any one property or to certain individuals. 'View sharing' is an important principle to consider when developing a property.

This Part should be read in conjunction with the NSW Land and Environment Court Planning Principle based on *Tenacity Consulting v Warringah [2004] NSWLEC 140* which provides general principles for the assessment of views and view sharing.

### Objectives

- (a) To minimise the impact on existing views and vistas enjoyed from existing residential development and from the public domain.
- (b) To encourage view sharing as a means of ensuring equitable access to views from private dwellings
- (c) To maintain views from public places of landmark or iconic features.

### Controls

- (a) Existing views and vistas available from the public domain, including but not limited to ocean, harbour, beach, city and parks views are to be maintained where possible by the design of buildings.
- (b) Existing views of landmark or iconic features from the public domain (such as Sydney Harbour, Opera House, Harbour Bridge, Bondi Beach) are to be maintained and where possible, enhanced. In some circumstances, complying with maximum development controls may not be achievable if an iconic view is impeded.
- (c) Lower density residential accommodation is to be designed and sited so as to enable a sharing of views with surrounding dwellings particularly from habitable rooms and decks.
- (d) Where views are enjoyed by a neighbouring property across a proposed terrace, balcony or deck, it is accepted that privacy is of lesser value than the retention of views and it may not be appropriate to erect a privacy screen.

## 1.8 CAR PARKING

### Objectives

- (a) To provide convenient and accessible parking that is appropriately designed and located.
- (b) To achieve a high standard of urban design and retain the visual quality of lower density residential accommodation, streetscapes and landscapes.
- (c) To protect the amenity and safety of pedestrians.
- (d) To ensure that car parking accommodation does not dominate or adversely impact on the existing built or landscape character of the street.
- (e) To encourage the use of alternative modes of transport in areas well serviced by public transport.
- (f) To ensure on-street parking supply is protected by minimising impacts of additional vehicular kerb crossings.

### Controls

#### 1.8.1 Design Approach

- (a) Approval for on-site parking will only be granted where the site and locality conditions permit.
- (b) Car parking must be designed to complement the design of the building and streetscape to which it relates and incorporate a range of appropriate materials and design.
- (c) Car parking structures are to be located behind the front building line to reduce visual impact upon the streetscape.
- (d) Driveways and vehicular access should be designed to minimise the loss of on-street parking wherever possible.
- (e) Access to car parking and car parking structures are to be provided from secondary streets or lanes where possible.

#### 1.8.2 Parking Rates

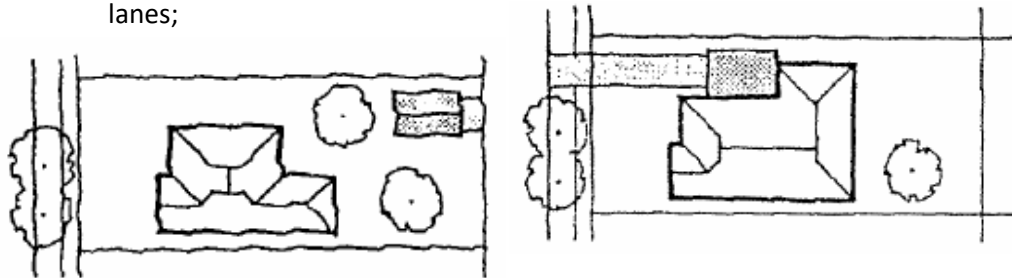
- (a) Development is to comply with the provisions of Table 4 in *Part B8 Transport*.
- (b) Notwithstanding the above, a reduced rate (or no parking) may be required in the following circumstances, where:
  - (i) Parking may have a detrimental impact on the character of the streetscape, heritage item or heritage conservation area, or health of a significant tree.
  - (ii) A driveway cannot comply with maximum gradients and design standards required by the Australian Standards.
  - (iii) Vehicle entry and exit may have a detrimental impact on pedestrian and traffic movements and safety or nearby services or infrastructure.
  - (iv) The access to the on-site car parking will result in the loss of more than 1 on-street car parking space.
  - (v) There is low on-street parking availability and no net car parking public benefit.

- (c) Where an applicant proposes to provide more than the number of on-site car spaces specified in (a), additional justification must be provided to cover matters such as, but not limited to the impact of:
  - (i) The visual impact of parking accommodation compared to alternatives such as landscaping;
  - (ii) Any increased building bulk on the streetscape;
  - (iii) Any increased building bulk on the amenity of adjoining properties;
  - (iv) The loss of existing on-street parking illustrating existing and proposed off street parking;
  - (v) The level and impact of any excavation; and
  - (vi) Access to public transport.

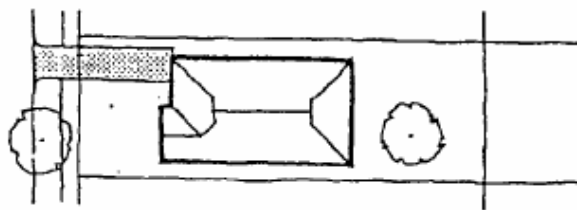
**1.8.3 Location**

- (a) For new dwellings all on-site car parking is to be located behind the front building line.
- (b) For existing development, car spaces should be sited having regard to the following hierarchy (refer to Figure 11):

- (i) Hardstand, carport or garage located at the rear of the site with access from secondary streets or lanes;
- (ii) Hardstand, carport or garage located at the side of the dwelling behind the building alignment; or



- (iii) Hardstand car space forward of the front building line.



**Figure 11** Hierarchy of preferred car parking locations

- (c) Garages on rear lanes must not create conflict with parking in the lane and result in the loss of laneway parking for any property other than the subject site.
- (d) A hardstand (in the form of wheel strips) or carport forward of the building line may be permitted where:
  - (i) There is no rear access;
  - (ii) The site is of sufficient width where the car space will not dominate the existing building (i.e. does not exceed 45% of the width of the site frontage);

- (iii) It is no greater than a single car space;
- (iv) The distance between the building and the front property boundary is a minimum of 5.4m so as to provide sufficient space for a standard car;
- (v) Public views would not be adversely affected;
- (vi) There is a predominance of this form of off street car parking in the immediate vicinity of the site;
- (vii) It is designed so that it does not detract from the heritage significance of the building or area;
- (viii) There is limited availability to public transport;
- (ix) The safety of vehicles, pedestrians and cyclists is maintained; and
- (x) There is adequate bin storage space other than on the hardstand.
- (e) Where an allotment is subdivided to create a "battleaxe" shaped allotment, the access "handle" is to have a minimum width of 3.5m.
- (f) On-site car parking (other than from rear lanes) is not acceptable in heritage conservation areas where it will:
  - (i) Break a consistent building line;
  - (ii) Introduce uncharacteristic elements within an established streetscape; and/or
  - (iii) Adversely impact on the integrity of the listed or contributory building or setting.

---

#### 1.8.4 Design

- (a) All car parking should be designed to complement the style, massing and detail of the dwelling to which it relates.
- (b) Car parking is to be sympathetically integrated into the design of residences and to be secondary in area and appearance to the primary residence and related site.
- (c) No element of the street façade/frontage of a building, including verandahs and window awnings are to be removed or demolished in order to accommodate car parking.
- (d) Car parking is to preserve the natural features of the site and incorporate substantial screen planting to both the surrounds and any structure facing the street.
- (e) Exposed natural rock faces and heritage listed sandstone walls must not be removed for any car parking.
- (f) Vehicle access is not to remove existing street planting without consent. Any street tree approved for removal is to be replaced with two like mature species or Council- approved alternate species, where practicable in front of the subject site. If only one replacement tree is practicable in front of the subject site, the second replacement tree is to be planted preferably in another Council determined location in the street, or on the site itself.
- (g) Where parking is provided for dual occupancies parking is to utilise shared access ways. Parking to dual occupancies is to be located behind the front building line and to utilise open spaces between residences preferably screened from the street.
- (h) Where existing retaining walls form part of the streetscape any new garage is to have single vehicle width entries. Entry set within stone faced exterior walls of matching stone work to that in the streetscape. Stone facing to new garages is to incorporate whole stone return corners and not mitred or butt jointed veneer.

- (i) Where gates are proposed they should have an open design to allow for improved security by way of street surveillance and are not to open over the footpath, public nature strip or pedestrian path to the front door.
- (j) All parking accommodation is to be constructed or installed so that any roof or surface water is disposed of into the existing stormwater drainage system.
- (k) The surface and slope of driveways must be designed to facilitate stormwater infiltration on site such as the use of wheel strips or alternatively porous materials.

---

**1.8.5 Dimensions**

- (a) Hardstand spaces, carports and garages should have minimum dimensions of 5.4m x 2.4m per vehicle.
- (b) All car spaces are to accommodate the vehicle within the site without the vehicle or vehicle appendages overhanging the public domain.
- (c) Internal sliding or hinged gates are to be provided to hardstands/carports to ensure enclosure of the vehicle within the site.

---

**1.8.6 Driveways**

- (a) Where possible driveways to off-street car parking should be located so they may provide vehicle access to adjacent properties.
- (b) Provide a maximum of 1 vehicle crossing per property. Properties with more than 1 dwelling, are required to share a vehicle crossing to reduce the impact to street parking and allow more space for street trees.
- (c) Driveways are to be 3.0m wide at the gutter (excluding the splay) and may splay to the property boundary as required.
- (d) Vehicle crossings will not be permitted where one off street parking space will result in the loss of two or more on street parking spaces.
- (e) A street analysis is required illustrating the number of on-street spaces provided before and after the proposed vehicle crossing.



## 1.9 LANDSCAPING AND OPEN SPACE

### Objectives

- (a) To enhance the amenity and visual setting of the site, streetscape, and surrounding neighbourhood.
- (b) To ensure the provision of open space in a size and arrangement that meets user requirements for recreation, service and storage needs, solar access and is well integrated with living areas.
- (c) To retain and increase remnant populations of endemic flora and fauna.
- (d) To maximise on site stormwater infiltration and minimise stormwater runoff.
- (e) To improve the climate resilience of the site.

### Controls

- (a) Development is to comply with the provisions of *Part B3 Landscaping, Biodiversity and Vegetation Preservation*.
- (b) A minimum of 40% of the total site area is to be provided as open space.
- (c) A minimum of 20% of the total site area is to be provided as landscaped area.
- (d) A minimum 50% of the landscaped area must be deep soil zone.
- (e) Each dwelling is to have a minimum of 25m<sup>2</sup> of private open space capable of being used for recreation.
- (f) Each dwelling in a detached dual occupancy development is to have a minimum open space area of 130m<sup>2</sup> including a private open space area having minimum dimensions of 5m x 5m located adjacent to the living area of each dwelling.
- (g) A minimum of 50% of the area between the front of the primary building and the street alignment is to be open space.
- (h) A minimum of 50% of the open space provided at the front of the site is to be landscaped area.
- (i) Each dwelling is to have an outdoor clothes drying area to allow clothes to be dried naturally.

## 1.10 SWIMMING POOLS AND SPA POOLS

This Part should be read in conjunction with State Environmental Planning Policy (Exempt and Complying Development Codes) 2008 which allows the construction of a swimming pool with a complying development certificate subject to certain criteria. Swimming pools that do not satisfy those criteria are subject to the following objectives and controls.

All applications for swimming pools over 40,000 litres in capacity must be accompanied by a BASIX Certificate. Refer to the Waverley Development Application Guide for more information.

### Objectives

- (a) To protect significant trees and landscaping on the subject site and adjoining properties.
- (b) To retain the visual and acoustic privacy of adjoining properties.
- (c) To ensure the location of swimming pools and spa pools do not adversely impact upon adjoining properties and/or streetscapes.
- (d) to ensure swimming pools can be run with optimal energy consumption

### Controls

- (a) Swimming pools and spa pools must be located at the rear of the property.
- (b) Swimming pools and spa pools should not be located within the side setback, between dwellings.
- (c) In the case of a corner block, swimming pools and spa pools must not be located within the primary street frontage.
- (d) Swimming pools and spa pools are to be setback from significant trees and landscaping in line with AS4970-2009 - Protection of trees on development sites.
- (e) Where decking abuts any boundary, additional consideration must be given to the visual privacy of adjoining properties.
- (f) Exposed pool structures must be screened if visible above ground.
- (g) All pool equipment must be enclosed within an acoustically treated structure.
- (h) All swimming pool pumps must reach a minimum of 7 stars or above under the Australian Government's Minimum Energy Performance Standards
  - (i) Acceptable swimming pool heating systems include:Solar only
  - Solar with electric boost
  - Electric heat pump

**1.11 DORMER WINDOWS****Objectives**

- (a) To ensure additions to roofs for the purposes of accommodation, are proportionate and complementary with the character of the dwelling and streetscape.
- (b) To ensure where part of a semi-detached dwelling pair, row or group, the character of dormer and roof windows is consistent in all respects, to conserve the unity of the group.

**Controls**

- (a) Where the height of the roof as measured from the gutter to the ridge is less than 2.5m, windows must be flush to the roof and limited to one per single fronted dwelling, or a pair on a double fronted dwelling.
- (b) Each dormer window is to be contained within one dormer roof structure.
- (c) The ridge of any dormer roof structure shall generally be a minimum of 300mm below the main ridge of the roof of the dwelling.
- (d) Where the dwelling is part of a semi-detached pair, row or group of like dwellings, any dormer or roof window must match the unity of the group and the total width of dormers should be no greater than 25% of the width of the roof.
- (e) In terrace style dwellings, a skillion dormer may be permitted at the rear of the roof, provided the existing ridge line is maintained, the addition is set below the ridge and a side setback of minimum 900mm is maintained. In addition, the rear skillion dormer is not to extend beyond the rear gutter line.

## 1.12 BATTLE AXE BLOCKS

A battle axe block is an allotment that has access to a road by an access laneway or 'handle'. Battle axe subdivision is not a preferred subdivision pattern in Waverley Council, however may be considered when it can be demonstrated that the subdivision will not negatively impact upon the streetscape character, or the amenity of surrounding developments.

### Objectives

- (a) To ensure battle axe block development achieves acceptable levels of quality building design, amenity, landscaping and access.
- (b) To ensure development is of a size and scale that minimises adverse impacts on the amenity of adjoining residential properties.
- (c) To minimise subdivision that results in battle axe blocks.

### Controls

- (a) Dwellings on battle axe blocks are restricted to single storey in height. Exceptions may be considered where the lot (excluding the access handle) has a minimum area of 450m<sup>2</sup>, a minimum width of 12m and a minimum depth of 12m, and the building is able to achieve large setbacks to boundaries on all sides. In such circumstances it must be demonstrated that the proposed dwelling will have minimal detrimental impacts upon adjacent residential development and the proposal shall accord with other controls in *Part C1 Low Density Residential Development* of this DCP.
- (b) The alignment of dwellings on battle axe blocks should take reference from the alignment of dwellings on adjacent sites. Where a dwelling cannot align with the predominant front and rear alignments of adjacent dwellings, it should be sited and orientated in a manner that will minimise amenity impacts on adjacent dwellings, while maximising the residential amenity to the proposed dwelling in terms of solar access and private open space.

### 1.13 SEMI-DETACHED DWELLINGS & TERRACE STYLE DEVELOPMENT

Semi-detached dwellings form a significant percentage of Waverley's existing housing stock and are being increased in numbers in the form of dual occupancies. Examples of semi-detached dwellings dating from the 1850's to the present are characterised by the principle of providing cohesive residences having the appearance of a more substantial single dwelling.

#### Objectives

- (a) To ensure alterations and additions visually read as a cohesive part of the existing dwelling from the streetscape.
- (b) Materials and detailing of design elements such as roof features are to be of a high quality and reference existing architectural style and features.
- (c) To maintain the original style, form and detail of development to provide cohesion between semi-detached or attached buildings.
- (d) To maintain the appearance of semi-detached development as one of a pair, demonstrating consistent scale, character and established streetscape values.
- (e) To retain the ability of the adjoining residence to undertake comparable cohesive additions.
- (f) To ensure that additions present as an extension of the historic form of the existing building envelope.
- (g) To ensure that the design of first floor additions provides for cohesion, both at the interface of dwellings resulting from additions to one dwelling and the overall form resulting from additions to both adjoining semi-detached dwellings.
- (h) To ensure that development affecting common or shared walls upholds the integrity and quality of the walls on all properties affected.

#### Controls

##### 1.13.1 Built Form

- (a) To protect the street frontage of the pair of semi-detached dwellings, demolition of one semi-detached dwelling of a semi-detached dwelling pair is not supported.
- (b) Where demolition of the building is required due to structural inadequacy or the like, the replacement building is to be a semi-detached dwelling and complement the character of its pair.
- (c) To protect the street frontage of the pair of semi-detached dwellings, the demolition of one existing semi-detached dwelling must not be carried out for the front 6m of the dwelling, or forward of the roof ridge line (whichever is greater).
- (d) The style of the built form must be identified and maintained across the pair or group of buildings.
- (e) The existing original style of the subject semi-detached dwelling is to form the basis of additions visible from the street.
- (f) The use of an attic room in the existing roof void of a semi-detached dwelling is permitted provided:
  - (i) Design controls for dormers are met;
  - (ii) No external balconies are proposed for the attic room;
  - (iii) The attic room maintains the existing roof form as the dominant aspect of the street frontage;
  - (iv) New works do not exceed the existing ridge height; and

- (v) New works remain cohesive with the existing roof form, pitch and finish.
- (g) Alterations to front verandahs are to be minimal and to maintain the existing verandah form, detail and finish and the relationship of the verandah to the front verandah of the adjoining semi-detached dwelling.

---

### 1.13.2 First Floor Additions to Semi-detached Dwellings

- (a) First floor additions are to be complementary to the overall building size and style.
- (b) Any first floor addition is to be set back 6m or behind the roof ridge line (whichever is greater) from the principal street frontage in order to maintain a substantial portion of the existing front roof slope and any front verandah.
- (c) Where an existing roof incorporates a main gable oriented to the street, frontage additions are to be located a minimum of 1000mm behind the main gable front.
- (d) Where an existing roof has a principal transverse ridgeline, the bulk of the additions are to be located behind the ridgeline with the exception of secondary dormers or gables set into the front roof slope.
- (e) Where first floor additions extend forward of the existing ridgeline or apex of a hipped roof:
  - (i) The width of additions is limited to no more than 50% of the existing roof of the subject dwelling; and
  - (ii) Architectural elements of semi-detached dwellings are to be retained; and
  - (iii) The extent of the existing roof form is to be contiguous with the attached dwelling.
- (f) The bulk of any first floor addition is to be located to the rear areas of the dwelling.
- (g) Flat roof forms should only be employed where not seen from the street or surrounding an important viewing position in Heritage Conservation Areas.
- (h) Uncharacteristic roof forms and details are not considered appropriate if these impact on the streetscape character of adjoining or nearby semi-detached dwellings.
- (i) Roof forms which contribute excessively to the visual bulk of the building such as high skillion roof forms will not be permitted.
- (j) First floor additions are to limit the rise of walls at the interface with the adjoining semi-detached dwelling to a height of 600mm.
- (k) Any raised party wall is to be set behind the principle ridge line and / or mitigated by detailed design.
- (l) Contemporary roof forms to the rear of traditional semi-detached dwellings may be acceptable if the visual impact to the street and the adjoining dwelling is minimised.
- (m) Where first floor additions exist to the adjoining semi-detached dwelling, the original style and form of the semi-detached dwelling is to form the basis of first floor additions.
- (n) Where symmetry or asymmetry is the dominant aspect of the original semi-detached dwelling pair, this is to be acknowledged in first floor additions.

---

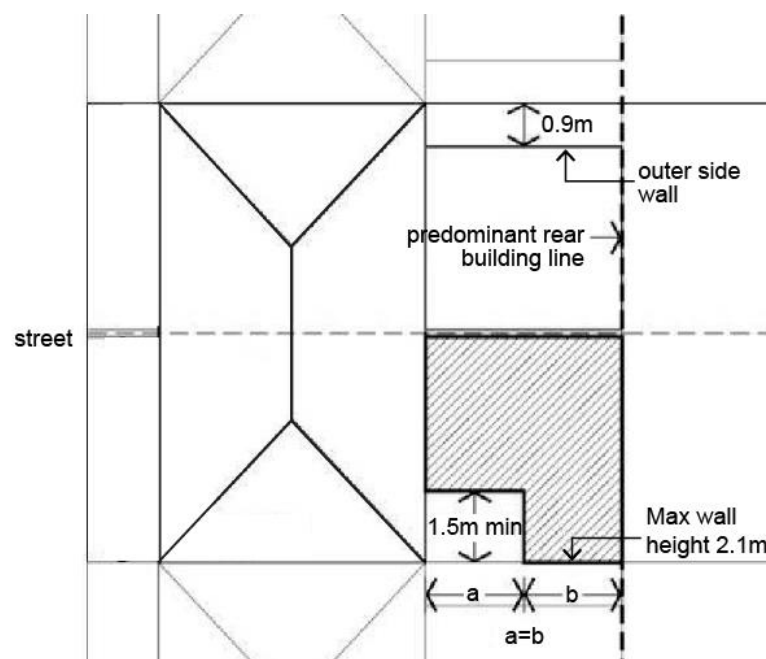
### 1.13.3 Material Finishes and Detail for Semi-detached Dwellings

- (a) Additions are to be cohesively integrated with the finishes and detail of the existing building.

- (b) The style, pitch, profile and colour of roofs to proposed additions are to match and complement the existing roof form of the dwelling.
- (c) Historic features of the existing roofscape are to be identified and where appropriate be incorporated into the proposed addition.
- (d) Dormer roof forms are to be used in a manner characteristic of the original style of the subject dwelling.
- (e) New roofing is to match the original roofing in material colour and profile. Where roofs of adjoining semi-detached dwellings are currently different to each other, new additions are to match the roofing of the adjacent semi-detached dwelling.
- (f) Windows to first and ground floor additions are to be in scale and proportionate to the original windows in the semi-detached dwelling.
- (g) Upper wall finishes are to reflect the style and character of the original building finishes.

**1.13.4 Side setback and courtyard design controls for terraces**

- (a) The common (or party) wall between a pair of terraces can be built with no side setback along the common boundary where it abuts an existing wall to the neighbouring property or where it can be reasonably expected that a wall to the neighbouring property would be constructed in the future.
- (b) The outer side wall of the building (i.e. the wall that is not a shared wall or party wall), should be set back a minimum of 900mm from the outer side boundary (refer to Figure 12).
- (c) Part of the outer side wall may be built to the outer side boundary to create an internal courtyard. The wall on this boundary should generally be a maximum of 2.1m in height. Refer to Figure 12.
- (d) Internal courtyards must have a minimum 1.5m dimension.
- (e) No openings are permitted for walls built to the side boundary.
- (f) The extension should not encroach beyond the predominant rear building line (refer to Figure 12).



**Figure 12** Example of rear extension to terrace.

### 1.13.5 Streetscape and visual impact controls for terraces

- (a) Where there is a mix of 1 and 2 storey terrace style dwellings within a terrace group, additions to one of the single storey terrace style dwellings may be acceptable if the new storey reflects the character and detail of the ground floor facade.
- (b) Extensions to the rear of an existing single storey terrace dwelling are to be no higher than the existing ridge.
- (c) In the case of attic conversions, the main roof envelope of the existing dwelling should remain intact and any dormers should be proportional in size and scale with the existing roof.
- (d) For further guidance, refer to *Part C1.3 Streetscape and Visual Impact*.

### 1.13.6 Common or shared party walls

- a) Subject to appropriateness on heritage grounds, where a previously interior party wall with no cavity becomes exterior then an appropriate second skin, and damp-proof course and waterproofing treatment will be required at the expense of the applicant.
- b) Where new common walls are constructed, they should be constructed as cavity walls with a damp-proof course.

## 1.14 DUAL FRONTAGE DEVELOPMENT

For the purposes of this section, the following definitions apply:

#### *Dual frontage development*

Where a lot has two frontages the development is dual frontage development.

#### *Laneway development*

Laneway development is a type of dual frontage development, and comprises a lot that has one primary frontage, and a secondary frontage to a lane where the predominant use of that lane is vehicle access and waste collection.

#### **Objectives**

- (a) To ensure dual frontage development addresses the character of both frontages appropriately.
- (b) To maintain and improve the key function of a lane being the provision of access to and from a site.
- (c) To ensure bulk, scale and form of dual frontage development does not have a detrimental impact on the established character of Heritage Conservation Areas.
- (d) To activate rear laneways:
  - (i) Through improved passive surveillance;
  - (ii) Through improved quality of construction and design; and
  - (iii) By establishing opportunities for improved landscaping.
- (e) To maintain and enhance aesthetic qualities of Conservation Areas.
- (f) To maintain the amenity of existing residences within the Conservation Area.



## Controls

### 1.14.1 General Controls

- (a) In the case of a single occupancy on a dual frontage lot, the development is to nominate the primary and secondary frontage. Where the secondary frontage is to an otherwise primary road, consideration is to be given to the design and proposed uses of the development to maintain and improve amenity for the surrounding properties.
- (b) The proposed use of development on a dual frontage or laneway development is to be specified. Any proposal for the development to be used as a separate occupancy must comply with the relevant provisions for this type of use.
- (c) Detached dual occupancy development and detached secondary dwelling development is to locate built forms appropriately to each frontage.
- (d) Ancillary structures including garages are to contribute to the predominant streetscape of the surrounding area.
- (e) Orientation of ridgelines is to consider and minimise impact upon neighbours' amenity.
- (f) Dormer or other roof projections are to be set a minimum of 600mm from outer garage walls and to be set a minimum of 300mm below the garage ridgeline (refer to Figure 14).
- (g) Dormers or other roof projections are to have a maximum combined width not exceeding 50% of the associated roof width.
- (h) Dormers or other roof projections and openings to gable ends are to be detailed to minimise overlooking of neighbours properties.
- (i) To maintain neighbours privacy and amenity, windows and glazed doors to above garage accommodation and storage areas are to incorporate privacy screening, translucent glazing, offset windows or other discrete detailing, cohesive to the design of the building and setting.
- (j) Single width garage doors should incorporate an adjacent pass door for pedestrian usage.
- (k) Pass doors should incorporate off street enclosure for waste bin storage.
- (l) Garage studios and rear lane garage developments are to incorporate landscape planting. Landscaping is to include but not be limited to:
  - (i) Inset pockets for tree, shrub or vine planting;
  - (ii) Overhanging planters;
  - (iii) Setback planters; and
  - (iv) Green walls utilising mesh supported climbers or vertical emphasised tree or shrub species.

### 1.14.2 Laneway design provisions

- (a) The external wall height of laneway development shall not exceed 3.6m and maximum height to the roof ridge shall not exceed 6m (refer to Figure 13).
- (b) Gabled roof ends facing side boundaries are only appropriate where the impact on neighbours is considered acceptable in terms of solar access, bulk and scale, and visual and acoustic privacy impacts.

- (c) Laneway development is to be designed with simple built forms, built at or very close to the lane alignment and is not to be seen from the primary street frontage (refer to Figures 14 and 15).
- (d) Laneway development design should incorporate a pitched roof. Skillion roofs located behind parapets may be acceptable in some instances where the prevailing laneway development is consistent with such an approach and where it will result in fewer impacts to the amenity of adjacent properties.
- (e) Development along lanes is to maintain the prevalence of mature, regularly spaced street trees and bushes, as well as mature and visually significant trees on private land. Laneway development should not occur if it will result in a significant alteration to the landscape character of the laneway.
- (f) External stairs are not acceptable in order to protect the visual and acoustic privacy of adjoining properties and to maintain an appropriate aesthetic quality of the development.
- (g) Rear lane garages are to employ gable ended and hipped roof forms with continuous roof pitch from outer walls to ridgeline.

---

### 1.14.3 Development in Heritage Conservation Areas

#### Garage Articulation

- (a) Garage doors are to be limited to single vehicle widths, with central divide to double vehicle garages (refer to Figure 14).
- (b) Roof forms are to reflect those of the Conservation Area in pitch and modulation.
- (c) Garage/studio finishes are to reflect the finishes and proportions of traditional construction in the Conservation Area.
- (d) Proportions of openings to studios are to maintain the proportions and voids to solid ratios of traditional construction in the Conservation Area.
- (e) Windows to above garage studios are to be designed to minimise overlooking of surrounding properties both adjacent to the site and on opposing sides of laneways. Outlook is to be directed into the associated property or into the rear lane.
- (f) Treatment of windows and glazed openings to studios is to incorporate privacy screening to or from neighbouring sites including but not limited to obscure glazing, window hoods, awnings and recessed window planes.
- (g) Garage studio structures are to be visibly separate from the associated residence. Yard areas and private open space areas are not to be roofed.
- (h) The massing and roof line of garage/studio structures are to align with garage/studios on neighbouring sites. Box gutters on side boundaries are to be avoided. Solar collection panels are to be located to inner roof slopes facing the associated residence or to roof slopes facing side boundaries.

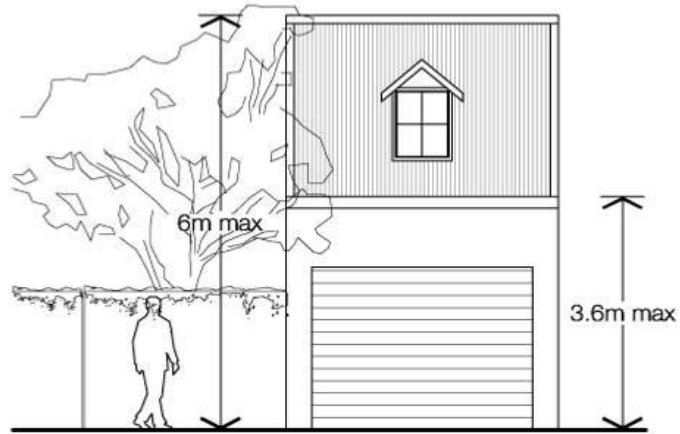


Figure 13 Maximum overall and external wall height for laneway development



Figure 14 Example of acceptable designs for laneway development



Figure 15 Laneway development should not be visible from the primary street frontage

## 1.15 DUAL OCCUPANCY DEVELOPMENT

This section does not apply to secondary dwellings, also known as granny flats (refer to *Part C1.16 Secondary Dwellings and Ancillary Structures*).

### Objectives

- (a) To ensure that the size and bulk of dual occupancy development is in character with surrounding development and streetscape.
- (b) To ensure that the size and bulk of new buildings and alterations and additions to dual occupancy developments do not result in unreasonable impacts on neighbouring properties.

### Controls

- (a) The allotment area for a dual occupancy development must be consistent with the following:
  - (i) 450m<sup>2</sup> or more where the two dwellings are attached; or
  - (ii) 600m<sup>2</sup> or more where the two dwellings are detached.
- (b) Attached dual occupancy development should be designed so as to have the appearance from the street of a single dwelling.
- (c) In the case of a detached dual occupancy, any second building must:
  - (i) Address a street or laneway;
  - (ii) Have a maximum gross floor area of 110m<sup>2</sup>; and
  - (iii) Not exceed the maximum FSR for the site, as calculated for the whole site.
- (d) A detached dual occupancy must provide a minimum 5.5m courtyard area between each dwelling.
- (e) Dual occupancy development must provide a single vehicle crossing to the street.

## 1.16 SECONDARY DWELLINGS AND ANCILLARY BUILDINGS

*State Environmental Planning Policy (Housing) 2021* permits secondary dwellings in all residential zones and includes development standards for secondary dwellings. This Part provides additional development controls that are to be read in conjunction with the SEPP. Where there is an inconsistency between the Housing SEPP and this DCP, the development standards in the Housing SEPP prevail.

To ensure amenity and restrict overdevelopment of a site, the principal dwelling plus any ancillary structures, including secondary dwellings, are to comply with the controls in *Part C1 Low Density Residential Development* for site coverage, minimum landscaped area, private open space, and height controls.

### Objectives

- (a) To ensure secondary dwellings and ancillary development achieve acceptable levels of building design, amenity, landscaping, access and security.
- (b) To limit the bulk and scale of secondary dwellings and ancillary development.
- (c) To avoid excessive development of existing landscaped areas and open space of dwellings.
- (d) To minimise the adverse amenity impacts of secondary dwellings and ancillary buildings on adjoining properties.
- (e) To ensure secondary dwellings and ancillary development enhances the streetscapes of laneways and primary streets.

### Controls

#### 1.16.1 Secondary Dwellings

- (a) Secondary dwellings are to comply with the provisions of Clause 5.4(9) of WLEP. Where secondary dwellings are proposed to address the rear lane, the provisions in *Part C1.14 Dual Frontage Development* will also apply.
- (b) Any detached secondary dwelling must clearly read as a secondary structure associated with the principle dwelling.
- (c) Secondary dwellings are not to significantly impact upon the privacy and amenity of neighbouring properties.
- (d) Secondary Dwellings must comply with the provisions of Part B1 Waste and provide storage for waste in addition to the primary dwelling.
- (e) Parking permits will not be permitted for residents of a secondary dwelling.
- (f) Secondary dwellings that do not front a laneway are to be single storey only, with an overall maximum height of 3m.
- (g) Side setbacks of secondary dwellings are to be determined on a site by site basis, with consideration given to the context and amenity of neighbouring properties.

#### 1.16.2 Ancillary Development

- (a) Ancillary buildings are to be minor buildings, integrated into the landscaped open space area of the dwelling, with the floor area of all ancillary buildings on an allotment not exceeding 10% of the allotment size.

- (b) The wall height of the ancillary buildings on a property boundary shall not exceed 2.1m. Maximum wall height must not adversely impact on the amenity of a neighbouring property.
- (c) The maximum height of ancillary buildings is not to exceed 2.4m.
- (d) The design of the roof of ancillary buildings should not conflict aesthetically with the design of the principal building on the site or with adjoining development.

## C2 OTHER RESIDENTIAL DEVELOPMENT

Development is to comply with the provisions of this part, as well as other relevant parts of this DCP. Where there are inconsistencies, the provisions of this Part shall prevail to the extent of the inconsistency. This Part applies to the residential components of:

- Boarding Houses;
- Co-living housing;
- Group homes;
- Hostels;
- Manor Houses;
- Multi dwelling housing;
- Multi dwelling housing (terraces);
- Residential flat buildings;
- Seniors housing;
- Serviced apartments;
- Shop top housing; and
- Student accommodation.

*State Environmental Planning Policy (Exempt and Complying Development Codes) 2008 (Code SEPP).*

For the purposes of 'Low Rise Medium Density' development as permitted through Part 3B of the Code SEPP, this Part is to be considered in the design and assessment of manor houses and multi dwelling housing (terraces). Refer to the Code SEPP for the land use definitions of manor houses and multi dwelling housing (terraces).

*State Environmental Planning Policy (Housing) 2021 – Chapter 4 Design of residential apartment development (Housing SEPP)*

Development that is subject to Chapter 4 of the Housing SEPP is required to address the provisions of the Apartment Design Guide (ADG), in addition to this part of the DCP. As per Clause 149 of the Housing SEPP, if a DCP contains provisions that specify requirements, standards, or controls in relation to the following, those provisions are of no effect:

- (a) visual privacy,
- (b) solar and daylight access,
- (c) common circulation and spaces,
- (d) apartment size and layout,
- (e) ceiling heights,
- (f) private open space and balconies,
- (g) natural ventilation,
- (h) storage.

Where this is the case, a notation has been placed next to the relevant section of this Part. Given the nature of the existing and desired future character of Waverley, in many cases where the above provisions of the ADG cannot be achieved, the provisions of the relevant Part of this DCP are intended to provide additional guidance in achieving the relevant objectives.

**CONTENTS**

**C2 OTHER RESIDENTIAL DEVELOPMENT ..... 214**

2.1 Site, Scale and Frontage ..... 216

2.2 Height ..... 217

2.3 Setbacks ..... 220

2.4 Length and Depth of Buildings ..... 222

2.5 Building Design and Streetscape ..... 223

2.6 Attic and Roof Design ..... 224

2.7 Fences and Walls ..... 226

2.8 Pedestrian Access and Entry ..... 227

2.9 Landscaping ..... 228

2.10 Communal Space ..... 229

2.11 Private Open Space ..... 230

2.12 Vehicular Access and Parking ..... 232

2.13 Solar Access and Overshadowing ..... 233

2.14 Views and View Sharing ..... 234

2.15 Visual Privacy and Security ..... 236

2.16 Dwelling Size and Layout ..... 238

2.17 Ceiling Heights ..... 239

2.18 Storage ..... 240

2.19 Acoustic Privacy ..... 241

2.20 Natural Ventilation ..... 242

2.21 Building Services ..... 243

2.22 Retention of Affordable Rental Housing ..... 244



## 2.1 SITE, SCALE AND FRONTAGE

### Objectives

- (a) To ensure lot size and dimension are able to accommodate the appropriate building envelope, landscaping and service requirements.
- (b) To ensure development sites have adequate street frontage to meet side setback and building requirements.
- (c) To ensure lot sizes and building forms are appropriate to the streetscape.
- (d) To provide guidance on the appropriate scale of development to complement the FSR controls within the WLEP.
- (e) To encourage amalgamation of allotments to provide for improved design outcomes.
- (f) To prevent the isolation of sites.

### Controls

- (a) New residential flat buildings must be located on sites which feature a minimum frontage width (measured at the boundary) of 15 metres for R3 zones and 20 metres for R4 zones.
- (b) Variations to control (a) may be accepted if Council can be satisfied that the development:
  - (i) Complies with the site and building design controls outlined in this Part between sections 2.2 to 2.21.
  - (ii) Provides safe and efficient access and servicing facilities - particularly in relation to parking, pedestrian and vehicle access, collection and storage of waste.
  - (iii) Provides a high standard of resident amenity - particularly in relation to privacy, solar access, ventilation, and the provision of outlooks to landscaped setbacks.
  - (iv) Responds to the local context, including providing adequate separation from existing and future adjoining development.
- (c) Lot sizes and dimensions must enable development to be sited to protect the natural or cultural features of the site and avoid significant changes to the natural topography.
- (d) Applications for new residential flat building development must not result in the isolation of neighbouring lots by reducing the development potential of adjoining land. Applicants may be required to submit plans that clearly identify the future development potential of adjoining land to ensure its development potential will not be adversely impacted. Considerations should include the ability for neighbouring sites to comply with the requirements of this DCP and the ADG.
 

**Note:** Assessment of applications will need to refer to the Planning Principles established by the Land and Environment Court *Karavellas v Sutherland Shire Council [2004] NSWLEC 251*.

**2.2 HEIGHT**

**Objectives**

- (a) To ensure future development responds to the desired scale and character of the street and local area.
- (b) To minimise the impact of attics and basement car parks on the overall building height.
- (c) To provide good residential amenity for dwellings.

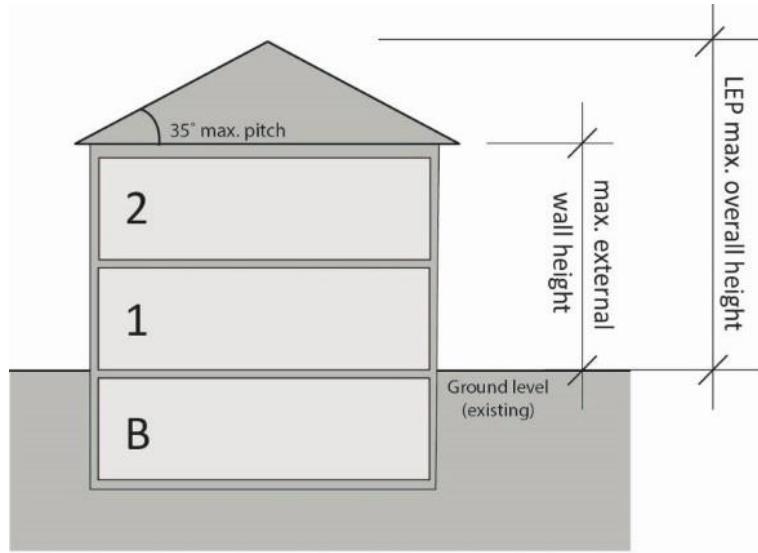
**Controls**

- (a) The maximum building height is as set by Clause 4.3 of the WLEP and the Height of Buildings Map.
- (b) Development must comply with the maximum external wall height (refer to Figures 16 - 18), as set in Table 2 below:

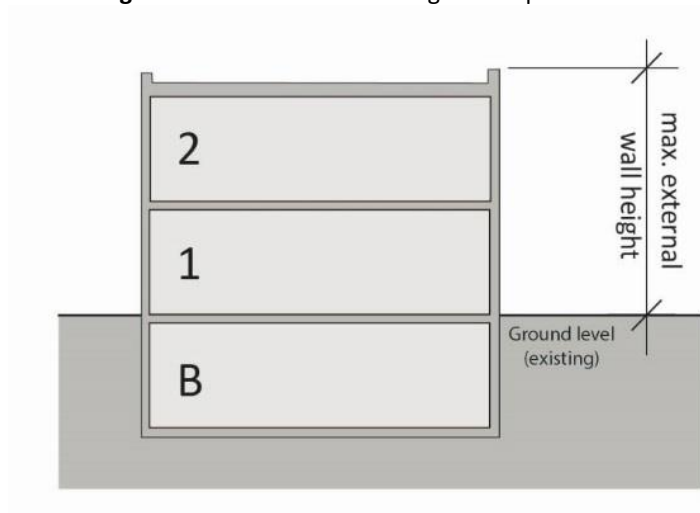
Zoning	WLEP Height	Max external wall height
R3	9.5m	7m
R3	12.5m	9.5m
R4	20m	17m
R4	28m	25m

**Table 2** Height requirements

- (c) Council may consider a varied wall height where the following matters are addressed:
  - (i) Compliance with Floor Space Ratio development standard;
  - (ii) Compliance with Height development standard;
  - (iii) Compliance with side setback controls;
  - (iv) Visual aspect of the bulk and scale, as viewed from the private open space and living areas of adjoining properties;
  - (v) Amenity of adjacent properties with regard to sunlight, visual and acoustic privacy and views; and
  - (vi) A high design quality is achieved.

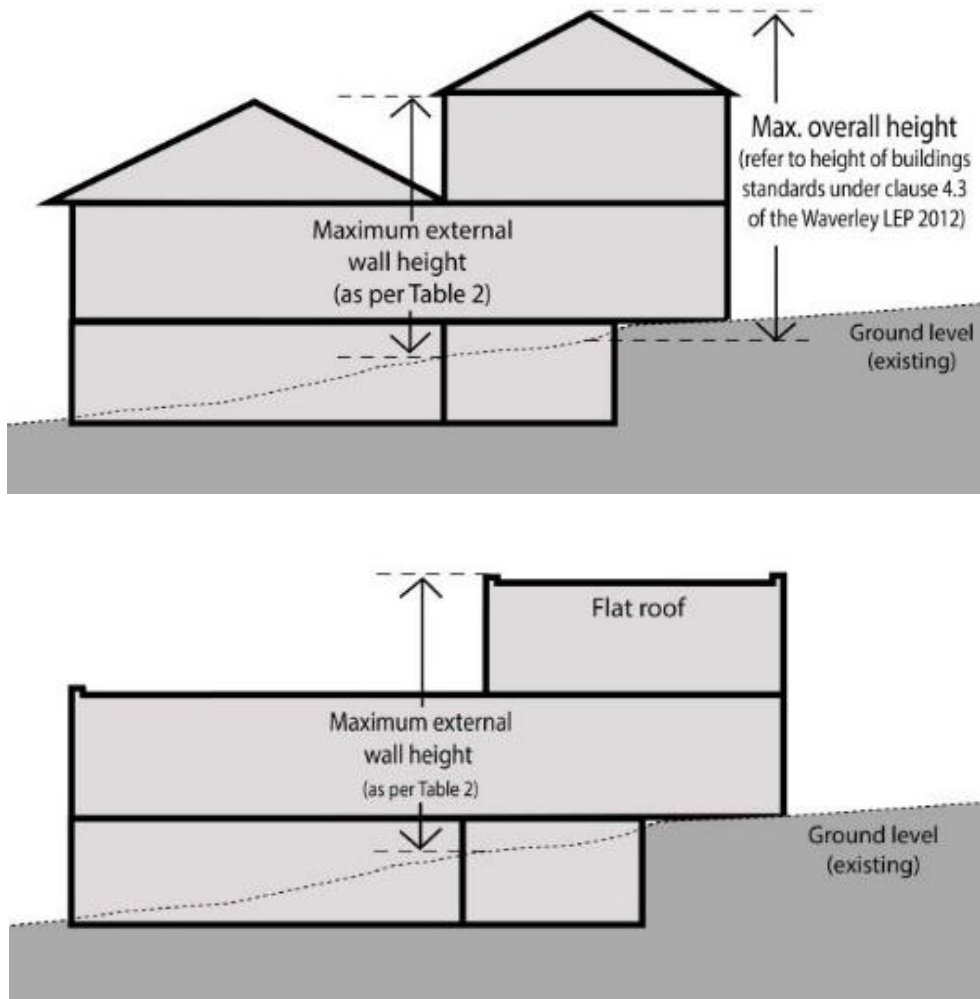


**Figure 16** How to measure height for a pitched roof building



**Figure 17** How to measure height for a flat roof building

Note: The maximum building height (LEP) is calculated from the basement floor for sites with an existing basement. The maximum external wall height only includes the portion of wall above ground.



**Figure 18** How to measure height on sloping land

Note: The maximum building height (LEP) is calculated from the basement floor for sites with an existing basement. The maximum external wall height only includes the portion of wall above ground.

## 2.3 SETBACKS

ADG Development: refer to Part 3F of the ADG.

### 2.3.1 Street Setbacks

#### Objectives

- (a) To integrate new development within the established setback character of the street.
- (b) To provide a transition between public and private space.
- (c) To assist in achieving visual privacy to dwellings from the street.
- (d) To ensure developments preserve and contribute to the landscape character of the street.

#### Controls

- (a) Street setbacks must be consistent with the predominant building line setback along the street.
- (b) Where there is no predominant building line, setbacks will be assessed on the merits of the proposal.
- (c) The front setback is to be free of any below ground structures.
- (d) An increase in setbacks may be required to retain existing trees.
- (e) The front setback is to have a soil depth to support mature trees and shrubs that contribute to the streetscape and the amenity of the public domain.
- (f) Where the property is adjacent to a Council park or reserve, no portion of the proposed development including the footings, gates, roof eaves and fences are to encroach over the Council land.
- (g) Setbacks above street frontage height are to be included where the adjacent building includes upper levels setbacks.

### 2.3.2 Side and Rear Setbacks

#### Objectives

- (a) To provide for visual relief and reduce perceived bulk between buildings
- (b) To provide for visual and acoustic privacy, solar access, air circulation and maintaining views between buildings.
- (c) To retain and reinforce existing mature vegetation to maximise natural site drainage, protect the water table, and provide screen planting.
- (d) To provide sufficient space for new mature landscaping that positively contributes to the landscape of the site, and its presence in the streetscape.

#### Controls

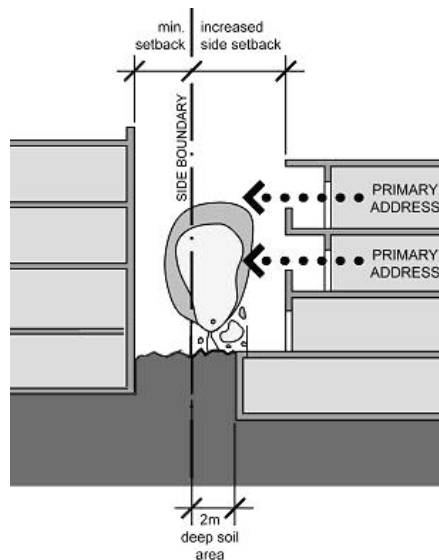
- (a) New buildings and extensions to existing buildings are to provide a minimum 6m rear setback, or extend no further to the rear than the predominant rear building line, whichever is the greater setback. The predominant rear setback is determined separately for each level.
- (b) Side setbacks are to be consistent with Table 3. Reduced setbacks may be permitted where reduced setbacks are more in keeping with the character of the

area. A Context Analysis (see Part B11.2) is to be provided to support a merit based assessment for a more appropriate setback.

Height	Side setback to whole building (min.)
Height up to 4.5m	0.9m
Height up to 12.5m	1.5m
Height above 12.5m	1.5 – 2.5m

**Table 3** Minimum side setbacks

- (c) Council may require additional setbacks to ensure adequate solar access to adjacent buildings and privacy or to minimise view loss (refer to Figure 19). In particular, additional setbacks will be required for the following:
  - (i) East-west orientated lots
  - (ii) Where there is a predominant rear building alignment
  - (iii) Steep topography
  - (iv) Retention and protection of significant trees
- (d) A landscaped deep soil area of 2m must be provided along one side boundary at a minimum.



**Figure 19** Side setbacks

## 2.4 LENGTH AND DEPTH OF BUILDINGS

ADG Development: refer to Part 3F of the ADG.

### Objectives

- To ensure development responds to the existing subdivision pattern and the scale of surrounding buildings.
- To continue the pattern of sightlines through to the rear of blocks between buildings along the street.
- To have a high standard of amenity for occupants of dwellings.

### Controls

- The maximum length of a building along a street is 24m (refer to Figure 20).
- Within the maximum length, buildings must be articulated to respond to the established pattern of existing building length along the street.
- The maximum depth of any residential flat building is to be 18m.

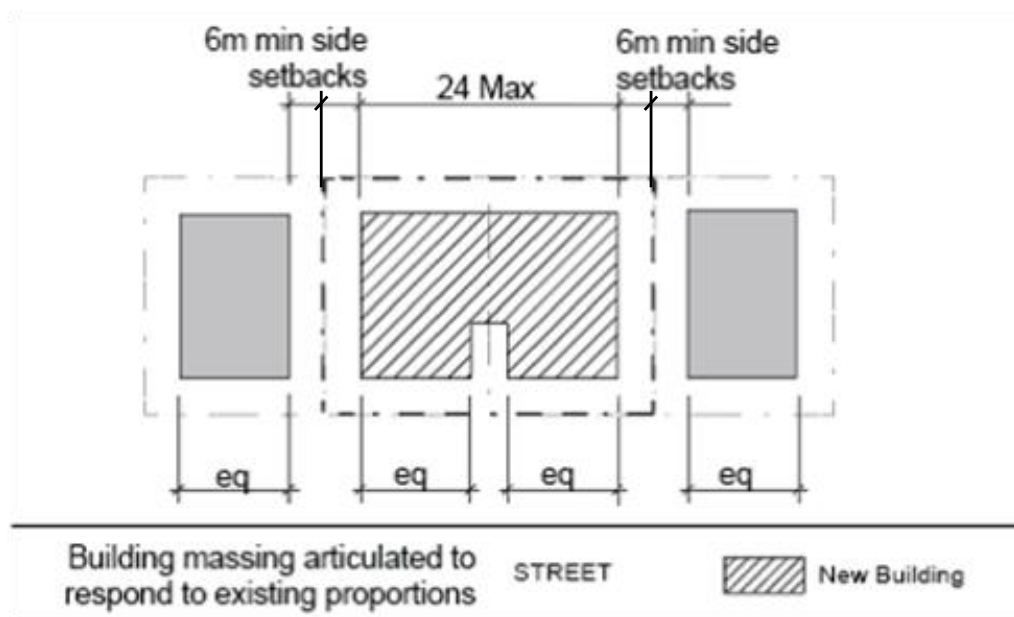


Figure 20 Building length controls

## 2.5 BUILDING DESIGN AND STREETScape

### Objectives

- (a) To have development of a scale and appearance in keeping with the street.
- (b) To design residential development to respond to the streetscape character.
- (c) To promote high quality architectural design.
- (d) To ensure alterations and additions maintain the original architectural character of existing residential flat buildings.
- (e) To ensure that contributory elements of a streetscape are considered in building design.
- (f) To ensure neighbourhoods and streetscapes have a rich character.

### Controls

- (a) Development must be sensitive to the streetscape character and views. A streetscape and context analysis is to be provided in accordance with *Part B12 Design Excellence*.
- (b) Building design is to respond to the existing streetscape character of the area.
- (c) The design of alterations and additions should demonstrate architectural compatibility with the existing building.
- (d) The colour and finish of external materials should be sympathetic to the streetscape and contribute to the overall appearance of the building.
- (e) For developments on corner sites, both street frontages are to present as a primary street frontage.
- (f) The removal of original architectural details and finishes is not supported including; painting face brick work or sandstone, replacing timber with aluminium or replacing unglazed terra cotta tiles or slate.
- (g) Where a streetscape is characterised by Inter-War buildings, infill development should be sympathetic to the surrounding Inter-War features, using Part B16 of this DCP and the *Waverley Inter-War Building Design Guidelines* for guidance. Infill development should not copy an Inter-War building, but rather exhibit design excellence and innovation to provide a contemporary form with sympathetic materials and proportions.



## 2.6 ATTIC AND ROOF DESIGN

**Definition:** Attic means any habitable space, but not a separate dwelling, contained wholly within a roof above the ceiling line of the storey immediately below, except for minor elements such as dormer windows and the like.

### Objectives

- (a) To ensure attic rooms achieve good residential amenity and environmental performance.
- (b) To minimise the impact of attic rooms on the amenity of adjoining properties.
- (c) To allow a variety of roof forms in response to the scale and character of the building and streetscape.

### Controls

- (a) Roof design should contribute to the architectural design and the environmental performance of the development.
- (b) Roof design should respond to the streetscape character of the area.
- (c) Alteration and additions must consider existing streetscape and the impact on neighbouring views.
- (d) Contemporary roof forms are permitted to minimise bulk and scale, and respond appropriately to the context.
- (e) An attic must be wholly contained within a pitched roof form; that is a hipped or gabled roof, but not a flat or skillion roof (with the exception of dormer windows).
- (f) An attic must not increase the bulk and height of the roof.
- (g) Attic levels must:
  - (i) Ensure the pitched roof form is the major visual element of the roof and must respond to the context;
  - (ii) Not exceed 50% of the floor area of the floor below;
  - (iii) Not contain independent dwellings and must be accessed via internal stairs only; and
  - (iv) Be naturally ventilated using cross or stack ventilation.
- (h) Attic rooms must have a minimum width of 3m and must have a minimum floor to ceiling height of 2.4m, for at least two thirds of the floor area of the room (refer to Figure 21).
- (i) Dormer windows and skylights are to be less than 50% of the area of the roof elevation.
- (j) Attic additions must not contain a single expansive dormer window. Multiple smaller dormers are preferred where appropriate.
- (k) Where dormer structures are proposed they must:
  - (i) Be secondary to the primary roof structure; and
  - (ii) Be set down a minimum of 300mm from the main ridge line.

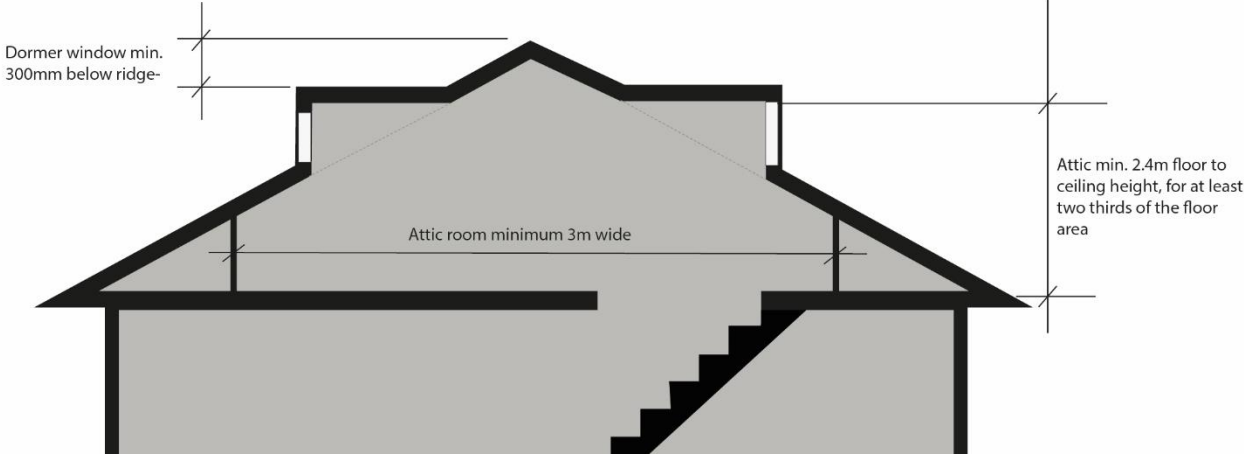


Figure 21 Pitched roof minimum attic dimensions

## 2.7 FENCES AND WALLS

### Objectives

- (a) To define boundaries between communal and private areas within the site and to provide privacy and security for the development.
- (b) To promote a cohesive streetscape.
- (c) To ensure fencing contributes positively to the streetscape or adjoining park.
- (d) To ensure boundary treatments of properties adjoining parks are consistent with the materials palette in the relevant plan of management to maintain the amenity of parks.

### Controls

- (a) Front fences are to be provided where it is a predominant character of the street frontage within a street block.
- (b) Front fences must not exceed 1.2m in height. On sloping sites, the height is averaged so that fences step down the street.
- (c) Front fences must have a maximum proportion of two thirds solid to one third open design.
- (d) Council may permit front fences up to a height of 1.8m of solid material provided it can be shown that the fence acts as an effective noise barrier as a result of adjoining a street with high traffic volume. Such fences are to be setback from the boundary to allow landscaping to soften the bulk or the structure is to be articulated as an alternative to a solid blank wall.
- (e) Rear and side fences behind the building line must not exceed 1.8m in height.
- (f) Side fences must taper down from the front building line to the front boundary fence.
- (g) Fences are to respond to the architectural character of the street in terms of materials used, predominant height, vertical/horizontal rhythm and predominant setback.
- (h) Fences are to clearly delineate between public, communal and private areas.
- (i) Fencing is to be designed so that sightlines between pedestrians and vehicles exiting the site are not obscured and gates do not open over the public roadway or footpath or into parks.
- (j) All boundary treatments for properties adjoining parks are consistent with the material palette from the relevant plan of management.
- (k) The design of fences should generally relate to the period and architectural style of building and help to integrate development into the existing streetscape.

## 2.8 PEDESTRIAN ACCESS AND ENTRY

### Objectives

- To ensure developments provide high quality, accessible and safe pedestrian access to all people who live in and visit the development.
- To create entrances which provide a desirable residential identity for the development to orientate visitor(s).
- To contribute positively to the streetscape and building façade design.
- To promote development that has a strong connection to the street and contributes to the accessibility of the public domain.

### Controls

- Provide main building entries at street level which respond to patterns in the streetscape. Refer to Figure 22.
- Provide an accessible path of travel from the street to and through the front door of all dwellings on the ground floor.
- To increase accessibility, applicants should consider providing lifts in buildings of more than two habitable levels.
- Separate and clearly distinguish between pedestrian access ways and vehicle access ways/building service areas (e.g. garbage rooms).
- Locate entries so that they relate to the existing street and subdivision pattern, street tree planting and pedestrian footpath.
- Provide main building entries that are legible, safe and well lit.
- Provide as direct a physical connection as possible between the street and the building entry.
- Where appropriate, provide individual ground floor dwelling entries that address the street.

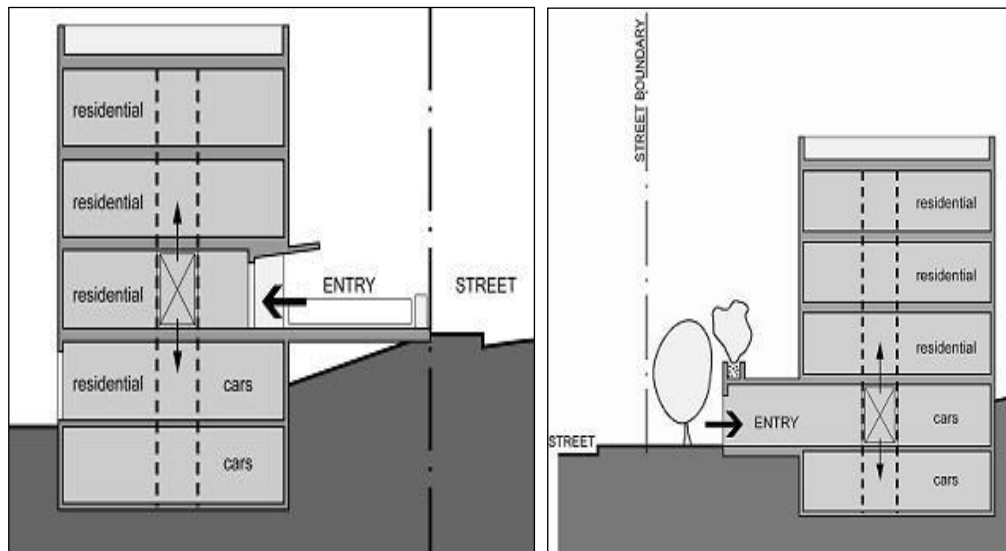


Figure 22 Entry level at low and high side of the street

## 2.9 LANDSCAPING

**Definition:** The definition of ‘landscaped area’ is the same as the definition adopted in the WLEP and is defined as “*a part of a site used for growing plants, grasses and trees, but does not include any building, structure or hard paved area.*”

### Objectives

- (a) To preserve and enhance native wildlife populations and habitat through appropriate planting of indigenous vegetation.
- (b) To encourage mature and substantial tree planting to improve the amenity of developments.
- (c) To allow for landscaping to provide screening between buildings.
- (d) To ensure landscaped areas are useable and maintainable spaces that contribute to the existing landscape character of the street.
- (e) To minimise the extent of impervious areas and facilitate rainwater infiltration.
- (f) To influence the microclimate of open space within the development.

### Controls

- (a) Development is to comply with the provisions of *Part B3 Landscaping, Biodiversity and Vegetation Preservation* and Part C2.3.2(d).
- (b) 30% of the site area is to be provided as landscaped area.
- (c) 50% of the landscaped area must be deep soil zone.
- (d) Where site conditions allow, the deep soil zone is to be consolidated as one area to assist the ease of drainage and to allow for effective deep soil planting.
- (e) Landscaping must relate to the building scale and assist integration of the development with the existing street character.
- (f) All development proposals are to be designed to eliminate the impact upon significant trees on site, street trees and trees on adjoining land including public open space and bushland.
- (g) For developments with podium landscaping, compliance with *Part B3 Landscaping, Biodiversity and Vegetation Preservation* is required.

## 2.10 COMMUNAL SPACE

### Objectives

- (a) To provide communal indoor and outdoor areas of high design quality.
- (b) To provide space to encourage interaction between residents.
- (c) To encourage a positive street address for the development.
- (d) To provide residents with recreational opportunities.
- (e) To provide a pleasant outlook for development.

### Controls

- (a) 15% of the total site area for development in the R3 zone is to be provided as consolidated communal open space.
- (b) 25% of the total site area for development in the R4 zone is to be provided for R4 as consolidated communal open space.
- (c) Communal open space is to:
  - (i) Be consolidated into a useable area with a minimum dimension of 6m x 6m.
  - (ii) Be located so that solar access is maximised.
  - (iii) Provide a landscape buffer between buildings.
  - (iv) Be designed to a high quality, and allow for landscaping and seating.
  - (v) Demonstrate that its size and dimensions allow for a variety of uses, complementary to balconies and private courtyards. These may include active recreation (BBQ or play areas) or passive amenity (shade trees/structures, water features, seating).
- (d) Communal open space may be provided on a podium or roof-top terrace provided the controls within this Part are met.
- (e) In considering a roof-top terrace or deck, Council will consider the magnitude of the impact on both privacy and noise for neighbouring residents, with the reasonableness of the proposal.
- (f) Where developments are unable to achieve the recommended communal open space, such as small developments (5 or less dwellings) or sites within business zones, they must:
  - (i) Provide quality communal indoor space within the development; and/or
  - (ii) Provide significantly larger balconies or greatly increased private open space for dwellings; and/or
  - (iii) Demonstrate proximity to public open space and facilities; and/or
  - (iv) Provide significant contributions to public open space.
- (g) At least 30% of the communal open space is to receive 3 hours of direct sunlight between 9am and 3pm on June 21.
- (h) Communal open space is to be accessible to all dwellings within a development.
- (i) A continuous accessible pathway of travel is to be provided from all entrances to all of the common facilities on site.
- (j) All facilities in communal areas are to be constructed so as to enable their use by people with disabilities.

## 2.11 PRIVATE OPEN SPACE

ADG Development: refer to Part 4E of the ADG.

### Objectives

- (a) To provide all dwellings with access to private open space.
- (b) To provide private open space of useable proportions.
- (c) To ensure solar access and privacy for private open spaces.
- (d) To ensure balconies are integrated into the overall architectural form and detail of the building.
- (e) To balance the provision of private open space with the provision of solar access and amenity within the dwellings.
- (f) To protect the privacy of residents within and around the development.

### Controls

- (a) Private open space is to have a northerly aspect where practicable.
- (b) Private open space is to be provided for at least 75% of dwellings and may be in the form of a courtyard, deck, balcony or the like.
- (c) Swimming pools are not to be included in any calculation of private open space area.
- (d) Private open space is to be directly accessible from the main living area of the dwelling.

#### 2.11.1 Courtyards

- (a) Private courtyards must have the following minimum dimensions:
  - (i) Minimum 25m<sup>2</sup> area; and
  - (ii) Minimum width and depth of 3m.
- (b) Provide opportunity for planting in private courtyards, including access to deep soil zones wherever possible.
- (c) Private open space is not to be provided at the front of the building unless a landscape buffer between the private open space and the street is provided.
- (d) Provide a clear distinction, and adequate privacy, between private courtyards and public/common open space.
- (e) Private courtyards are to have a maximum gradient of 1 in 10.
- (f) Sun screens, pergolas, shutters and operable walls are to be used to increase amenity where appropriate, and to ensure privacy for neighbours.

---

**2.11.2 Balconies/ Decks**

- (a) Balcony additions are to be designed to relate to the character of the existing building.
- (b) Balconies should not visually dominate the façade. This may require balconies to be limited in width, and to be designed as re-entrant or Juliet balconies.
- (c) Continuous wrap around balconies that add to the bulk of the building are not encouraged. The enclosure of balconies for the purpose of additional floor space is discouraged.
- (d) Enclosure of balconies for weather protection is discouraged.
- (e) Locate primary balconies to achieve maximum solar access and privacy. Sun screens, pergolas, shutters and operable walls are to be used to increase amenity where appropriate, and to ensure privacy for neighbours.
- (f) Design balustrades to allow views and casual surveillance of the street, whilst maintaining visual privacy.



## 2.12 VEHICULAR ACCESS AND PARKING

This Part must be read in conjunction with *Part B7 Transport* of this DCP for applicable parking rates and other transport provisions.

### Objectives

- (a) To provide adequate parking on site within new developments.
- (b) To encourage large developments to provide car parking in underground basements.
- (c) To integrate adequate car parking without compromising street character, landscape quality, the provision of deep soil zones or pedestrian amenity and safety.
- (d) To encourage increased use of public transport and bicycles.

### Controls

- (a) The siting of car parking must be integrated into the design of the development ensuring the building façade is the dominant streetscape element.
- (b) The car park entry is to be secondary to pedestrian building entry.
- (c) A maximum of one 2-way vehicular access point per individual development is to be provided.
- (d) Car park access is to be provided from secondary streets or lanes.
- (e) The safety of pedestrian entry and circulation is not to be compromised by the location of driveways and car park access.
- (f) The provision of basement parking must not result in non-compliance with the deep soil zone controls in *Part C2.9 Landscaping*.

**2.13 SOLAR ACCESS AND OVERSHADOWING****ADG Development: refer to Part 4A of the ADG.****Objectives**

- (a) To ensure daylight access is provided to all habitable rooms.
- (b) To provide adequate ambient lighting and minimise the need for artificial lighting during daylight hours.
- (c) To provide adequate solar access to open spaces.
- (d) To minimise impacts of development on surrounding properties.
- (e) To allow the development of small infill sites where access to direct sunlight is compromised by existing adjacent buildings.

**Controls**

- (a) Living rooms and private open spaces of at least 70% of dwellings in a development are to receive a minimum of three hours direct sunlight between 9:00am and 3:00pm on June 21.
  - (i) Developments which seek to vary the minimum standards must demonstrate how site constraints and orientation prohibit the achievement of these standards.
  - (ii) Excavation for the purposes of subterranean dwellings, which do not receive the required minimum access to sunlight, is not acceptable.
- (b) New development should not reduce the solar access of solar panels of any property to less than two hours per day in mid-winter except solar hot water and photovoltaic panels to which full solar access must be maintained.
- (c) Direct sunlight to north facing windows of habitable rooms and all private open space areas of adjacent dwellings should not be reduced to less than 3 hours between 9.00am and 3.00pm on June 21.

The numerical guidelines will be applied with the NSW Land and Environment Court Planning Principle for sunlight (in accordance with the case of *The Benevolent Society v. Waverley* [2010] NSWLEC 1082)

## 2.14 VIEWS AND VIEW SHARING

Many properties in Waverley enjoy views of local and district areas and landmarks, including Sydney Harbour, the coastline, ocean and open space. Views are often available from public places and private properties situated a considerable distance from proposed development.

A distant view does not in itself 'belong' to anyone or any property, nor is a view the exclusive right to any one property or to certain individuals. Nonetheless views and vistas are a desirable aspect of amenity and can contribute significantly to the enjoyment of the owners and occupiers of a property and also the general public.

It is difficult to quantify the significance and importance of a view and it can be a highly subjective matter. For this reason, this Part should be read in conjunction with the NSW Land and Environment Court Planning Principle based on *Tenacity Consulting v Warringah Council* [2004] NSWLEC 140 at 25-29.

### Objectives

- (a) To ensure that views are shared, providing equitable access to views from dwellings.
- (b) To protect and enhance views from streets and other public spaces.
- (c) To ensure that the desire for view does not conflict with privacy.

### Controls

- (a) New development should be designed to minimise view loss to adjoining and adjacent properties while still providing opportunities for views from the development itself (refer to Figures 23 and 24).
- (b) Provide articulation, and minimise the bulk and scale of roof forms on the low side of streets allowing views to the landscape beyond.
- (c) Design the landscape to allow for views between buildings, particularly on the low side of streets.
- (d) Where the property is adjacent to a Council park or reserve, private landscaping should be sympathetic to and complement the public domain landscaping in order to soften the public-private interface.
- (e) Existing significant public views and vistas available from the public domain, including but not limited to ocean, city and parks views are to be maintained where possible by the design of buildings.
- (f) In some instances a detailed view loss analysis may be required by Council. Refer to the *Waverley Development Application Guide* for more information.
- (g) Measures to be used to facilitate view sharing include buildings setbacks, gaps between buildings, floor heights, roof forms and use of open materials and balustrades on balconies and decks.

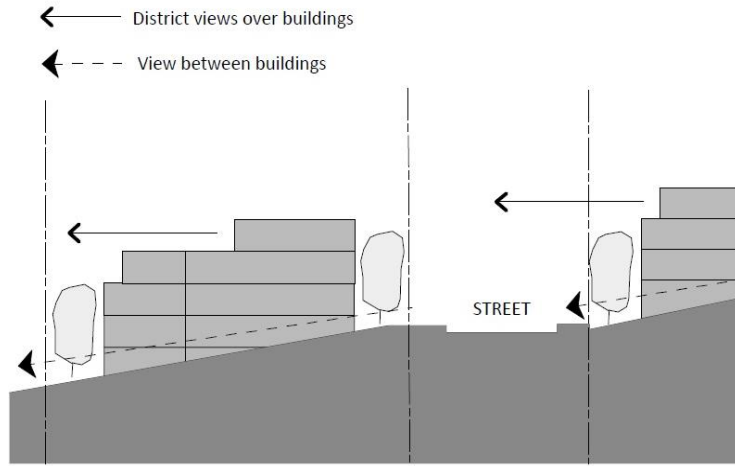


Figure 23 Views over buildings

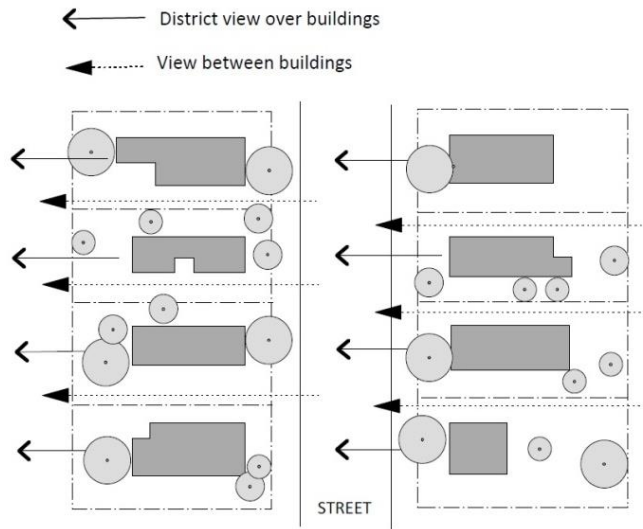


Figure 24 Views between buildings

## 2.15 VISUAL PRIVACY AND SECURITY

Privacy is important for residential amenity. The enjoyment of a residential property by its occupants relies on achieving a reasonable level of acoustic and visual privacy.

Roof-top terraces are discouraged in areas outside Dover Heights.

### Objectives

- (a) To ensure residential amenity is provided within and between developments.
- (b) To maximise outlook and views from principal rooms and private open space without compromising visual privacy.
- (c) To ensure buildings are safe and secure for residents and visitors.
- (d) To minimise adverse impacts of roof-top terraces.

### Controls

- (a) Dwellings should be oriented towards the street with entrances and street numbering clearly visible.
- (b) Development should be designed to provide clear sightlines and lighting between public and private places.
- (c) Development comprising 50 or more dwellings must be designed having regard to Crime Prevention through Environmental Design (CPTED) principles (refer to *B10 Safety*). Council may also require consideration of these principles for other large scale development (refer to the NSW Governments *Crime Prevention and the Assessment of development Applications – Guidelines* under section 4.15 of the *EP&AA 1979* for details).
- (d) Above ground open spaces must not directly overlook rooms and private landscaped areas of adjoining properties unless screening can mitigate overlooking. This includes:
  - (i) offset windows of dwellings in new development and adjacent development,
  - (ii) recess balconies and/or provide vertical fins between adjacent balconies; provide solid or semi-solid balustrades to balconies where necessary;
  - (iii) provide louvres or screens to windows/balconies where necessary;
  - (iv) use vegetation as a privacy screen between buildings;
  - (v) incorporate planter boxes into walls or balustrades to increase the visual separation between areas, and
  - (vi) utilise pergolas or shading devices to limit overlooking of lower dwellings or private open space.
- (e) Privacy needs to be considered in the context of density, separation, use and design and should consider the following principles from LEC decision *Meriton vs. City of Sydney Council (2004) NSWLEC 314*.
- (f) Windows and balconies of an upper level dwelling should be designed to prevent overlooking of more than 50% of the private open space of a lower level dwelling directly below and within the same development. Development may :
  - (i) screen balconies from other balconies and ground level private open space, separate communal open space;
  - (ii) common areas and access routes through the site from the windows of habitable rooms; and

- (iii) change the level between ground floor private courtyards and adjacent communal/public areas.
- (g) Landscaping should not be relied on as the sole protection against overlooking.
- (h) In areas undergoing change, the impact on what is likely to be built on adjoining sites, as well as the existing development, should be considered.
- (i) Roof tops may be used as trafficable roof-top terrace areas to meet communal open space requirements for residential flat building, mixed use and shop top housing development provided the following requirements are met:
  - (i) The rooftop will not result in unreasonable amenity impacts such as overlooking and unacceptable noise;
  - (ii) The trafficable area is distanced from the edge of the rooftop with permanent planter boxes or the like of sufficient size to mitigate unreasonable overlooking;
  - (iii) They satisfy the considerations of the Privacy Planning Principle from *2Super Studio v Waverley Council* [2004] NSWLEC 91 at 5-7;
  - (iv) Access hoods and stairs should be designed and sited to avoid obstructing views and producing adverse visual impacts.
  - (v)
  - (vi) The development does not contain a boarding house, co-living development or tourist and visitor accommodation; and
  - (vii) Other controls within this Part C2 are met.

**2.16 DWELLING SIZE AND LAYOUT**

**ADG Development: refer to Part 4D of the ADG.**

**Objectives**

- (a) To provide a diversity of dwelling sizes and layouts to cater for a range of household types.
- (b) To ensure that the internal arrangements of dwellings is functional and satisfies occupants needs.
- (c) To ensure dwellings provide high standards of residential amenity.
- (d) To encourage adaptive re-use and flexibility in design.

**Controls**

- (a) The maximum habitable room depth for a single aspect dwelling should be limited in depth to 8m from a window.
- (b) The width of a dwelling over 15m deep is to be 4m or greater to encourage natural light into living spaces.
- (c) All habitable rooms are to have a window for daylight and natural ventilation.
- (d) Developments are to provide dwelling types and sizes that contribute to a range of housing choice and affordability for the locality.
- (e) The following sizes are considered appropriate as a guideline:
  - (i) Studio – 35m<sup>2</sup>
  - (ii) 1 bedroom – 50m<sup>2</sup>
  - (iii) 2 bedroom – 80m<sup>2</sup>
  - (iv) 3+ bedroom – 100m<sup>2</sup>
- (f) Consideration should be given to the internal design of dwellings to encourage flexibility of uses over time.
- (g) Developments are to comply with the provisions set out in *Part B6 Accessibility and Adaptability* of this DCP.

**2.17 CEILING HEIGHTS**

**ADG Development: refer to Part 4C of the ADG.**

**Objectives**

- (a) To ensure residential amenity within dwellings and create spatial interest and variation.
- (b) To increase the sense of space in dwellings and provide well-proportioned rooms.
- (c) To promote penetration of daylight into all areas of each dwelling.
- (d) To contribute to flexibility of use.

**Controls**

- (a) Ceiling heights of dwellings must encourage the penetration of natural sunlight into all areas of the building. The following floor to ceiling heights are to be provided:
  - (i) 2.7m minimum for all residential floors; and
  - (ii) 2.4m minimum for attic levels.



**2.18 STORAGE**

**ADG Development: refer to Part 4G of the ADG.**

**Objectives**

- (a) To provide adequate and accessible enclosed storage for everyday household items.
- (b) To provide storage for sporting, leisure, fitness and hobby equipment.

**Controls**

- (a) *In addition to* kitchen cupboards and bedroom wardrobes, development must provide accessible and enclosed storage within the dwelling at the following cubic rates:
  - (i) Studio & one bedroom dwellings – 6m<sup>3</sup>
  - (ii) Two bedroom dwellings – 8m<sup>3</sup>
  - (iii) Three plus bedroom dwellings – 10m<sup>3</sup>
- (b) Each dwelling is to have access to a bulky storage area. This may be outside, within a basement or ancillary structure. This area is to be separate and secure for each dwelling.

## 2.19 ACOUSTIC PRIVACY

Acoustic privacy is a measure of sound insulation between dwellings and between external and internal spaces. Designing for acoustic privacy relates to the location and separation of buildings within a development and the arrangement of dwellings and internal spaces within dwellings.

### Objective

- (a) To ensure a high level of amenity for residents.
- (b) To effectively manage the interface between non-residential uses and residential accommodation.

### Controls

- (a) Soundproofing of all dwelling units by such means as acoustic glazing is required to reduce noise impacts on residents.
- (b) Minimise noise transmission between dwellings by:
  - (i) Locating noisy and quieter areas next to other noisy or quiet areas, e.g. living rooms adjacent to living rooms, and bedrooms adjacent to bedrooms.
  - (ii) Using storage or circulation zones within an dwelling to buffer noise from adjacent dwellings, mechanical services or corridors and lobby areas and minimising the amount of party (shared) walls with other dwellings.

**2.20 NATURAL VENTILATION****ADG Development: refer to Part 4B of the ADG.****Objective**

- (a) To ensure dwellings are designed to provide all habitable rooms with direct access to fresh air and to assist in promoting thermal comfort for occupants.
- (b) To encourage the design of the development to address orientation, building envelope and the internal configuration of dwellings.
- (c) To provide natural ventilation in non-habitable rooms, where possible.
- (d) To reduce the use of mechanical ventilation, particularly air-conditioning.

**Controls**

- (a) All dwellings in a development are to be naturally cross-ventilated. These may be either dual aspect (e.g. cross through dwellings and corner dwellings), or maisonette/2 storey dwellings which draw cool air in at lower levels and allow warm air to escape at higher levels.
- (b) Plan the site to utilise natural breezes by:
  - (i) Determining prevailing breezes and orienting buildings to maximise access to breezes, where possible;
  - (ii) Locating vegetation to direct breezes and cool air as it flows across the site; and
  - (iii) Selecting and planting trees that do not inhibit airflow.
- (c) Design the internal dwelling layout to promote natural ventilation by minimising interruptions (such as corners and walls) to air flow through a dwelling.
- (d) Doors and operable windows are to maximise natural ventilation by:
  - (i) Locating small windows on the windward side and larger windows on the leeward side of the building, allowing air pressure to draw air through the dwelling;
  - (ii) Using higher level casement or sash windows, clerestory windows or operable fanlight windows to facilitate convective currents; and
  - (iii) Selecting windows which can be reconfigured to funnel breezes into the dwelling.
- (e) Innovative technologies to naturally ventilate internal rooms such as laundries, bathrooms and basement car parks are to be implemented including stack-effect ventilation or solar chimneys.
- (f) To minimise use of air-conditioning, all dwellings must have ceiling fans installed in all habitable rooms.

## 2.21 BUILDING SERVICES

### Objective

- (a) To provide and integrate site services and facilities in a sensitive manner such that they relate to the building and landscape design, enable easy access, and require minimal maintenance.
- (b) To minimise visual impact by encouraging building services to be located in the basement of buildings, where practicable.
- (c) To ensure that adequate space and facilities are provided to allow the natural drying of clothes and the provision of compost facilities.

### Controls

- (a) Ensure that building services are integrated into the design of buildings. Building service elements include garbage rooms, mailboxes, fire hydrant boosters, electrical substations, downpipes, and plant rooms and satellite/communications structures.
- (b) The maximum volume permitted for a plant room is the minimum required to meet Australian Standards, accommodate typical dimensions of equipment required and the associated circulation space to access the equipment for maintenance. Plant rooms should be located in underground areas where possible. DA plans should show the approximate location and size of equipment within the plant room.
- (c) Provide mailboxes adjacent to the main entrance and integrated into a wall of the building where possible, ensuring that they are secure and can accommodate large articles such as newspapers.
- (d) Coordinate and integrate building services within the overall façade and roof design.
- (e) Provide adequate space and facilities for outdoor communal clothes drying.
- (f) Locate any ancillary structures such as plant rooms and satellite dishes away from the building entry, communal and private open spaces, and bedrooms.
- (g) Where located on podium or roof levels, building service elements must not be visible from the street or impact on public or private views. As a guide, a minimum of 2m is to be provided from the building wall. (Refer to Figure 25).

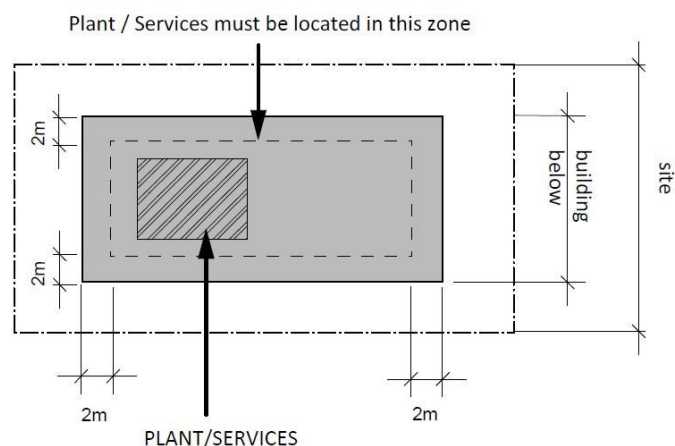


Figure 25 Plant and services zone

## 2.22 RETENTION OF AFFORDABLE RENTAL HOUSING

When a development site contains an existing residential flat building or an existing boarding house Chapter 2 Part 3 of the *State Environmental Planning Policy (Housing) 2021* (Housing SEPP) is relevant for consideration.

### Objective

- (a) To ensure that applicable Development Applications can be accurately assessed under the Housing SEPP.

### Controls

- (a) When a development site contains an existing residential flat building or an existing boarding house, the Statement of Environmental Effects report submitted with a DA is to include an assessment against Chapter 2 Part 3 of the Housing SEPP.
- (b) Where 5-years' worth (counted back from the date of lodgement) of rental data is provided by the applicant to confirm whether a dwelling is or is not a low-rental dwelling as defined by the Housing SEPP, the data should be provided in one of the following two ways:
  - a. Executed leases and rental increase or decrease letters; or
  - b. Information from the leasing agent accompanied by an executed statutory declaration.

Without rental data being provided in one of these two forms it will be assumed that the dwellings without such data are low-rental, as it cannot be reliably proven otherwise.

Where a dwelling is identified by the applicant as being owner-occupied for all or some of the 5-year period, a statutory declaration confirming such as well as a copy of a utility bill from every 6 months that the dwelling was owner-occupied should be provided.

Where Council are not satisfied with the rental data, further information may be requested.

# PART D COMMERCIAL DEVELOPMENT

## Contents

<b>D1</b>	<b>COMMERCIAL AND RETAIL DEVELOPMENT</b>	<b>245</b>
1.1	Other Policies, Strategies and Standards	245
1.2	Design	246
1.3	Hours of Operation	248
1.4	Restricted Premises	251
<b>D2</b>	<b>OUTDOOR DINING</b>	<b>252</b>
2.1	Location	252
2.2	Furniture and Accessories	254
2.3	Management	257
2.4	Designated Footpath Seating Locations	260
<b>ANNEXURES</b>		<b>269</b>

**D1 COMMERCIAL AND RETAIL DEVELOPMENT**

This Part applies to commercial and retail premises throughout Waverley.

**1.1 OTHER POLICIES, STRATEGIES AND STANDARDS**

Applicants are to ensure that the proposed development is in compliance with the relevant Australian Standards, including:

- The *National Construction Code* (NCC)
- Australian Standard *AS/NZS 1158 3.1:2005 Pedestrian (P) Lighting*
- The *Food Act 2003*
- The *Food Standards Code*
- The *Noise Guide for Local Government*
- The *Protection of the Environment and Operations Act 1997*

## 1.2 DESIGN

### Objectives

- (a) To encourage a range of uses to service the local community as well as regionally.
- (b) To encourage development to be designed to have an engaging interface between the private and public domain, with a high level of amenity.
- (c) To encourage surveillance over the public domain.
- (d) To enhance the scenic quality and amenity of streetscapes and public places.
- (e) To ensure operations are compatible with adjoining residential uses and are in accordance with the amenity expectations of the subject site and locality's zoning(s).
- (f) To effectively manage the interface between non-residential uses and residential accommodation.

### Controls

#### 1.2.1 Frontages

- (a) Front windows shall be designed to promote an active street frontage and have a display function (refer to *Part B16 Public Domain*).
- (b) The development is to be designed to provide casual surveillance to the street.
- (c) The use of obscured glazing is generally not supported. Privacy louvres and screens are preferred which allow partial views into a premises. Where privacy is required, obscured glazing may be provided at the rear of the premises.
- (d) Window and door frames and styles should reflect the character of the building and area.
- (d) Premises are required to display a street number. The height of the numbers will be no less than 300mm presented in a clear readable font, located above the entry door, where possible.

#### 1.2.2 Awnings

- (a) Premises are to provide a continuous awning, except where an awning would compromise the integrity of a heritage item.
- (b) Awnings are to be designed in accordance with the building age, style and character, and be sympathetic to the design of adjoining awnings.
- (c) Awnings are to match the alignment and style of adjoining buildings to provide continuous weather protection.
- (d) Development must also comply with the relevant provisions of *Part B16 Public Domain*.

#### 1.2.3 Lighting

- (a) Under awning lighting is to be provided.
- (b) Fluorescent lighting is discouraged.
- (c) Where residential development is located above retail or commercial premises or to the rear, demonstrate that light is not directed toward the residents of the building.



- (d) Illumination at the rear of commercial properties or where installed for security purposes must be sensor controlled, except where public street frontage and/or footpaths require it.
- (e) Development is to minimise negative impacts of lighting from within the premises on nearby properties.

---

### 1.2.4 General Amenity

- (a) The design and use of the building is to take into consideration any impact on surrounding residential uses and include mitigation measures where necessary.
- (b) Development shall incorporate plant rooms and any associated services required for the use of the premises into the building envelope. Where this cannot be achieved in an existing development, plant room/utilities are to be designed to cause negligible impact to neighbouring properties and streetscape.
- (c) All new development shall be designed to include an internal ventilation shaft to ensure future alterations do not place the shaft in an unsuitable location.
- (d) No goods shall be placed on the footpath without Council consent.

---

### 1.2.5 Noise

- (a) An acoustic report may be required for noise generating uses to demonstrate that noise will be appropriately attenuated between buildings.
- (b) Air conditioning units and cool-room equipment must be located in a plant room or acoustic enclosure.
- (c) Speakers should be located and orientated to minimise noise levels to neighboring properties.
- (d) The design of the premises shall insulate adjoining/nearby properties from any noise or vibration levels caused by the use of the premises.

**1.3 HOURS OF OPERATION**

**Objectives**

- (a) To ensure trading does not impact on the amenity of the area or disrupt nearby residential properties.
- (b) To outline the application of trial periods of extended trading hours.

**Controls**

- (a) Pre-works and clean-up of the premises (**operational hours**) can exceed the maximum approved **trading hours** up to a maximum of one hour before and one hour after trading hours, provided trading does not occur within this time.
- (b) Where an application is received for the refurbishment of an existing licensed premises without trading hours regulated by a condition of consent, a new condition of consent will be imposed in accordance with this Part to regulate trading hours of the premise.
- (c) Deliveries and the operation of loading docks shall be limited to the approved trading hours depending on the use and nearest residential properties.
- (d) The prescribed trading hours within Table 1 are subject to all other aspects of the development being satisfactory. Where residential uses are in close proximity, more restrictive trading hours may be applied.

ZONE	Trading Hours
All residential zones	(a) General base trading hours: (i) 7.00am to 10.00pm, 7 days a week  (b) Extended trading hours on a 1 year trial basis will be considered up to 6.00am to 11.00pm, Fridays and Saturdays only.
CENTRE NAME - see Part E for maps	Trading Hours
Bondi Junction (MU1 Zone portions)	(a) General base trading hours: (i) Monday to Saturday: 7.00am to 11.00pm; and (ii) Sunday: 7.00am to 10.00pm.  (b) Extended trading hours on a 1 year trial basis will be considered up to: (i) Monday – Sunday: 6.00am to midnight.
Bronte Road, Bondi Junction	
Bondi Beach	
Bondi Road	
Rose Bay North	
Charing Cross Curlewis Street Rose Bay South	
Bondi Junction (E2 Zone portions)	(a) General base trading hours: (i) Monday to Saturday: 7.00am to 11.00pm; and

	<ul style="list-style-type: none"> <li>(ii) Sunday: 7.00am to 10.00pm.</li> <li>(b) Extended trading hours on a 1 year trial basis will be considered up to:                             <ul style="list-style-type: none"> <li>(i) Sunday to Wednesday: 6.00am to midnight; and</li> <li>(ii) Thursday, Friday and Saturday: 6.00am to 1.00am.</li> </ul> </li> </ul>
Macpherson Street	<ul style="list-style-type: none"> <li>(a) General base trading hours:                             <ul style="list-style-type: none"> <li>(i) 7.00am to 10.00pm, 7 days a week.</li> <li>(b) Extended trading hours on a 1 year trial basis will be considered up to:                                     <ul style="list-style-type: none"> <li>(i) 11:00pm on Thursdays, Fridays and Saturdays only; and</li> <li>(ii) Monday – Sunday from 6.00am.</li> </ul> </li> </ul> </li> </ul>
Wairoa Avenue	
North Bondi	
Seven Ways	
Bronte Beach	
Belgrave Street	
Flood Street	
Murriverie Road	
OSH Road, at Murriverie Road	
Vaucluse	
Blake Street	
Fletcher Street	

**Table 1** Hours of operation

**1.3.1 Extended Trading Hours**

- (a) Council recognises that a number of uses may require longer trading hours than outlined in Table 1, particularly earlier opening times. In these instances, an application to extend or modify trading hours will undergo an additional merit assessment.
- (b) Extended trading hours will be considered on a temporary basis, to enable Council to assess the ongoing management performance of the premises and the impact on the neighbourhood amenity.
- (c) New premises must operate for a minimum of 6 months before an application for extended trading hours can be lodged.
- (d) Extended trading hours may initially be granted for a 1-year fixed term.
- (e) Following the completion of a satisfactory fixed term, a reviewable term may be permitted as follows:
  - (i) First reviewable term – up to a maximum of 2 years.
  - (ii) Second reviewable term – up to a maximum of 3 years.
  - (iii) Third and subsequent terms – up to a maximum of 5 years.

### 1.3.2 Review of Extended Trading Hours

- (a) Council's assessment of extended trading hours will consider the following:
  - (i) The location of the premises, including proximity to residential and other sensitive land uses;
  - (ii) The specific use of the premises, i.e. pub, nightclub, restaurant. Licensed premises are not eligible for extended trading hours on Sunday nights;
  - (iii) The existing hours of operation of surrounding business uses;
  - (iv) Size and patron capacity of the premises;
  - (v) Security and general management of the premises;
  - (vi) Number and nature of substantiated complaints regarding the operation of the premises;
  - (vii) Compliance with conditions of consent;
  - (viii) Evidence that the applicant has taken a pro-active position in terms of industry best practice;
  - (ix) Record of successful waste management on site and clean up and management of waste in adjacent public domain;
  - (x) Length of time the premises has traded under current operator;
  - (xi) Availability of transport for patrons including taxis, buses and car parking areas; and
  - (xii) Any other matters considered relevant to the environmental evaluation of the premise.
- (b) Applications for a reviewable term are to be lodged between 6 months and 3 months before the end date of the current term.
- (c) If an application is lodged within the time frame specified in (b) but is not determined by the end date of the current term, the premises can continue to operate as per the current term hours until the application is determined.
- (d) If Council determines no further extension period shall be granted the premises must revert to its approved base hours.
- (e) If the operator of the premises changes, the extended trading hours may be returned to a fixed term of 1 year.

## 1.4 RESTRICTED PREMISES

Restricted premises and sex services premises are permitted within the E2 Commercial Centre Zone under WLEP. The WLEP includes specific controls relating to sex services premises.

This Part provides additional controls relating to sex service premises and restricted premises to ensure their design and location does not negatively impact on the surrounding neighbourhood.

### Objectives

- (a) To ensure restricted premises are compatible with the surrounding uses and character of the area.
- (b) To ensure the design, operation and location are appropriate and the cumulative impacts of commercial uses on the surrounding area are minimised.

### Controls

- (a) Where a proposed development includes a restricted premises, sex services premises or licensed premises, the following details must be taken into consideration in the assessment of the proposal:
  - (i) The nature and operation of the proposed uses;
  - (ii) Measures to be used for ensuring adequate safety, security and crime prevention both on the site of the premises and in the public domain immediately adjacent to, and generally surrounding the premises;
  - (iii) Proposed hours of operation;
  - (iv) The size and intensity of the proposed development having regard to the number of people who will work on the premises;
  - (v) Proposed management;
  - (vi) Whether the use is proposed to be licensed;
  - (vii) Whether live entertainment is proposed;
  - (viii) The proximity, location and impact of the proposed uses on schools, places of worship, community facilities, major transport, residential buildings and places frequented by children; and
  - (ix) The likely impact on the amenity and desired future character of the street and area.
- (b) No internal rooms or spaces of the sex services premises, other than an access corridor to the premises are to be visible from a public space or shopping arcade.
- (c) No merchandising display relating to the restricted premises is to be erected, or displayed in the access corridor so as to be viewed from a public open space.
- (d) Signage for sex service premises is to be limited to the address or street number.
- (e) To ensure the restricted premises remains discrete, no flashing or illuminated signage is permitted for restricted premises.

## D2 OUTDOOR DINING

This Part guides applicants seeking approval to utilise footpath areas outside their café or restaurant for footpath seating, as well as developments that include outdoor courtyards.

Where proposals are partly or fully on public land within the Waverley LGA, development consent and approval under Section 125 of the *Roads Act 1993* is required. This Part specifically addresses footpath seating only. Applications seeking approval for footpath seating are required to submit the Footpath Seating Application form with the DA.

The display of goods on the footpath and/or temporary or movable advertising signs on the footpaths requires separate approval from Council as part of an 'Activity Application'.

Cafes and restaurants wishing to serve alcohol are required to apply for a separate license under the *Liquor Act 2007*.

### 2.1 LOCATION

Footpath seating can make a significant contribution to the quality of the public spaces by providing an active street frontage. However footpath seating may not be appropriate in all locations due to safety and amenity issues.

To be eligible for a footpath seating license the primary function of the premises must be a café, restaurant or food and beverage provider and must:

- Provide sit down meals or snacks;
- Utilise non disposable eating utensils;
- Have washing up facilities for all cooking/eating utensils; and
- Provide waiter service for all patrons.

#### Objectives

- (a) To ensure pedestrian footpath movements are maintained, as well as the safety of patrons and staff.
- (b) To ensure footpath café and restaurant seating is not the primary dining area but an extension of indoor seating for use in fine weather.
- (c) To ensure that footpath dining is provided to premises where the primary purpose is the consumption of food.

#### Controls

- (a) When assessing applications consideration will be given to:
  - (i) The convenience and safety of pedestrian movement;
  - (ii) The safety of vehicular movement;
  - (iii) Any impact on residential amenity;
  - (iv) Whether the application contributes to and improves the local amenity and the public domain; and

- (v) The impact on the existing natural environment including existing trees, significant views and items of heritage significance.
- (b) The standard location for the footpath café/restaurant seating is against the shop front. Where this location would interrupt a continuous path of travel for pedestrians, locate seating to maintain a continuous path of travel.
- (c) If adjoining space is not used by the adjacent shop, shops immediately adjacent may take up that space providing they meet the criteria for approval in this Part. Adjoining space should only be used as long as the adjacent business does not require the seating for their own purposes. Owner's consent to use the area in front of an adjoining tenancy can be cancelled by that owner or Council with a minimum 4 weeks' notice.
- (d) Where the footpath seating is adjacent to the kerb a standard minimum setback of 1.5m from the kerb is required to allow access to parked cars and to ensure the safety of patrons.
- (e) Footpath seating and associated furniture must be kept clear of street corners to allow adequate visibility and sight lines for traffic safety. Allow a 45 degree splay from the corner of the building.
- (f) Where a footpath is extended at a street corner or where there is a road closure there may be opportunities for different seating locations other than the standard footpath seating location.
- (g) Alternative footpath seating locations may be considered on their merits. Additional supporting information must be provided with the application including evidence illustrating how pedestrian and vehicular safety will be achieved.
- (h) The minimum dimensions of 600mm x 600mm per seat and 600mm x 600mm per table is required.
- (i) Adequate circulation space for patrons and staff within the footpath seating area must be provided.
- (j) The minimum width of a clear unobstructed pedestrian footpath is 2.5m. This distance is exclusive of street furniture, bus stops, disabled parking spaces, parking meters, telephone boxes or the like.
- (k) No furniture is to be located within 3m of a bus stop or taxi to allow for adequate pedestrian circulation.
- (l) Where footpaths do not have adequate width to accommodate the required minimum unobstructed pedestrian footpath and footpath seating widths, shops are encouraged to provide shop fronts capable of opening to the street.
- (m) All areas granted approval for outdoor seating must clearly mark the location of the space on the pavement with Council approved markers.
- (n) Exceptions are for the following designated footpath seating areas:
  - (i) Oxford Street Mall; Bondi Junction
  - (ii) Waverley Street Mall, Bondi Junction;
  - (iii) Campbell Parade, Bondi Beach, between Lamrock Avenue and Beach Road;
  - (iv) Roscoe Street, Bondi Beach; and
  - (v) Bronte Road, Bronte Beach.

\*Refer to *Part D2.4 Designated Footpath Seating* for area specific controls.

## 2.2 FURNITURE AND ACCESSORIES

Outdoor footpath should make a positive contribution to the street environment and be of a style that is practical and that integrates into the surrounding area.

### Objectives

- (a) To ensure all furniture and accessories are high quality and an appropriate design.

### Controls

- (a) All furniture must be safe, strong, durable, waterproof, weather resistant and salt resistant. All furniture must be purpose built and designed for commercial outdoor use.
- (b) Elements of furniture (such as chairs, tables, barriers or umbrellas) must be uniform in style and design within each café or restaurant in order to maintain a cohesive pattern and legible groupings.
- (c) Barriers are encouraged at either end of the outdoor seating to enable pedestrians to navigate a safe and continuous path of travel.
- (d) All furniture must be kept well maintained and clean at all times. Council reserves the right to require replacement of inappropriate and/ or hazardous furniture as a license requirement.
- (e) All furniture, accessories and umbrellas are temporary and must be stored away from footpath seating areas outside the approved hours of operation unless specific approval has been granted.
- (f) Milk crates and the like are not allowed.
- (g) Adequate toilet facilities are to be provided in commercial premises to comply with the BCA.
- (h) Adequate mobile waste bins are to be provided to prevent litter. Bins are to be stored within the premises outside of operating hours.

---

### 2.2.1 Accessories

- (a) Provide wind proof menus and sugar containers.
- (b) Pedestal menu boards and A-frame or sandwich board menus are to be transportable, kept within occupied areas at all times during use and not obstruct pedestrian thoroughfares.

---

### 2.2.2 Umbrellas

- (a) Umbrellas are to be commercial grade and suitable for outdoor use (UV resistant, provide rain and hail protection, fire resistant, wind rated and easily maintained) of a square canopy shape with no top hat, have a diameter of between 1.8m and up to 4.0m, have a centre post, be collapsible and be at least 2.2m above ground when open.
- (b) Umbrellas must be removed or closed in extreme windy conditions to avoid damage and ensure safety for patrons and pedestrians.
- (c) Umbrella bases must not damage the paving and should be secured to the umbrella.



- (d) Umbrellas are to be securely anchored by the applicant to the satisfaction of Council. The cost of the umbrellas and securing them will be borne by the applicant.
- (e) The umbrella base may be embedded in the footpath paving with Council approval.
- (f) Umbrellas may overhang a maximum of 300mm outside the approved footpath seating area.
- (g) Umbrellas may not be fitted with protection blinds unless specific approval has been granted.
- (h) Umbrellas must be cleaned at least once every 12 months at the cost of the applicant.

---

**2.2.3 Barriers and landscape planters**

- (a) The maximum permitted dimensions of a barrier is 900mm high and 1.2m wide.
- (b) The maximum permitted dimensions of a planter is 750mm high, 1.2m wide and 900mm deep.
- (c) No barriers or landscape planters are permitted in Oxford Street Mall or Waverley Street Mall.
- (d) Barriers and landscape planters are not permitted in front of the seating area facing the pedestrian way.
- (e) Third party advertising is not permitted on barriers.

---

**2.2.4 Heaters**

- (a) Only tall, free standing, portable radiant gas heaters are permitted.
- (b) Heaters used in footpath seating areas must be:
  - (i) Commercial grade only;
  - (ii) Well maintained for safety;
  - (iii) Able to turn off automatically if overturned;
  - (iv) Removed from the footpath seating area and stored on private property when not in use unless approval is granted; and
  - (v) Not attached to an umbrella.

---

**2.2.5 Lighting**

- (a) Any footpath seating which will be operating outside daylight hours must provide adequate lighting to Council's satisfaction, to ensure the safety and amenity of patrons, staff and the general public.
- (b) Any additional lighting required must be temporary and must be stored away from footpath seating areas outside the approved hours of operation.
- (c) Wiring or cables that is above ground or that crosses the public domain is not permitted.
- (d) Lighting should not cause light to spill in to habitable living areas of adjacent residential buildings.

---

**2.2.6 Advertising and Logos**

- (a) Only the name and/or logo of the tenant is permitted on furniture. No third party advertising is permitted.

- (b) The name and/or logo are to be presented on a maximum one third of an umbrella panel.
- (c) Third party advertising is not permitted on barriers.

## 2.3 MANAGEMENT

To ensure that footpath seating and outdoor courtyards contribute positively to the urban environment it is necessary to ensure that the appropriate management issues are considered including noise, hours of operation, health and safety.

### Objective

- (a) To ensure the operation of footpath seating and outdoor courtyards does not have an adverse impact to the amenity of adjoining and nearby properties and residents.
- (b) To ensure that footpath furniture only occupies space within licensed areas.

### Controls

- (a) Management is responsible for keeping public areas surrounding the approved seating area clear of prams and dogs associated with their customers. Where customers with prams are regular clientele, consider providing a 'pram' table with extra space around it for prams, or collapsible chairs which can easily be removed to give more space for prams within the seating area.
- (b) Provision is to be made for a waiter station when footpath seating is for more than 30 persons.
- (c) The approved footpath seating area is to be delineated with corner markers in the footpath using Council approved pavement markers.
- (d) Seating areas must be kept clean and free of litter during operating hours.
- (e) Litter patrol documentation in the form of a cleanup roster must be kept on site at all times.
- (f) Seating areas must be clean and free of litter once furniture and accessories are removed from the public realm after hours.
- (g) Where a permit is suspended, relocated, amended and/or cancelled, neither the permit holder nor any other persons shall be entitled to any payments, compensation or damages of any kind from Waverley Council.
- (h) The proprietor is to ensure that the requirements of the *Food Standard Code* are fully met.
- (i) No Smoking is permitted in footpath seating areas.

### 2.3.1 Hours of operation and noise

- (a) Hours of operation must finish at least half an hour before the general operational hours of the establishment as determined by Council.
- (b) In addition to (a), footpath seating (including renewal of existing footpath seating) or the operation of outdoor courtyards is not to occur outside of the hours in Table 2.
- (c) Footpath seating or use of an outdoor courtyard will not be approved if the proposal is of a scale that noise generated will have a significant adverse effect upon nearby residential properties.
- (d) Amplified sound emanating from public footpaths or projected onto public footpaths is not permitted.
- (e) Notwithstanding the hours outlined in table 2, extended hours may be granted only on a trial and reviewable basis where the proprietor can demonstrate:

- (i) There is a need for longer hours to more closely align with the approved operating hours of the premises, and
  - (ii) The premises has not generally been subject to complaints relating to noise and overall operation, and
  - (iii) The additional period will not cause or result in adverse amenity impacts on the neighbourhood.
- (f) Extended dining hours will not exceed 10pm in any case and any approval will be subject to a reviewable condition.

ZONE	Maximum Trading Hours
R3 Medium Density Residential Zone and R2 Low Density Residential Zone	<ul style="list-style-type: none"> <li>Monday to Saturday: 7.00am to 9.00pm; and</li> <li>Sunday: 7.00am to 9.00pm.</li> </ul>
CENTRE NAME - see Part E for maps	Maximum Trading Hours
Bondi Junction	<ul style="list-style-type: none"> <li>Monday to Saturday: 7.00am to 10.00pm; and</li> <li>Sunday: 7.00am to 9.30pm.</li> </ul>
Bronte Road, Bondi Junction	
Bondi Beach	
Bondi Road	
Rose Bay North	
Charing Cross	
Curlewis Street	
Rose Bay South	
Macpherson Street	<ul style="list-style-type: none"> <li>Monday to Saturday: 7.00am to 9.00pm; and</li> <li>Sunday: 7.00am to 9.00pm.</li> </ul>
Wairoa Avenue	
North Bondi	
Seven Ways	
Bronte Beach	
Belgrave Street	
Flood Street	
Murriverie Road	
OSH Road, at Murriverie Road	
Vaucluse	
Blake Street	

Fletcher Street	
-----------------	--

**Table 2** Footpath seating maximum hours of operation

### 2.3.2 Tenancy approvals

- (a) Generally, approval for footpath seating will be granted for 5 years inclusive of a 6 month trial period and checks made for compliance regularly throughout the approval period. Council may elect to approve for a lesser period of time, where it is of the opinion that the use of the footpath may cause detrimental impact to the amenity of the area.
- (b) A permit may be cancelled or amended if:
  - (i) The proprietor fails to comply with the permit conditions; and
  - (ii) There are changed conditions affecting the outdoor dining area in its particular location, such as increased risk to health and safety.
- (c) If payment of rent for outdoor seating is not received by Council on the first day of each month an approval is in place, the approval is considered to have lapsed until payment is received. In the interim, an infringement notice may be issued for obstructing the footpath without approval.
- (d) Tenants are required to keep their approved footpath seating layout plan in clear view so Waverley Council compliance officers can easily check for compliance with the approval at any time. Appropriate locations are in the front window or, if the front facade of the tenancy is fully openable, close to the front of the tenancy.
- (e) Tenants are required to pay a rental bond as determined in the agreement with Council.

### 2.3.3 Toilet and sanitary conveniences

- (a) Premises with seating capacity for 20 or more patrons must provide sanitary facilities in accordance with the requirements under the National Construction Code.

## 2.4 DESIGNATED FOOTPATH SEATING LOCATIONS

In addition to the general controls there are specific controls for the following designated footpath seating locations.

### Objectives

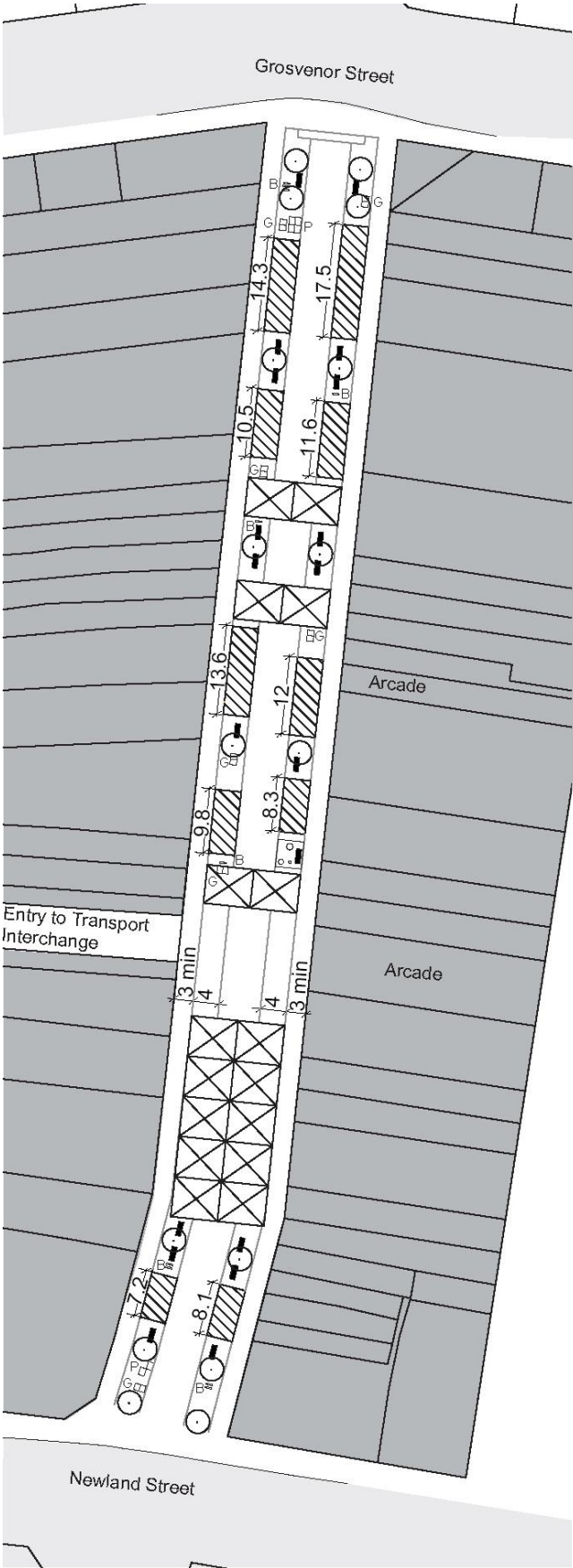
- (a) To ensure footpath seating contributes to and improves the local amenity and the public domain.
- (b) To ensure the existing natural environment including existing trees, significant views and items of heritage significance are maintained.

### Controls





---

#### 2.4.1 Oxford Street Mall, Bondi Junction

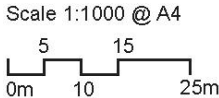
- (a) Oxford Street Mall is to have a minimum clear unobstructed pedestrian footpath of 3m.
- (b) Footpath seating in Oxford Street Mall is required to be located away from the shop fronts.
- (c) The location of footpath seating is to be in accordance with Map 1.
- (d) Footpath seating must be a minimum of 1.2m away from site furniture-bicycle racks, garbage bins, public seating, public telephones.
- (e) Council discourage the use of barriers and accessories.



**Map 1.** Oxford Street Mall, Bondi Junction

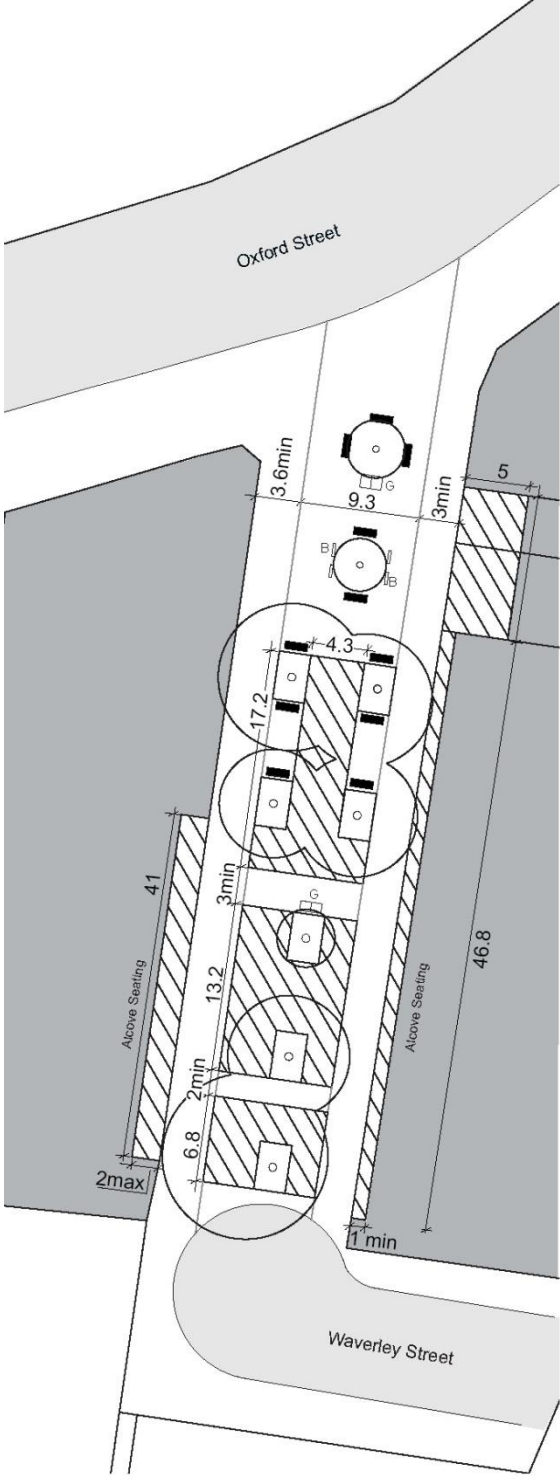
-  Designated Footpath Seating Area
-  Existing Public Seating
-  Tree Canopy Approx.
-  Shade Structure
- B** Bike Racks
- G** Garbage Bins
- P** Public Telephone

- Note**
- All dimensions in metres
  - Footpath seating must be a minimum of 1.2 metres away from site furniture-bicycle racks, garbage bins, public seating, public telephones



2.4.2 Waverley Street Mall, Bondi Junction

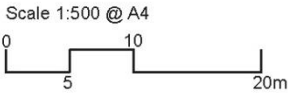
- (a) Waverley Street Mall is to have a minimum unobstructed pedestrian footpath of 2.0m, between the café/restaurant footpath seating against the shop front and the designated seating areas or planters.
- (b) Footpath seating is permitted against the shop fronts within alcove areas only and also in the designated seating areas located in Map 2.



Map 2. Waverley Street Mall, Bondi Junction

- Designated Footpath Seating Area
- Existing Public Seating
- Tree Canopy Approx.
- Existing Planters
- G Garbage Bins
- B Bicycle Racks

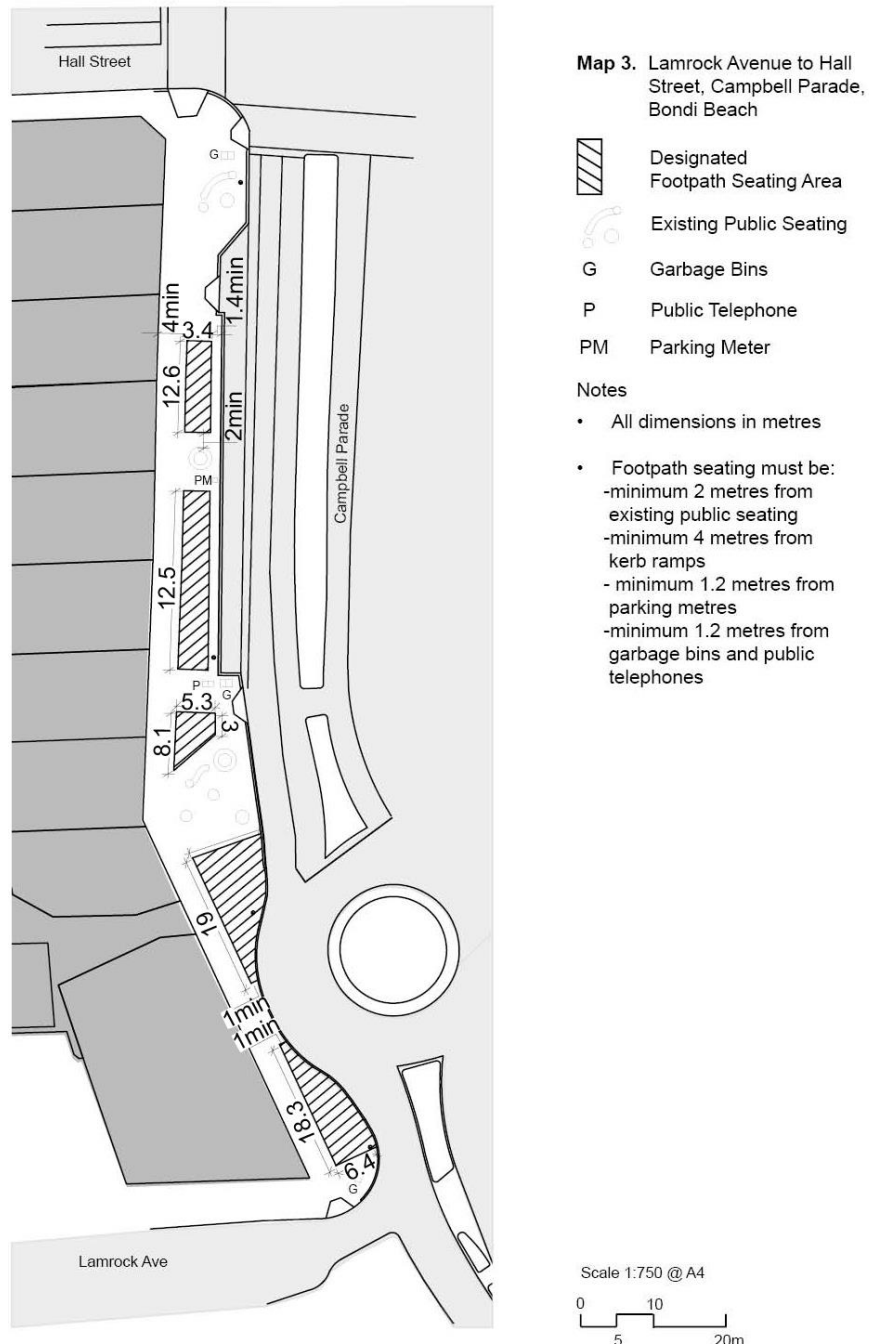
Note  
• All dimensions in metres

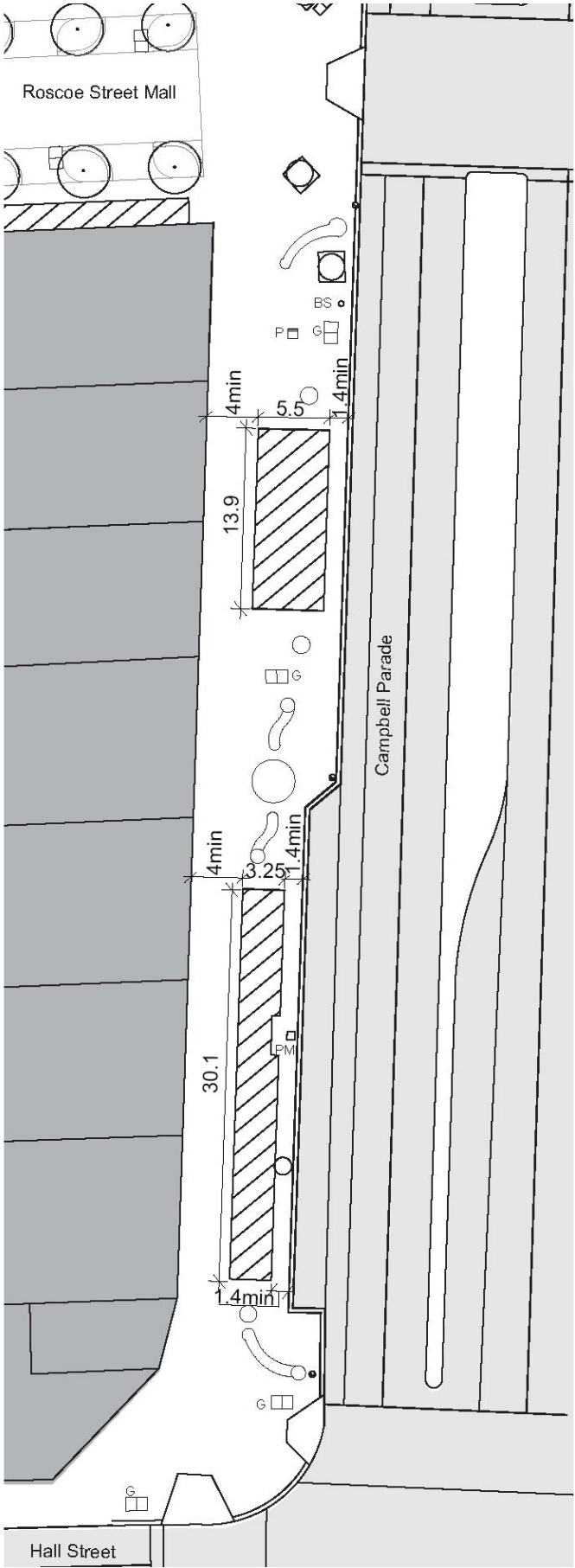











**2.4.3 Campbell Parade between Lamrock Avenue and Beach Road, Bondi Beach**

- (a) Campbell Parade is to have a minimum 4m clear pedestrian footpath between Lamrock Avenue and Beach Road (and minimum 2m in all other areas) as indicated on the designated footpath seating maps in Maps 3, 4, 5 and 6.
- (b) Footpath seating must be a minimum 2 metres from existing public seating, a minimum of 1.2 metres from parking metres, a minimum of 1.2 metres from garbage bins and public telephones.
- (c) Protective blinds are only permitted to a maximum of three sides of an umbrella. The blinds must not contain metal rods and must be rolled up when not in use.
- (d) All umbrellas must be embedded in the footpath paving on Campbell Parade between Lamrock Avenue and Beach Street.

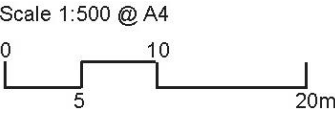


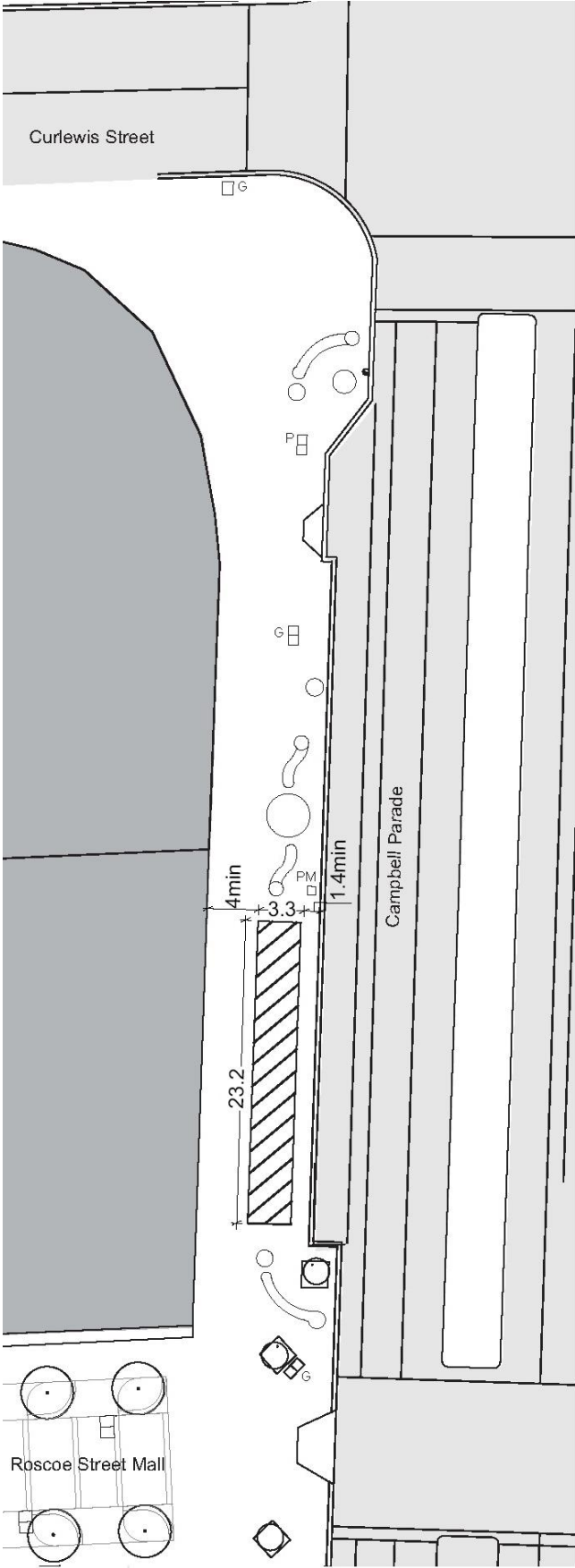


**Map 4.** Hall Street to Roscoe Street , Campbell Parade, Bondi Beach

-  Designated Footpath Seating Area
-  Existing Public Seating
-  Garbage Bins
-  Public Telephone
-  Parking Meter
-  Bus Stop
-  Tree Canopy Approx.

- Notes**
- All dimensions in metres
  - Footpath seating must be:
    - minimum 2 metres from existing public seating
    - minimum 1.2 metres from parking metres
    - minimum 1.2 metres from garbage bins and public telephones

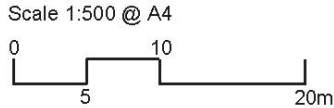


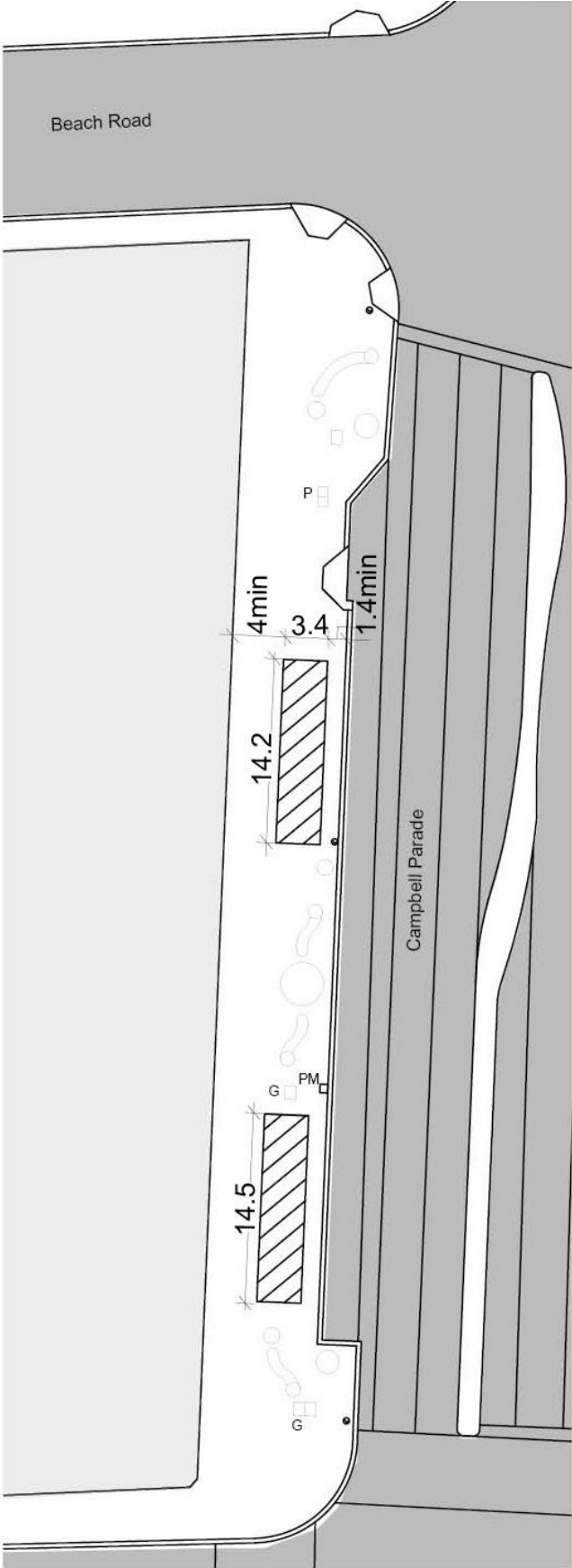


**Map 5.** Roscoe Street to Curlewis Street, Campbell Parade, Bondi Beach

-  Designated Footpath Seating Area
-  Existing Public Seating
- G Garbage Bins
- P Public Telephone
- PM Parking Meter
-  Tree Canopy Approx.

- Notes
- All dimensions in metres
  - Footpath seating must be:
    - minimum 2 metres from existing public seating
    - minimum 1.2 metres from parking metres
    - minimum 1.2 metres from garbage bins and public telephones

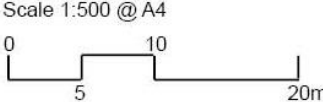




**Map 6.** Curlewis Street to Beach Road, Campbell Parade, Bondi Beach

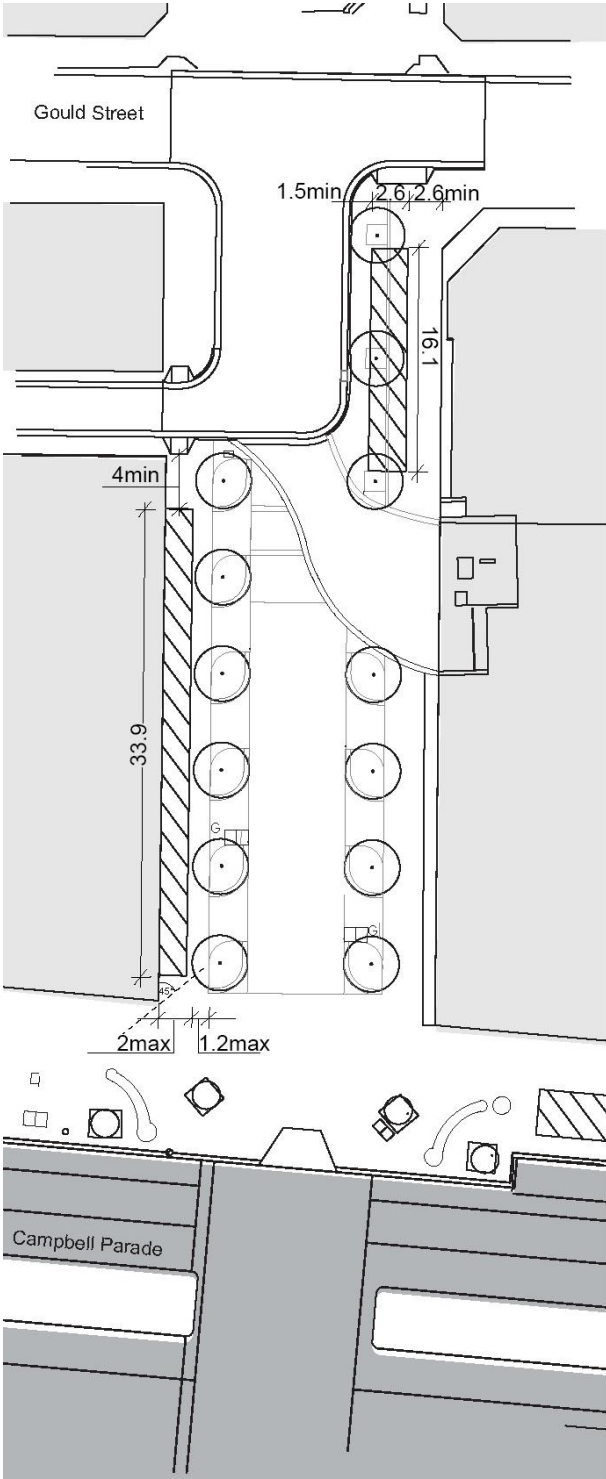
-  Designated Footpath Seating Area
-  Existing Public Seating
- G Garbage Bins
- P Public Telephone
- PM Parking Meter

- Notes**
- All dimensions in metres
  - Footpath seating must be:
    - minimum 2 metres from existing public seating
    - minimum 1.2 metres from parking metres
    - minimum 1.2 metres from garbage bins and public telephones






2.4.4 Roscoe Street Mall, Bondi Beach

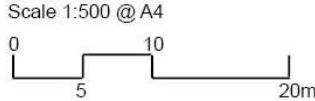
- (a) Roscoe Street Mall is to have a minimum clear pedestrian footpath of 1.2 metres from existing public seating at the Campbell Parade end and 2.5 metres at the Gould Street end as indicated on the designated footpath seating map in Map 7.
- (b) Footpath seating must be a minimum of 4 metres from kerb ramps, minimum of 1.2 metres from garbage bins.



Map 7. Roscoe Street Mall, Bondi Beach

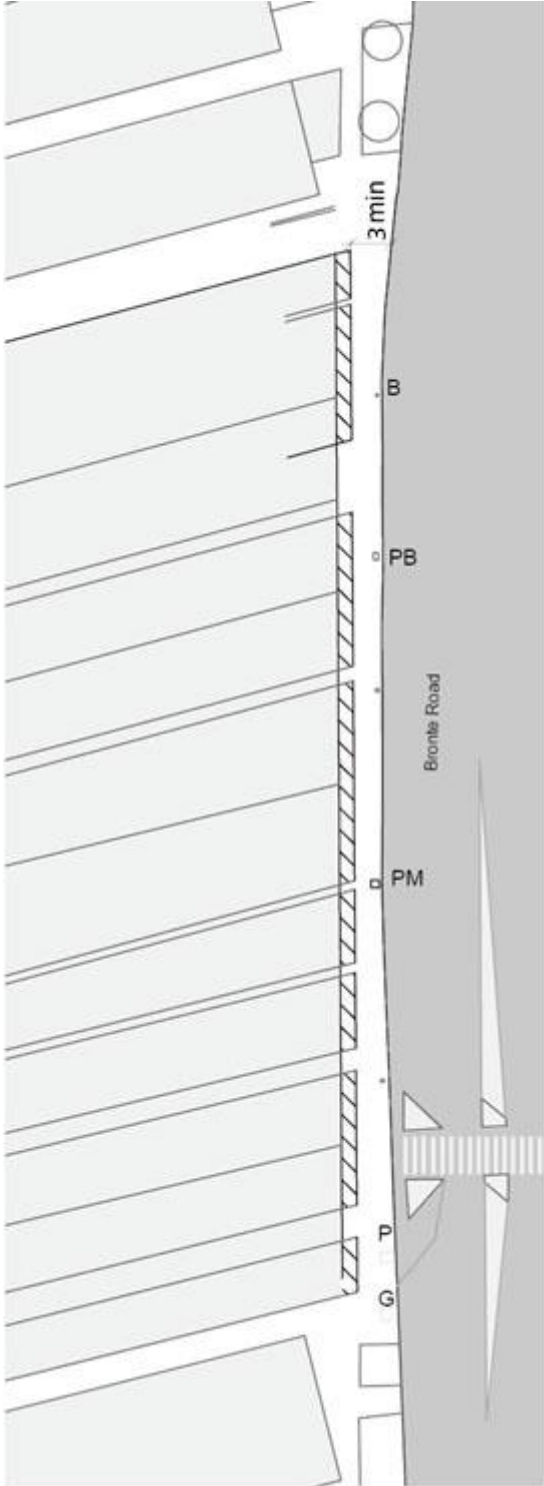
-  Designated Footpath Seating Area
-  Existing Public Seating
- G Garbage Bins
- P Public Telephone
-  Tree Canopy Approx.

- Notes
- All dimensions in metres
  - Footpath seating must be:
    - minimum 1.2 metres from existing public seating
    - minimum 1.2 metres from garbage bins
    - minimum 4 metres from kerb ramps



2.4.5 Bronte Road, Bronte Beach

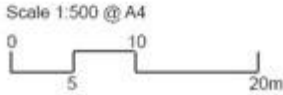
- (a) Bronte Road, Bronte Beach is to have minimum clear pedestrian footpath of 3 metres as indicated on the designated footpath seating map in Map 8.
- (b) Footpath seating in Bronte Road, Bronte Beach must be located against the shop front.
- (c) Footpath seating must be a minimum of 750mm either side of residential doorways.



**Map 8. Bronte Road, Bronte Beach**

-  Designated Footpath Seating Area
- P Public Telephone
- B Bus Stop (set down only)
- PB Post Box
- PM Parking Meter
- G Garbage Bins
-  Tree Canopy Approx.

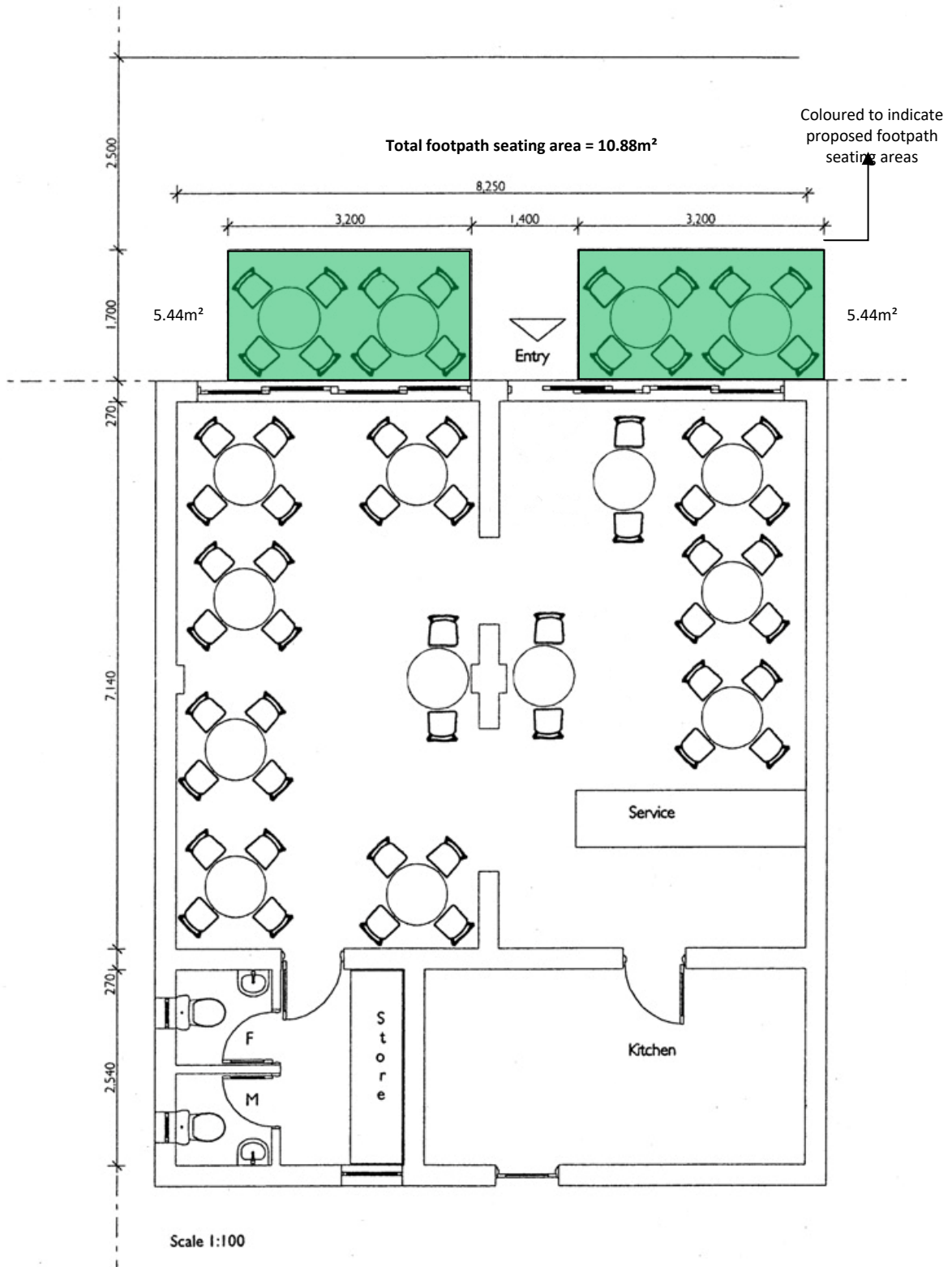
- Notes**
- All dimensions in metres
  - Footpath seating must be a minimum of 750mm from residential door ways



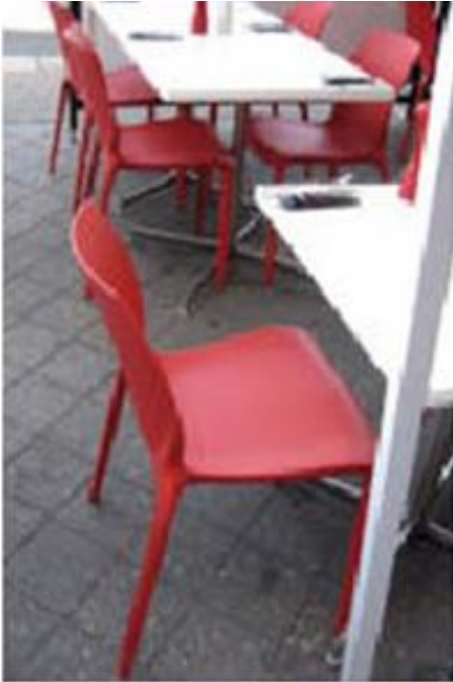


ANNEXURES

**Annexure D2-1**  
**Example of a Footpath Seating Application Plan**



Annexure D3-2  
Examples of furniture styles







## PART E SITE SPECIFIC DEVELOPMENT

*Part E Site Specific Development* is to be read in conjunction with *State Environmental Planning Policy (Housing) 2021 – Chapter 4 Design of residential apartment development*, the associated *Apartment Design Guide* and all relevant provisions of this DCP. Where there is an inconsistency between Part E and another Part, Part E prevails to the extent of the inconsistency.

<b>E1</b>	<b>BONDI JUNCTION .....</b>	<b>272</b>
1.1	Introduction .....	272
1.2	Urban Form Controls.....	273
1.3	Building Use.....	274
1.4	Access and Movement .....	276
1.5	Subdivision .....	279
1.6	Heritage and Buildings of Historic Character .....	281
1.7	Active Street Frontages.....	285
1.8	Building Orientation .....	286
1.9	Street Alignment .....	287
1.10	Separation Distances.....	291
1.11	Side and Rear Boundary Setbacks .....	294
1.12	Building Footprint.....	298
1.13	Number of Storeys .....	301
1.14	Views, Vistas and Tree Preservation .....	302
1.15	Open Spaces at the Street Frontage .....	303
1.16	Building Elevations .....	304
1.17	Designing Buildings for Flexibility.....	306
1.18	Ceiling Heights.....	307
1.19	External Living Areas .....	308
1.20	Wind Mitigation .....	309
1.21	Character Areas.....	311
1.22	Oxford Street Mall Provisions .....	316
<b>E2</b>	<b>BONDI BEACHFRONT AREA .....</b>	<b>326</b>
2.1	General Controls .....	327
2.2	Character Areas.....	332
<b>E3</b>	<b>LOCAL VILLAGE CENTRES.....</b>	<b>349</b>
3.1	Village Centre Specific Controls .....	351
3.2	Generic Controls.....	377
<b>E4</b>	<b>SPECIAL CHARACTER AREAS .....</b>	<b>384</b>
4.1	Bondi Heights.....	384
4.2	North Bondi.....	386
4.3	Ben Buckler.....	388
<b>E5</b>	<b>113 MACPHERSON STREET, BRONTE .....</b>	<b>390</b>
5.1	Public Domain .....	390
5.2	Built form.....	391
5.3	Active Street Frontages.....	393
5.4	Transport.....	394
<b>E6</b>	<b>194-214 Oxford Street, 2 Nelson Street and Osmund Lane, Bondi Junction .....</b>	<b>396</b>

6.1	Built Form .....	397
6.2	Design Excellence .....	398
6.3	Public Domain .....	399
6.4	Waste .....	401
6.5	Access and Parking .....	403
6.6	Pedestrian and Cycleway connections .....	404
<b>E7</b>	<b>EDINA ESTATE .....</b>	<b>405</b>
7.1	General .....	406
7.2	Site Layout .....	408
7.3	Built Form .....	410
7.4	Heritage .....	412
7.5	Public Domain and open space .....	415
7.6	Urban ecology .....	417
7.7	High-Performance Buildings and site resilience .....	419
7.8	Transport and site access .....	421
7.9	Waste .....	423
	<b>ANNEXURES .....</b>	<b>424</b>
	Annexure E1-1 Wind Tunnel Study .....	424
	Annexure E2-1 Design Guidelines .....	426
	ANNEXURE E3-1 TYPICAL BUILT FORM FOR TWO STOREY CENTRES .....	433
	ANNEXURE E3-2 TYPICAL BUILT FORM FOR THREE STOREY CENTRES .....	438
	ANNEXURE E3-3 TYPICAL BUILT FORM FOR FOUR STOREY CENTRES .....	443
	ANNEXURE E7-1 – CONSERVATION MANAGEMENT PLAN 2017 .....	448

E1 BOND JUNCTION

1.1 INTRODUCTION

This Part applies to land as identified in Figure 1. This Part must be read in conjunction with the *Public Domain Technical Manual – Bondi Junction Centre*, and the WDCP. Where there is an inconsistency between Part E and another Part of this DCP, Part E prevails to the extent of the inconsistency.

All development is to comply with *Part B11 Design Excellence*.



Figure 1 Bondi Junction Centre

## 1.2 URBAN FORM CONTROLS

### Objectives

- (a) To ensure that Bondi Junction Centre is a vibrant and attractive commercial area.
- (b) To define the desired future character and urban form for Bondi Junction Centre.
- (c) To reinforce the role of Bondi Junction as a Strategic Centre as identified by the NSW Government.
- (d) To promote built form that increases access to natural ventilation and lighting.
- (e) To coordinate building massing along streets and across blocks.
- (f) To ameliorate the effects of existing unevenly scaled and massed buildings.
- (g) To mitigate the visual effect of tall buildings on the street.
- (h) To mitigate environmental effects of tall buildings on existing surrounding low scale residential development.
- (i) To ensure the streetscape setting for heritage buildings and other noteworthy buildings is retained and enhanced.
- (j) To create diversity within the Bondi Junction Skyline.

### Controls

- (a) Development must be sensitive to the streetscape character and views. A streetscape and context analysis is to be provided in accordance with Part B11 Design Excellence.
- (b) A lower 2/3 storey shop front façade is required along Oxford Street and Bronte Road, as identified in Figure 12, and a 6 storey street wall is required on all other streets.
- (c) Above the block edge form a tower building form is required. This form is to be set back from the street edge and from the front, side and rear boundaries (refer to Figures 13 and 14).
- (d) Towers must be slender so as to:
  - (i) Facilitate cross ventilation;
  - (ii) Provide high quality amenity to occupants of the building;
  - (iii) Encourage view corridors;
  - (iv) Provide greater solar access to public spaces and other buildings; and
  - (v) Clearly differentiate between the podium and tower elements.

### 1.3 BUILDING USE

#### Objectives

- (a) To promote street level activity.
- (b) To reinforce the primary role of Bondi Junction as a Commercial Centre through high quality commercial development.
- (c) To retain lower levels of buildings for commercial and retail uses.
- (d) To increase the diversity and range of shopping and recreational opportunities for people who live, work and visit the Centre.
- (e) To enhance community safety by increasing activity in the public domain on week nights and on weekends.
- (f) To encourage a variety of uses.
- (g) To minimise conflicts between commercial and residential uses.

#### Controls

- (a) Comply with Figure 2 for Shopping Street Hierarchy locations.

#### *Primary shopping streets*

- (b) The Ground Floor of buildings along primary shopping streets must be designed and used for retail purposes.
- (c) The First Floor of buildings along primary shopping streets must be designed and used for commercial purposes but not limited to retail.

#### *Secondary shopping streets*

- (d) The Ground Floor of buildings located on secondary shopping streets must be designed and used for commercial purposes. Retail uses are preferred
- (e) The First Floor of buildings located on secondary shopping streets must be designed and used for commercial purposes.

#### *Laneways*

- (f) Retail and commercial frontages are encouraged along laneways where possible.
- (g) Laneway uses are not to interfere with services and vehicle access.

#### *Arcades, squares and through site links*

- (h) The Ground Floor must be designed and used for retail purposes.
- (i) The First Floor must be designed and used for commercial purposes.





Figure 2 Street Hierarchy

## 1.4 ACCESS AND MOVEMENT

### 1.4.1 Arcades, Through Site Links and Squares

#### Objectives

- To develop a comprehensive, compact, easy to follow, safe and accessible pedestrian network.
- To create pedestrian links through large developments to provide a fine grain pedestrian network.
- To ensure that private development does not diminish the public nature of streets and laneways at ground.
- To ensure that arcades are safe.
- To expand and enhance the public domain and promote pedestrian activity throughout the centre.
- To increase active street frontages and retail uses throughout the centre.

#### Controls

- Arcades, through site links and squares are to comply with the provisions of *Part B15 Public Domain*.
- Retain and provide arcades and through site links as shown in Figure 3.
- New arcades and through site links in addition to those shown in Figure 3 are encouraged.



Figure 3 Preferred through site links, arcades and squares



1.4.2 Vehicular and Service Access to Lots

Objectives

- (a) To locate and design vehicle and service entries to promote active frontages, pedestrian safety and undisturbed pedestrian movement.
- (b) To ensure that car parking is not visible from the street.
- (c) To ensure that the building facade and active frontages are the dominant streetscape element on all streets.
- (d) To limit the number of car park entry points to a development.
- (e) To minimise the size and quantity of vehicle and service crossings.

Controls

- (a) Comply with Figure 4 for locations for vehicular and service access.
- (b) Car park entries and exits must not occur along primary shopping streets.
- (c) All car park entries onto streets and laneways are to be enclosed by entry gates, roller doors or the like located in alignment with the street boundary.

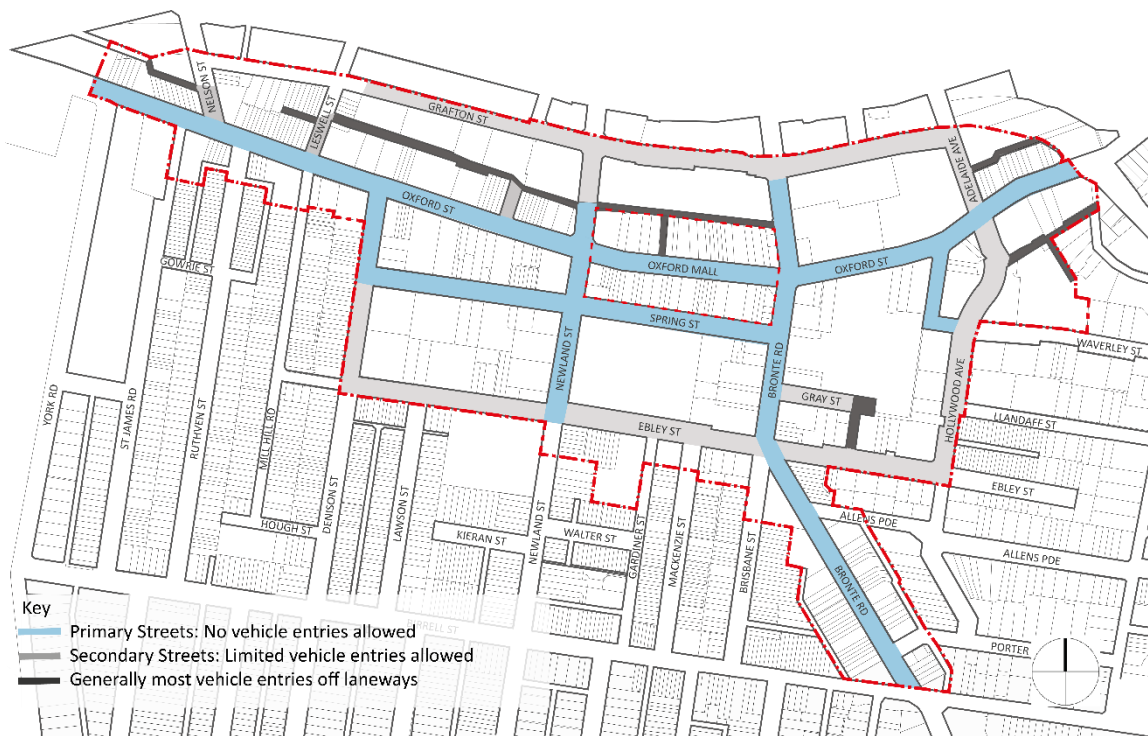


Figure 4 Vehicular and service access

---

**1.4.3 Pedestrian Overpasses and Underpasses****Objectives**

- (a) To protect and enliven streets by ensuring people circulate at street level.
- (b) To protect street level as the primary retail and commercial space of the centre.
- (c) To protect view corridors along streets.
- (d) To avoid overshadowing on streets.

**Controls**

- (a) Underpasses under public streets and laneways are not permitted unless linking directly into the public transport interchange.
- (b) Overpasses over public streets and laneways are not permitted.

---

**1.4.4 On-Site Parking****Objectives**

- (a) To avoid compromising street character, building quality, pedestrian amenity and safety through car parking.
- (b) To provide adequate space for parking and maneuvering of vehicles (including service vehicles and bicycles).
- (c) To recognise the complementary use and benefit of public transport and non-motorised modes of transport such as cycling and walking.

**Controls**

- (a) Car parks, car parking structures, vehicular maneuvering areas, private parking bays, loading docks and the like are generally to be located underground. Where this cannot be achieved due to topographic constraints, a maximum protrusion of 1.2m is permissible.

## 1.5 SUBDIVISION

### Objectives

- To reinforce the expression of small lot subdivision pattern in building form.
- To enrich the character and diversity within the centre.
- To define the public and private domains, maintain street hierarchy, and connection.
- To encourage a human scale in building design.
- To encourage a diversity of shop fronts along streets.
- To encourage the highest and best use of land along shopping streets.

### Controls

- Development is to comply with *Part B12 Subdivision*.
- Development is to retain the small lot subdivision pattern that reflects the original shop fronts along streets in the Bondi Junction Centre.
- Where this cannot occur due to amalgamation, the design of building elevations is to interpret the small lot subdivision pattern along the street front on lots (refer to Figure 5).
- The design of building elevations on lots is to generally use a 6m grid. This 6m grid can be varied by +/- 2m in order to match an existing grid of an existing building or lot.
- Comply with Figure 6 for small lot subdivision locations.

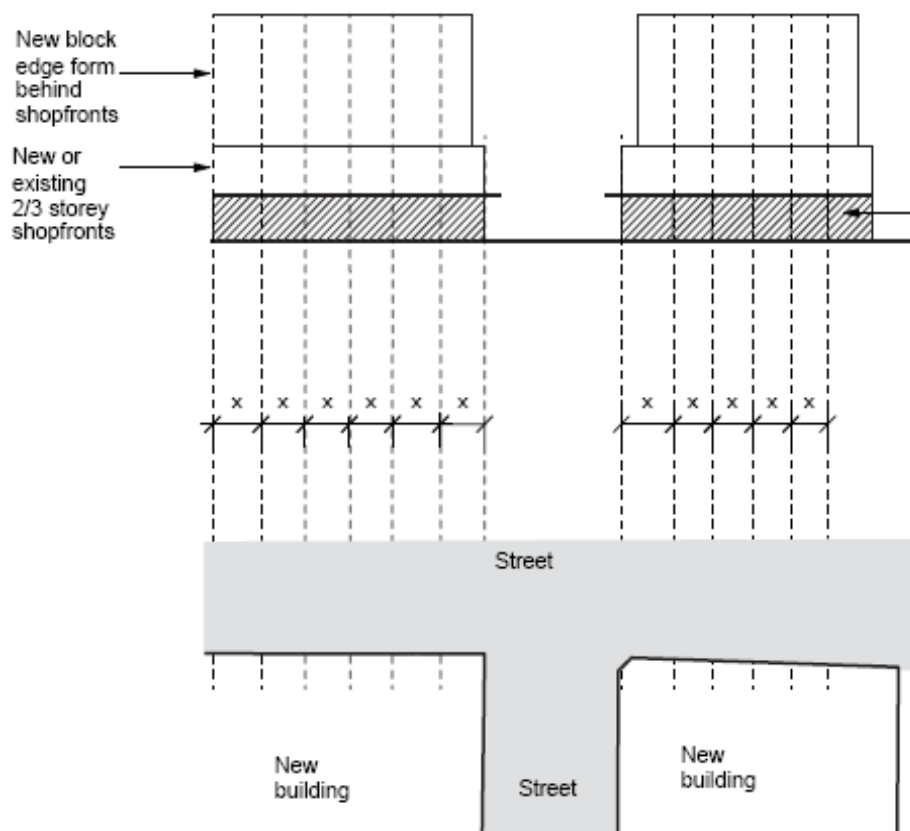


Figure 5 Interpretation of the patterns of small lot fronts



Figure 6 Building frontages to express the small lot subdivision pattern

## 1.6 HERITAGE AND BUILDINGS OF HISTORIC CHARACTER

### Objectives

- (a) To ensure buildings of historic character, and original shop fronts, are retained or reinterpreted.
- (b) To retain the streetscape setting of sites and buildings of historic, architectural and aesthetic significance.
- (c) To recognise the opportunities for heritage sites and contributory buildings to inform streetscape character.
- (d) To ensure developments in or adjacent to conservation areas retain and enhance the conservation values of that area.

### 1.6.1 Buildings of historic character

#### Controls

- (a) Lots identified with buildings of historic character are to retain as a minimum the facade (for a depth of 2m) of the building or preferably the whole building (refer to Figure 7).
- (b) Where a facade cannot be retained the new buildings are to interpret the scale, facade modelling including the location and percentage of glass to solid wall and the vertical and horizontal proportions of the existing building.
- (c) Where the building form, detailing or use of individual buildings of historic character have been inappropriately altered and changed, any application to upgrade or re-use the buildings must clearly demonstrate that the architectural and streetscape value of the building will be enhanced by the proposal.
- (d) Any application to demolish an identified building of historic character must clearly demonstrate that a replacement building will possess equal or higher quality contributory value regarding streetscape, character, architectural design and material quality.
- (e) New development adjacent to buildings of historic character must have facades sympathetic in vertical and horizontal proportions and alignments.
- (f) New buildings adjacent to buildings of historic character or heritage items should display proportions respectful of and build upon proportions similar to adjoining streetscape and forms.
- (g) New buildings adjacent to buildings of historic character or heritage items should draw on the predominant pattern of the streetscape. They are to be open & glazed at street level, have emphasis toward a singular enclosed building form at upper levels and be capped by a lighter more articulated element.



**Figure 7** Buildings of historic character

#### *Facades*

- (h) Original facade elements above awning level such as windows, parapets, balconies and ornamental detailing should be retained where possible.
- (i) Consistency should be achieved through; parapet height, string course both at parapet level, window proportions (sill and lintel height), awning height, fenestration and balcony elements, facade depth and modelling (refer to Figure 8).

#### *Height*

- (j) Match the streetscape proportions and scale of the heritage or contributory building facade.
- (k) The height of the building at the facade shall take into consideration existing parapets and other facade details of established surrounding development.
- (l) The height of awnings of heritage or contributory building should correspond to the surrounding area.

#### *Materials*

- (m) Ensure there is a positive integration of contemporary prefabricated building materials. Using materials similar to or compatible with the existing context (generally rendered or painted masonry).

#### *Windows*

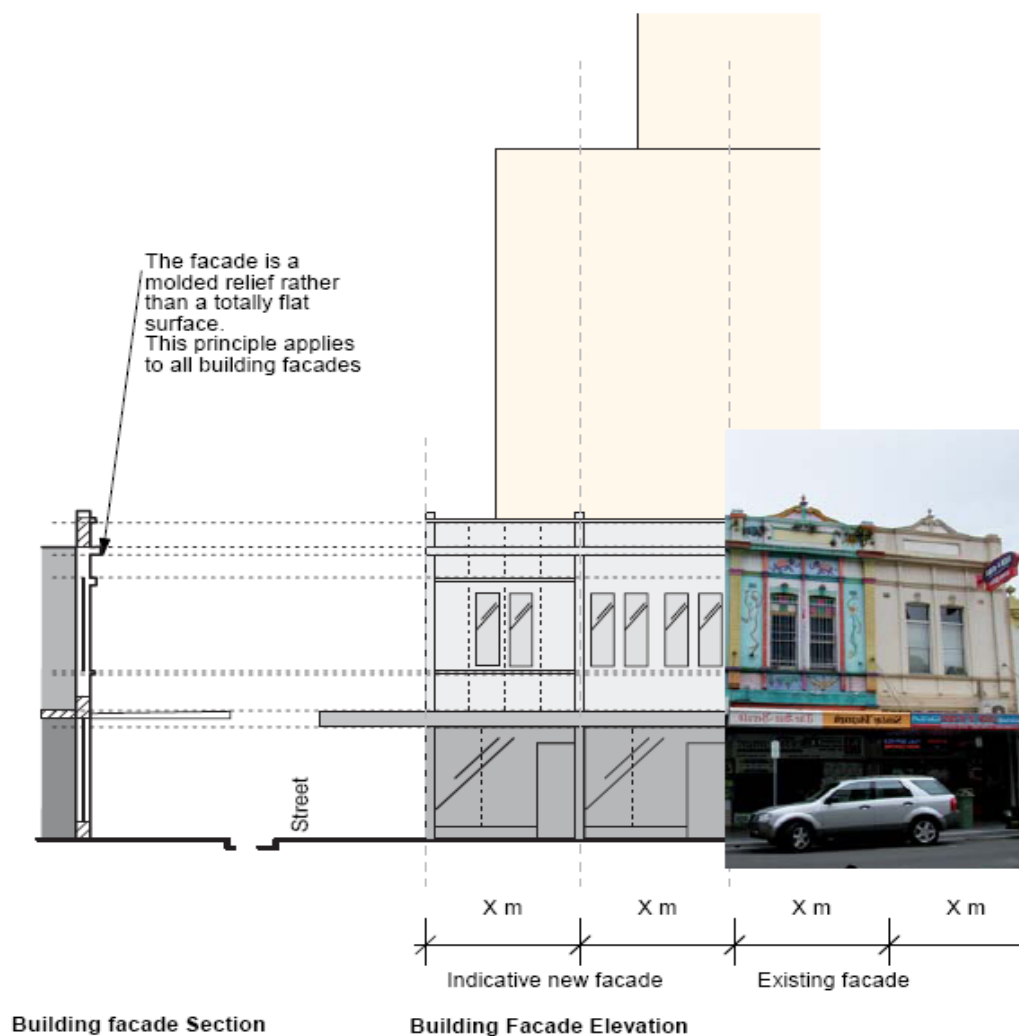
- (n) When restoring a facade that has been subject to substantial alterations over time, look to similar examples in the street to determine correct window proportion, style and materials.
- (o) Ensure the window area is proportionate to the wall mass.
- (p) Prefabricated aluminium windows will not be appropriate.

*Awnings*

- (q) Existing box section awnings, cantilever, or suspended by tie rods, should be retained. New awnings should match the form of adjacent awnings and maintain the same alignment.
- (r) Pitched or domed awnings of plastic, glass or canvas construction are not permitted.

*Colour*

- (s) Achieve a sympathetic juxtaposition of colour on adjacent building forms.
- (t) Ensure that a row of shops which are homogeneous or symmetrical in style adopt a uniform tonal distribution over the facade without limiting individual colour expression on each shop.



**Figure 8** Interpretation of buildings with historic character



## 1.6.2 Streets with Heritage and Buildings of Historic Character

### Objectives

- To ensure that the scale of existing height of original 2-3 storey shop fronts is retained along streets.
- To enhance the streetscape setting adjacent to heritage sites.
- To retain and reinforce a pedestrian scale to streets.
- To encourage ongoing adaptive re-use of buildings of historic character.

### Controls

- Buildings on lots with frontages identified in Figure 9 are to have a 2-3 storey façade along the street and are to be built to the street alignment.
- Balconies to the street facade are to be recessed behind the principle building facade.
- Open spaces and external building forecourts at street level are discouraged on streets with heritage buildings.



Figure 9 Street Frontage in streets with heritage



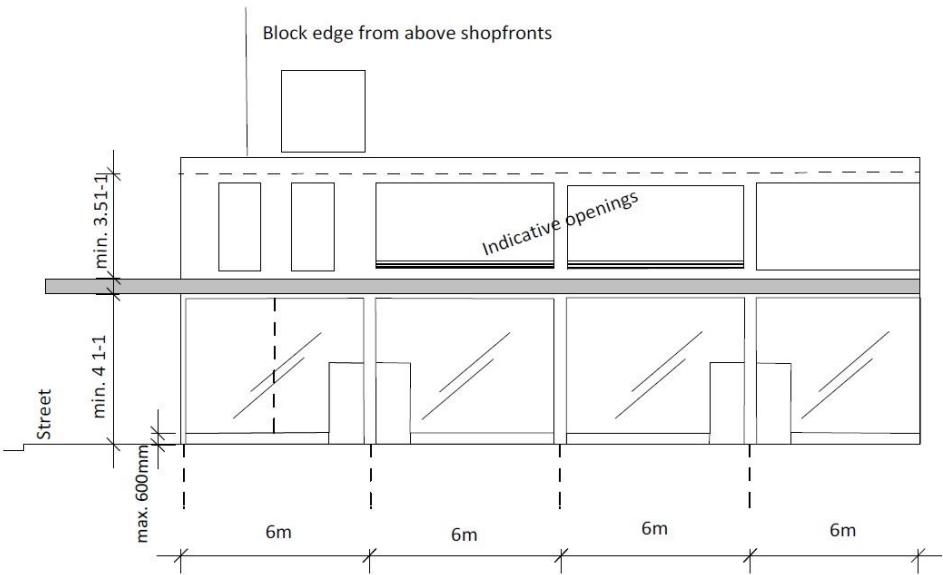
1.7 ACTIVE STREET FRONTAGES

Controls

- (a) Active Street Frontages are to be provided in accordance with Figure 10, Part B15 Public Domain and the WLEP Active Street Frontages Map.



Figure 10 Location of active frontages.



New shopfronts generally 6m +/- 2m wide, small lot subdivision pattern used to design proportions of new building elevations and shopfronts in streets with contributory buildings.

Figure 11 Primary shopping street active frontage

## 1.8 BUILDING ORIENTATION

### Objectives

- (a) To ensure that new development contributes to the streetscape in a positive way.
- (b) To provide passive surveillance for the street.
- (c) To easily achieve setback distances for privacy and outlook.
- (d) To provide a frontage and clear entry facing the street.
- (e) To avoid overlooking neighbouring dwellings.
- (f) To ensure the amenity of neighbouring buildings is provided.

### Controls

- (a) Podiums are to be oriented to and address the street(s).
- (b) Orient tower forms to the front and the rear of lots where possible. Avoid orienting primary windows to side boundaries.
- (c) Blank walls are not to front public streets.
- (d) Where possible orient bathroom, laundry and other ancillary room windows to the side boundaries.

#### **Calculation rules**

*Building orientation refers to the direction that the primary windows of living rooms and external living areas face.*

*Orientation to the front means that the primary windows of living rooms and external living areas face the street and are generally parallel to the front boundary.*

*Orientation to the rear means that the primary windows of living rooms and external living areas are generally parallel to the rear boundary.*

## 1.9 STREET ALIGNMENT

### Objectives

- (a) To reinforce the character of the commercial centre through consistent setbacks.
- (b) To enhance streets as the commercial and civic space for the centre.
- (c) To provide easy and legible pedestrian access ways and entrances into buildings.
- (d) To create consistent and unified building elevations along streets.
- (e) To improve the quality of the public domain.
- (f) To ensure building facades create a human scale to the street.
- (g) To define the space of public streets and other public spaces such as squares and parks.
- (h) To maximise safety within public places.

### Controls

#### *General Controls*

- (a) Buildings are to have front elevations aligned to the street boundary with setbacks in accordance with Figures 12-14.
- (b) A continuous street frontage is to be provided.
- (c) Situations where a variation to building in alignment with the street boundary may occur includes where the building is adjacent to a heritage building that may have a curtilage, setback or important building elevation facing the side boundary. In such cases a site specific heritage response is required, or the creation of a forecourt.
- (d) Open spaces at the street front for private buildings are not permitted.

#### *Podium*

- (e) Corner sites are to be built to both street alignments.
- (f) Development in streets with heritage, identified in Figure 12, are to include a 2/3 storey street wall, with a minimum 6m setback to built form above the street wall (refer to Figure 14).
- (g) Developments on all other lots are to have front building elevations built to the street alignment to 6 storeys (refer to Figures 12 and 13).

#### *Tower*

- (h) Towers are to be setback a minimum of 6m from the street wall and parallel to the street boundary (Figures 13 and 14).

#### **Calculation rules**

- The front setback is measured from the lot boundary along the street to the outer most edge of the building elevation (not the garage or car parking area).
- Setbacks are measured at 90 degrees from the lot boundary and include any articulation to the building elevation as well as including roofed or external living areas.



Figure 12 Street alignment.



Figure 13 Setbacks from the street: buildings in street without heritage

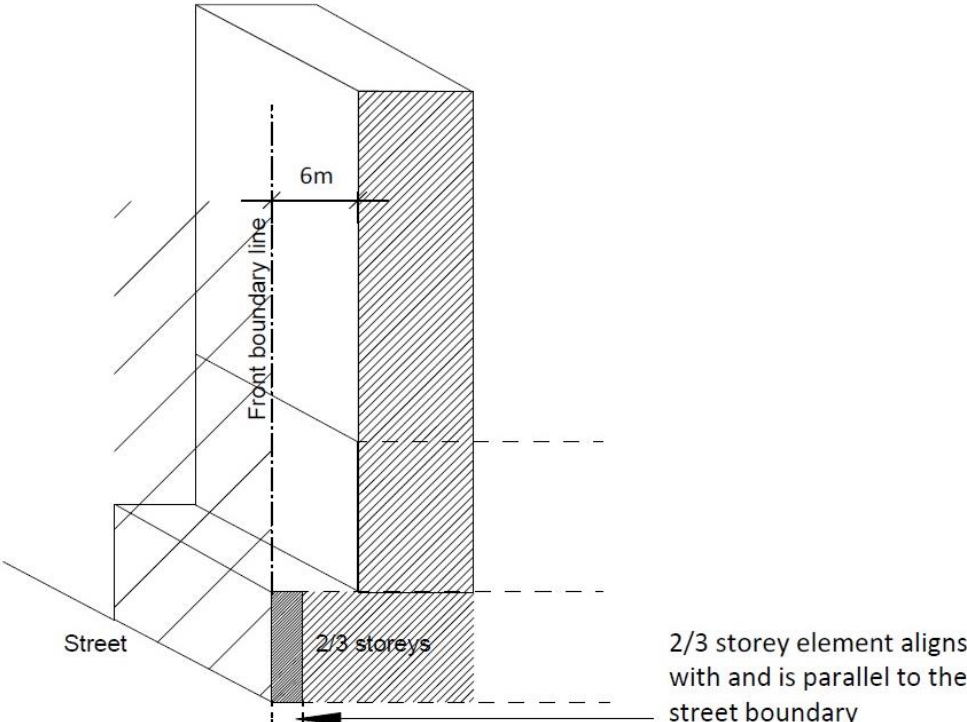


Figure 14 Setbacks from the street – buildings in streets with heritage

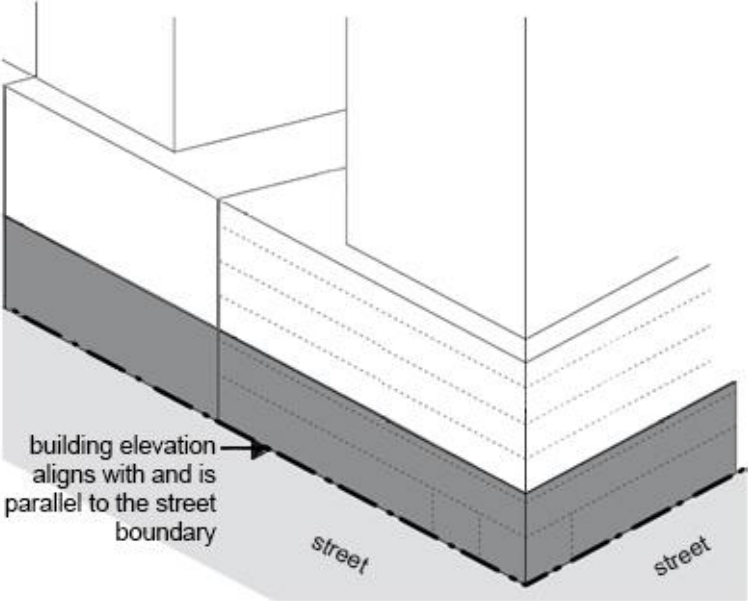


Figure 15a Corner sites build to boundary

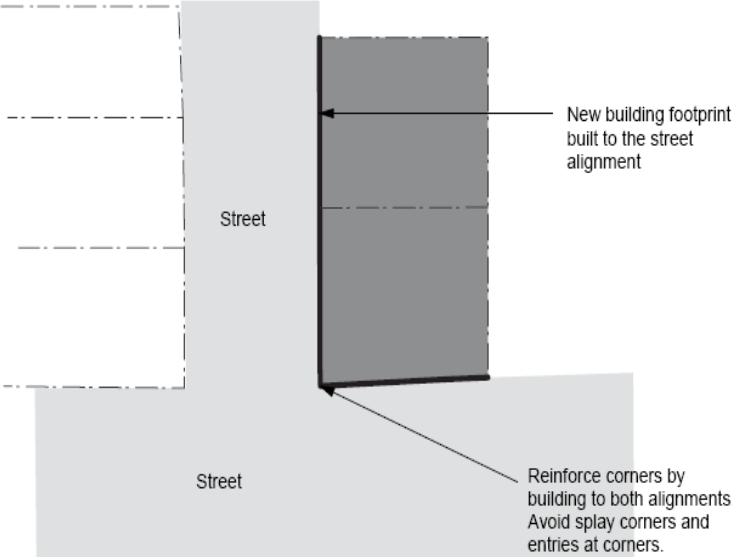


Figure 15b Corner sites build to boundary - Plan

## 1.10 SEPARATION DISTANCES

### Objectives

- (a) To provide amenity and liveability in new buildings.
- (b) To protect the amenity and liveability of existing buildings.
- (c) To facilitate visual and acoustic privacy between buildings.
- (d) To facilitate light and air to buildings.

### Controls

- (a) Development is to comply with the separation distances in Figures 16-18, and the *Apartment Design Guide* where applicable.
- (b) In podiums, windows must not be located or oriented to the side boundary for a distance of 8m from the front boundary to allow a continuous street wall to be provided.
- (c) Nil side setbacks can occur where separation distances permit, i.e. there are no windows or balconies within the relevant separation distance.

#### **Calculation Rules - Separation**

**Building orientation** refers to the direction of the external face of the building that provides the primary source of light, air and outlook to both residential uses (living room windows/doors and external living areas) and commercial uses (office or shop windows).

The measurement is to be taken from the windows/doors of the living room that give the rooms its primary source of outlook, light and air. Living areas include living rooms and external living areas such as balconies and terraces. For an external living area the measurement is taken from the outermost point of the balustrade.

**Primary windows:** For living rooms that have more than one orientation, the orientation that provides the primary source of light, air and outlook is to be used. These windows are described in the controls as primary windows.

**All other windows:** This includes bedroom windows and windows to non-habitable rooms. Living rooms that have a second orientation can also provide outlook, light and air to the room but in the case that greater privacy is required these windows/doors can be of opaque material, fixed, shaded or smaller in size.



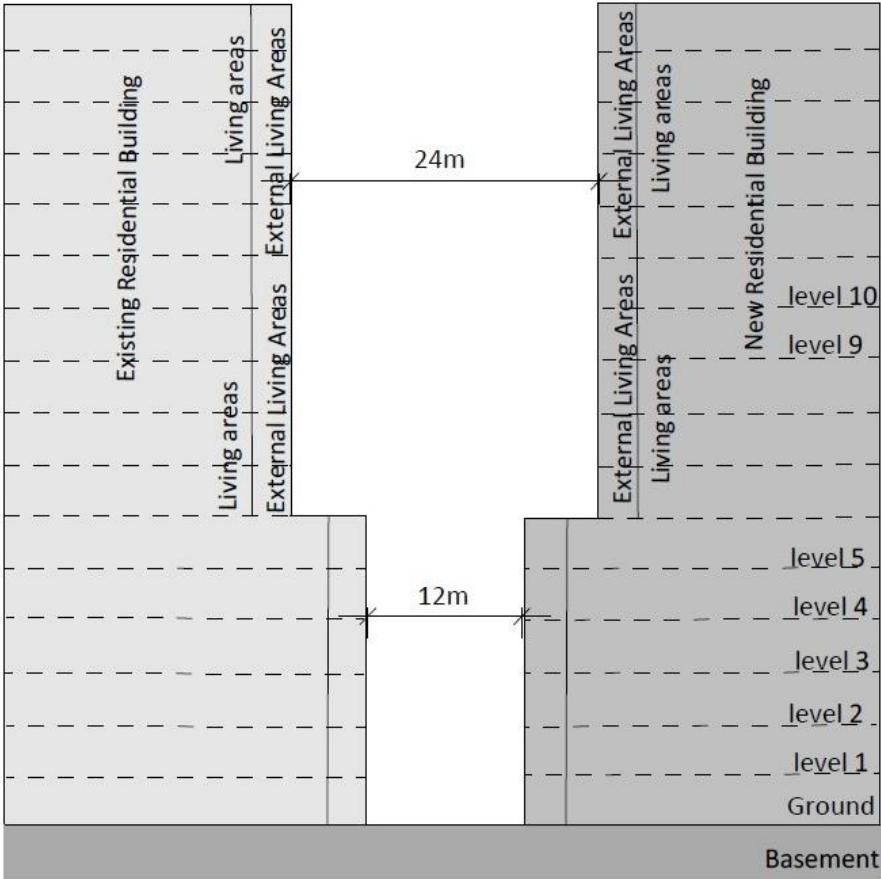


Figure 16 Minimum distances between residential living areas

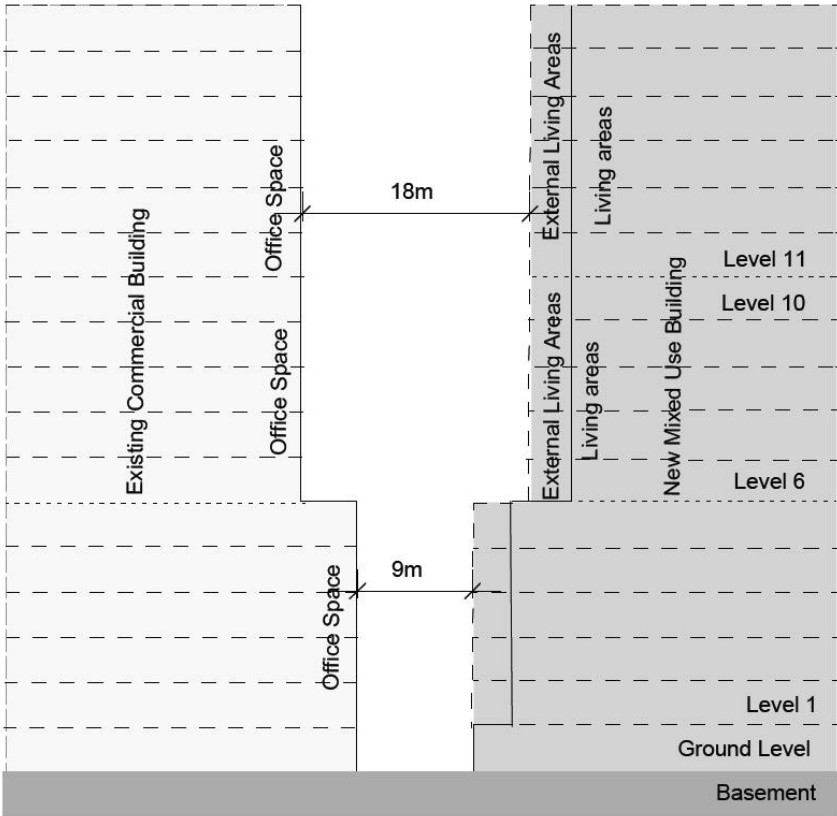


Figure 17 Separation distances between residential living areas and commercial uses



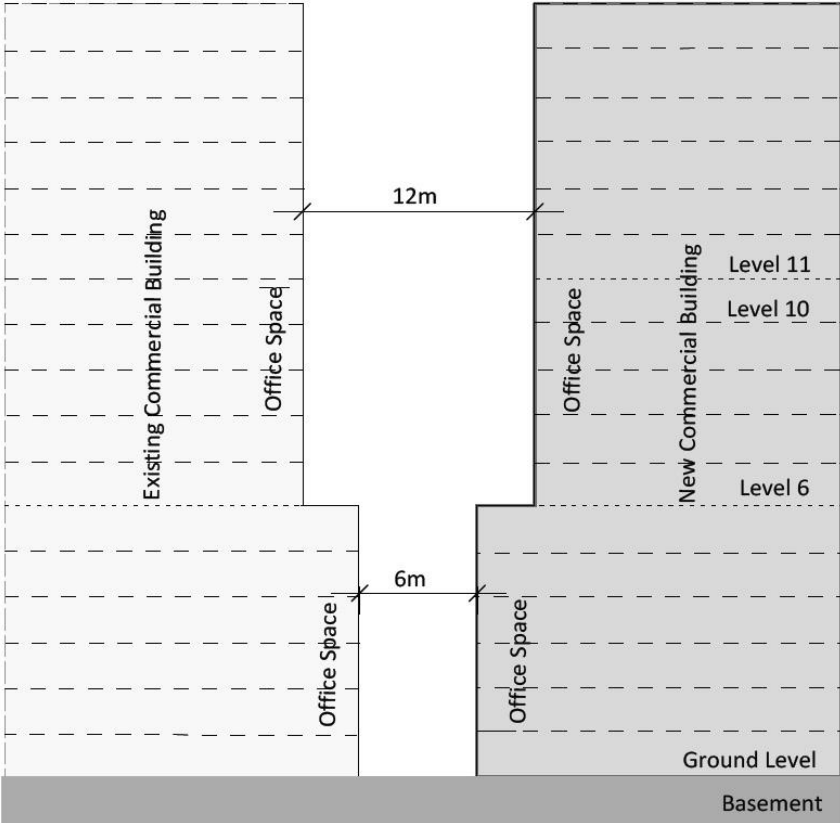


Figure 18 Separation distances between commercial uses

## 1.11 SIDE AND REAR BOUNDARY SETBACKS

### Objectives

- (a) To define the street space.
- (b) To facilitate visual and acoustic privacy between buildings.
- (c) To facilitate light and outlook.

### Controls

- (a) Refer to Figures 19, 20 and 21.

#### Podium

- (b) Where a blank wall exists on the adjacent property boundary wall, a nil setback is to be provided.
- (c) The podium nil side setback must be provided for a minimum of 8m measured from a front boundary (refer to Figure 19).
- (d) Where existing neighbouring buildings have windows or balconies at podium levels facing a side boundary, the following side setback distances apply:

<b>9m min.</b>	Primary windows of living areas/balconies
<b>4.5m min.</b>	All other windows
<b>3m min.</b>	All other windows on small sites (24m wide or smaller)

- (e) On lots with rear laneways, the rear boundary setback can be nil if adequate separation distances are met. The laneway is to be included in the separation distance (refer to Figure 21).

#### Tower

- (f) Where existing neighbouring buildings have windows or balconies at podium levels facing a side boundary, the following side setback distances apply:

<b>12m min.</b>	Primary windows of living areas/balconies
<b>6m min.</b>	All other windows

#### Calculation rules

- Side setbacks are measured from the lot's side boundary to the outermost edge of the building elevation i.e. edge of balustrades to balconies, rather than the glass line.
- Setbacks are measured at 90 degrees to the lot boundary and are measured to the outer most edge of the building elevation including balconies, terraces and porches.
- Rear boundaries may be either on a laneway or where two lots back onto one another.
- Lots that extend from street to street do not have rear boundaries but rather have two street frontages.

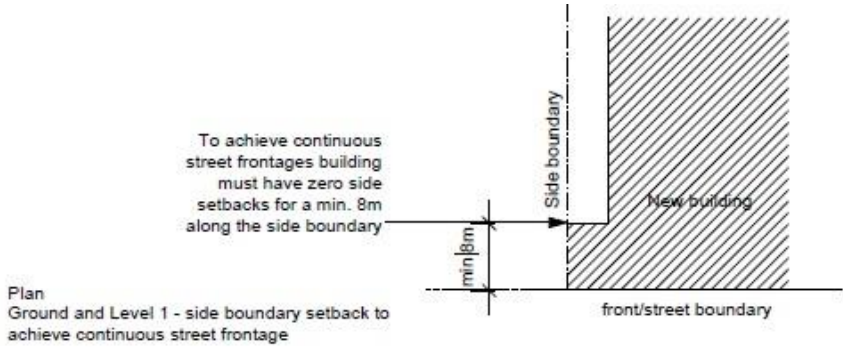


Figure 19a Side boundary setbacks – Ground and Level 1

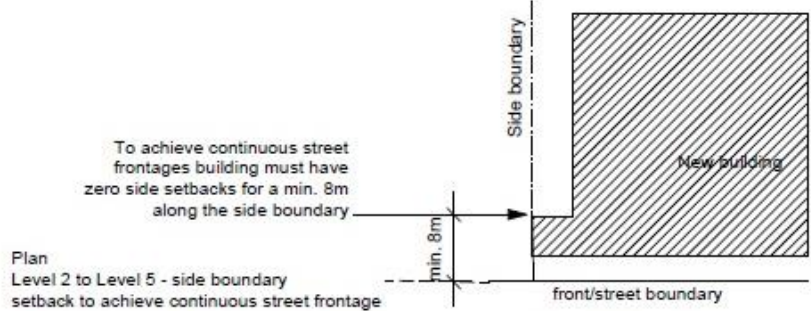


Figure 19b Side boundary setbacks – Level 2 to Level 5

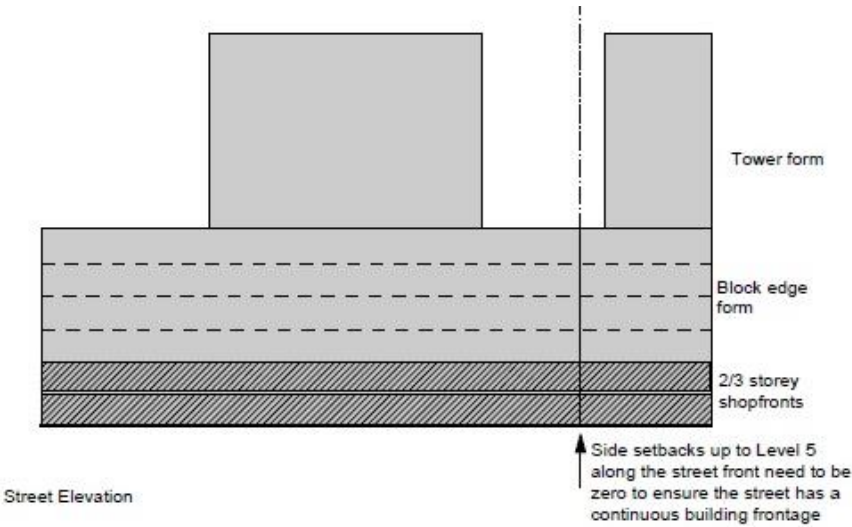


Figure 19c Side boundary setbacks - Elevation

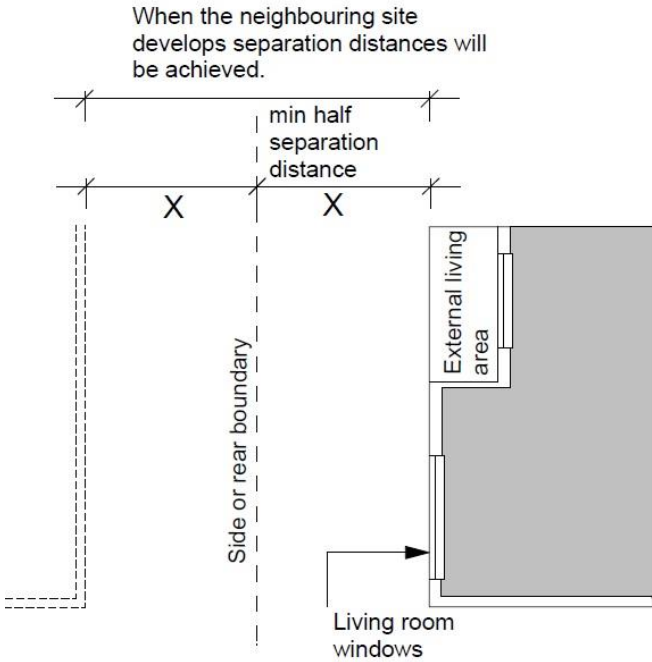


Figure 20a Plan - Side and rear boundary setbacks to prevent overlooking

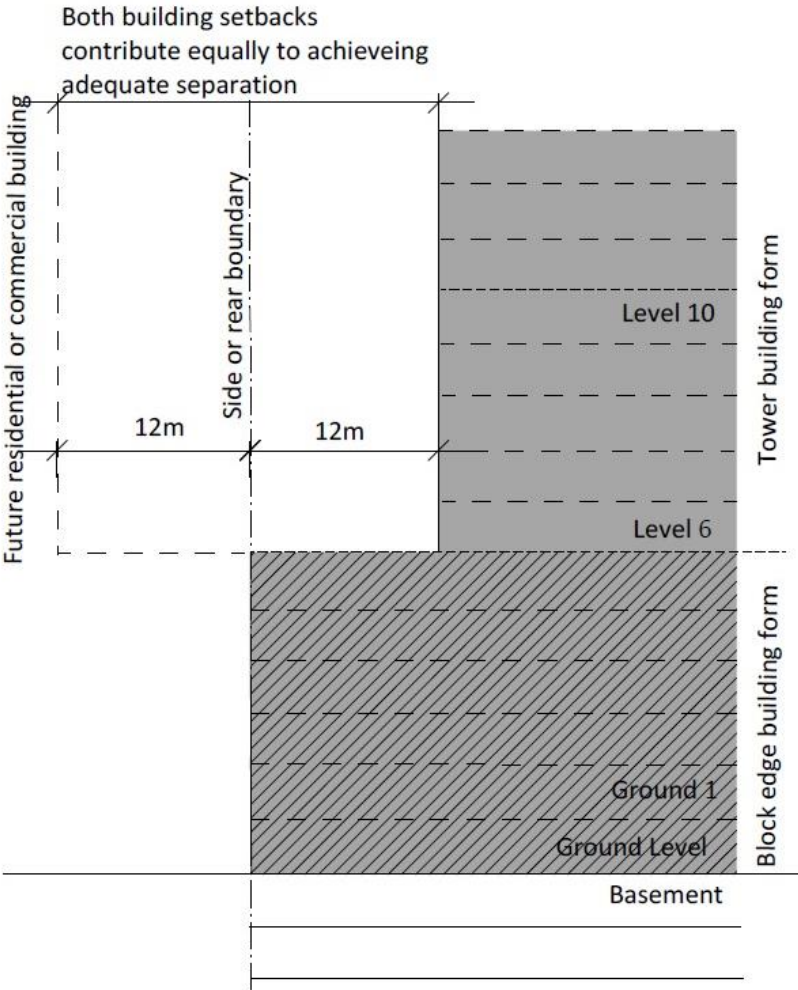
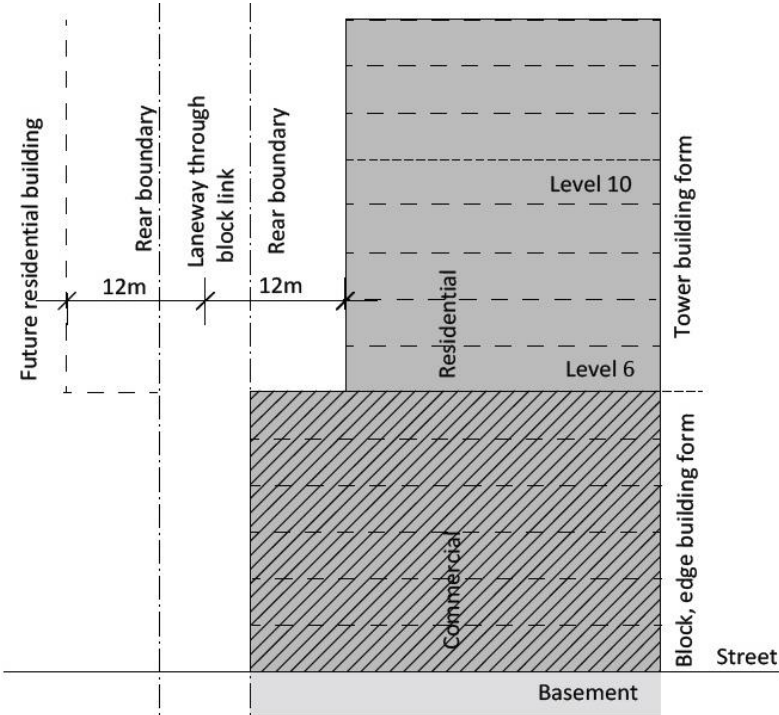
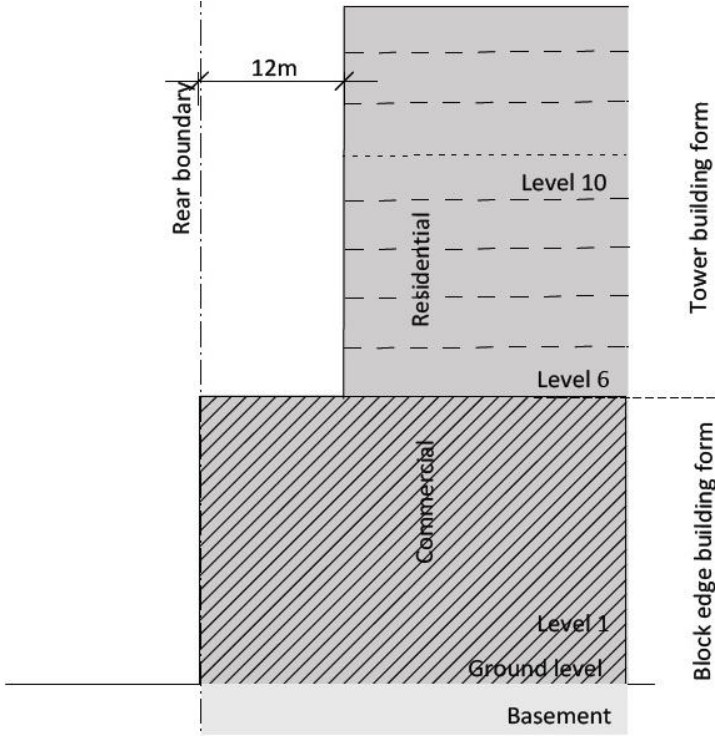


Figure 20 Elevation - Side and rear boundary setbacks to prevent overlooking



Section  
Rear boundary setback with a laneway

Figure 21a Section – Rear boundary setbacks with a laneway



Section  
Rear boundary setbacks

Figure 21b Section - Rear boundary setbacks

## 1.12 BUILDING FOOTPRINT

### Objectives

- (a) To reinforce the street edge.
- (b) To provide amenity in terms of solar access and natural ventilation.
- (c) To promote sustainable design that is less reliant on artificial heating, cooling and lighting by encouraging thin cross section buildings.
- (d) To provide ground and first floor plates which cater for commercial uses and to encourage commercial uses within the whole podium.
- (e) To provide for flexible commercial or residential uses in the tower components of buildings.
- (f) To ensure that shop fronts line commercial shopping streets.

### Controls

#### *General Controls*

- (a) To achieve narrow cross section buildings consider using atria, light wells and courtyards open to the sky to achieve additional daylight and or stack and cross ventilation.
- (b) The use of skylights to provide the primary source of daylight and ventilation to habitable rooms is not permitted.
- (c) Provide common areas such as corridors and entrances with natural light and cross ventilation i.e. openable windows.
- (d) Maximise daylight to all areas such as lobbies, corridors, kitchens and bathrooms by limiting the depth of buildings.
- (e) Avoid or minimise the reliance on mechanical ventilation or air conditioning to these areas.

#### *Podium*

- (f) Commercial:
  - (i) Commercial uses are to be provided in podium floors.
  - (ii) Podium floor plates may have a maximum 100% site coverage provided setback and separation controls are met (refer to Figure 22).

#### *Tower*

- (i) Commercial:
  - (i) Tower building forms are to be designed so that no habitable space is more than 15m from a source of daylight (refer to Figure 23).
- (j) Residential:
  - (i) Residential tower buildings are to comply with the *Apartment Design Guide*.

#### **Calculation rules**

**Building depth** refers to the dimension measured from the buildings front or street elevation to the rear elevation. Building depth includes the internal plan depth of the dwelling; it does not include external living areas.

**Building width** is measured from side building elevation to side building elevation. Building width is set by the width of the site minus the required side setback.



Mixed-use buildings may have a deeper ground level footprint to accommodate commercial uses with a narrower residential footprint above.

Some sites may have irregular site conditions such as topography or site shape. Such sites may require particular footprint design solutions that address such irregularities. For example buildings on narrow sites may require slender footprints to protect the amenity of neighbouring sites and to achieve the required setbacks. Sites on steep topography may require detached building footprints to account for the differences in grade.

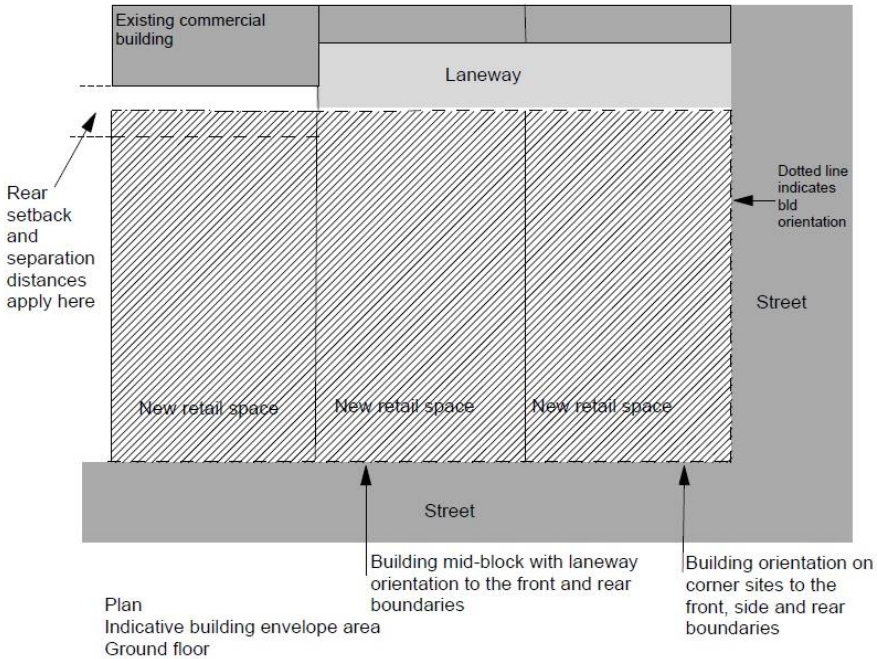


Figure 22a Indicative building footprints on a small site: Ground and Level 1

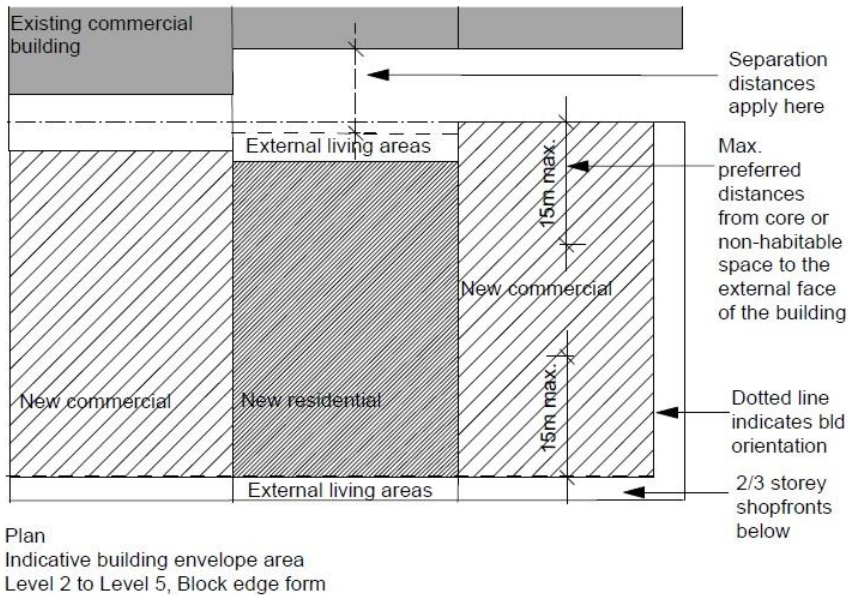


Figure 22 Indicative building footprints on a small site: Levels 2 - 5

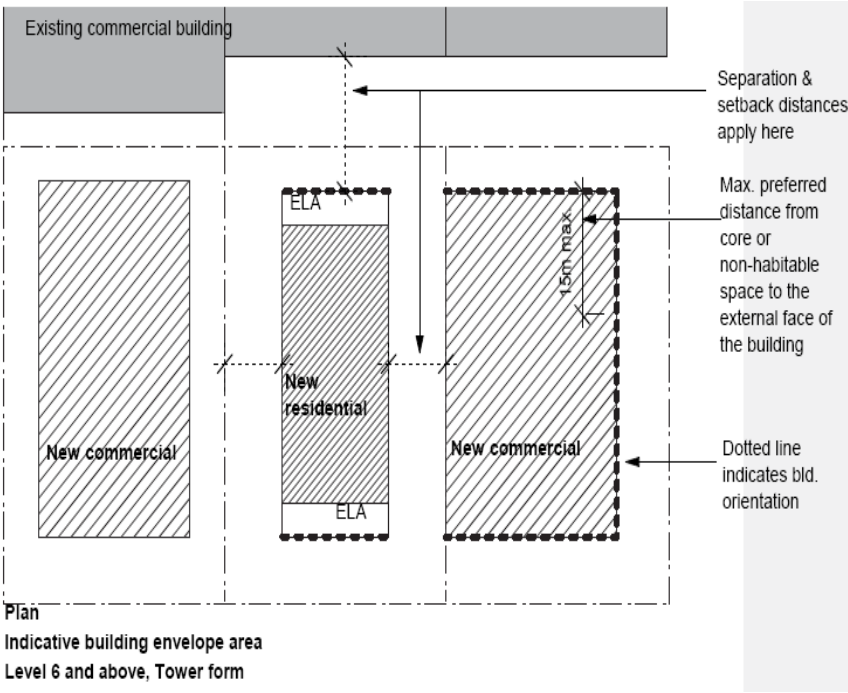


Figure 23 Indicative building footprint on a small site: tower building form

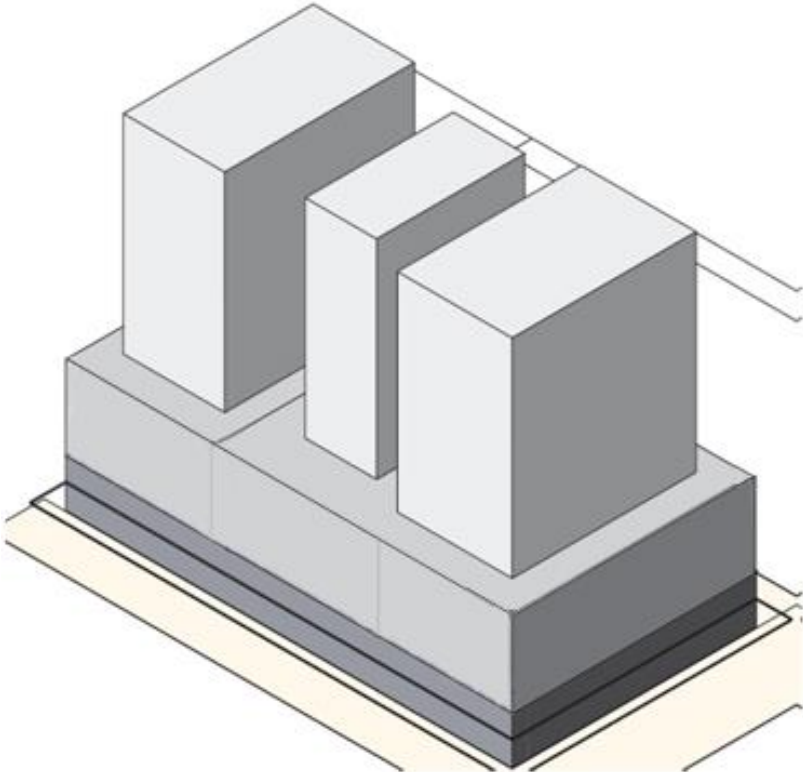


Figure 24 Indicative block 3D modelling of three footprint components



**1.13 NUMBER OF STOREYS**

**Objectives**

- (a) To ensure that internal amenity is not compromised to maximise development potential.
- (b) To ensure adequate internal amenity is provided through appropriate floor to ceiling heights.
- (c) To ensure buildings create a human scale to the street.
- (d) To encourage development and redevelopment potential.
- (e) To provide a transitional scale between commercial and residential.
- (f) To strengthen the urban form with consistent heights along streets.

**Controls**

- (a) Refer to the WLEP Maximum Height of Buildings map for absolute building heights.
- (b) Development may not achieve the maximum numeric heights due to topography or other site conditions.
- (c) Development must not exceed the maximum number of storeys for the site as specified on Figure 25.
- (d) Lots are to ensure they do not overshadow neighbouring or adjacent residential lots so as to preserve solar access to private open space.
- (e) Lots to the southern side of Ebley Street, and the southern side of Bronte Road are to drop to 2 storeys at the rear to achieve solar access for adjacent properties.



**Figure 25** Maximum number of storeys

**1.14 VIEWS, VISTAS AND TREE PRESERVATION**

Bondi Junction is located on a ridge which provides Bondi Junction with vistas of the Woollahra ridge slopes and Harbour Foreshore glimpses to the north down Newland Street and Bronte Road. To the south, there are vistas of the suburbs of Queens Park, Randwick and Clovelly.

The most important views within Bondi Junction occur along its streets. These views along streets frame the overall visual quality of the centre and help to define and differentiate different places within the centre. As such they are intrinsic to the quality of the urban environment and are to be retained and enhanced in the future.

**Objectives**

- (a) To retain significant vistas.
- (b) To recognise the importance of Bondi Junction Centre or street views.
- (c) To enhance views and vistas throughout the centre.
- (d) To retain significant trees and vegetation.

**Controls**

- (a) Retain vistas along Newland Street, Bronte Road and Grosvenor Street both to the south and the north.
- (b) No building or structure is to build into or on a street view corridor.
- (c) Development proposals that open up significant vistas from the public domain are encouraged, particularly north-south vistas.
- (d) Comply with Figure 26 for locations of views and vistas referred within this section.



**Figure 26 Views and vistas**

**1.15 OPEN SPACES AT THE STREET FRONTAGE****Objectives**

- (a) To ensure private buildings are built to the street alignment.
- (b) To retain a consistent alignment along streets.
- (c) To retain and increase activity on the street front.
- (d) To increase safety of the public domain and passive surveillance.
- (e) To encourage public buildings to create forecourts that are well designed and enhance the public domain.

**Controls**

- (a) New open spaces on the street front for private buildings are not suitable for Bondi Junction.
- (b) New open spaces on the street front for public buildings may be considered if they meet the following controls:
  - (i) New open spaces require active frontages along all the built sides of the space.
  - (ii) Logical and functional pedestrian connections through and beyond the space are to be provided.
  - (iii) Clear sight lines into and throughout the space.
  - (iv) The space must be accessible and useable to the public.
  - (v) Public open spaces must not be located on block and street corners, and must be a min. of 10m from a corner.

## 1.16 BUILDING ELEVATIONS

### Objectives

- (a) To establish a building's identity in the streetscape and contribute to the centre as a whole.
- (b) To ensure elevations reflect the use of the building, and address environmental conditions.
- (c) To promote high architectural quality in buildings.
- (d) To create buildings which respond to environmental conditions.
- (e) To reduce reliance on mechanical heating and cooling.
- (f) To improve visual quality of communal spaces and public places.

### Controls

- (a) All elevations must be architecturally designed and contribute to the character of the street in which they are located.
- (b) Design building elevations which incorporate the principles of passive design and the properties of thermal mass, glazing and insulation, to reduce the need to artificially heat or cool.
- (c) Provide openable windows to living and working environments.
- (d) Facades are not to be totally flat but rather to have relief modelling.
- (e) Refer to Figures 27 and 28 for indicative elevations and facades.

#### *First Floor elevation*

- (f) Elevations are to be composed of a solid wall with punched openings. The solid wall is to have relief modelling.
- (g) The horizontal proportions of the facade must relate to the ground level shop fronts.
- (h) Facades can have an openness ratio of up to 35% of one bay of a facade, the remaining 65% must be solid.

#### *Second to fifth floor elevation*

- (i) Elevations are to be composed of a solid wall with punched openings.
- (j) The horizontal proportions of the facade must relate to the ground level shop fronts.
- (k) Building facades can have an openness ratio of up to 45% of one bay of a facade, the remaining 55% must be solid.
- (l) Balconies must be recessed from the main elevation.
- (m) The tower component of buildings can be highly individual in character.

#### *Above fifth floor elevation*

- (n) The maximum unarticulated wall length is 25m<sup>2</sup>.
- (o) Use solar protection elements appropriate to north facing facades such as awnings, deep reveals, roof overhangs.
- (p) Use solar protection elements appropriate to east or west facing facades such as external louvers, shutters, screens. These may be used in conjunction with awnings, deep reveals, roof overhangs.

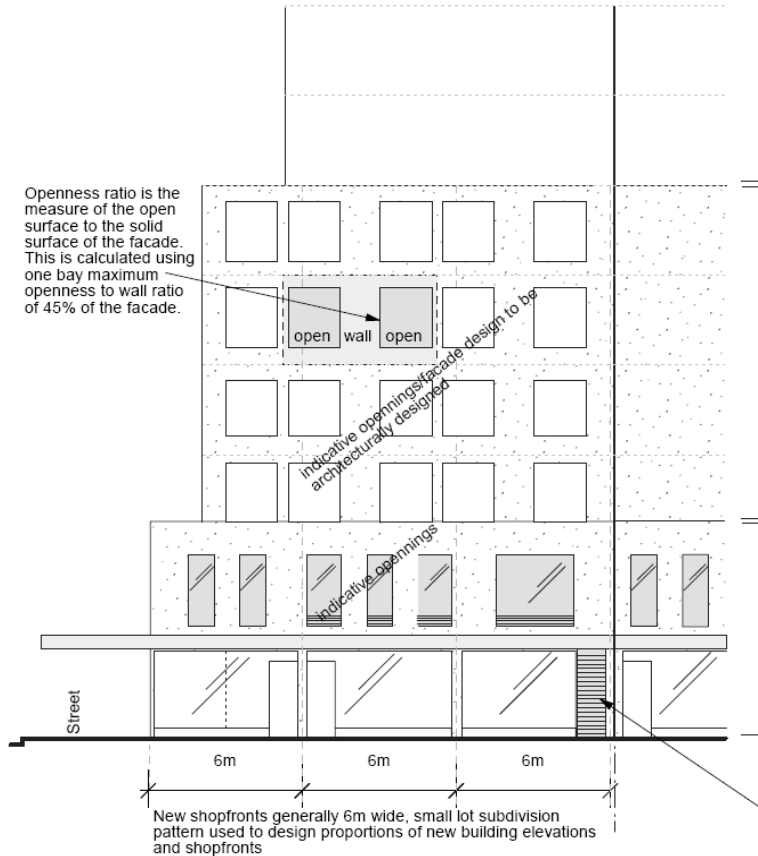


Figure 27 Elevations

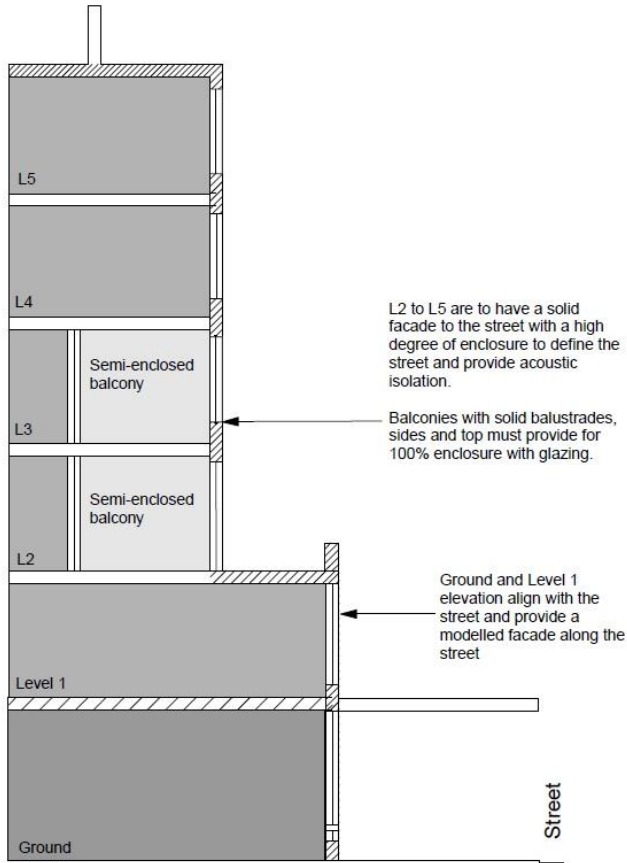


Figure 28 Façade section

**1.17 DESIGNING BUILDINGS FOR FLEXIBILITY****Objectives**

- (a) To improve the quality of the built environment and apply sustainable practices.
- (b) To encourage the design of low energy consumption, durable, flexible, adaptable buildings.
- (c) To promote the design of robust buildings to allow flexibility over time, for conversion between residential and commercial uses.

**Controls**

- (a) Design the podium component of buildings (Level 2 – Level 5) to permit adaptation for other future uses, with minimal structural and service alteration by:
  - (i) Concentrating the location of service elements such as fire stairs, air conditioning units, service risers, toilets, kitchens and the like together to allow larger free floor plate areas; and
  - (ii) Designing service areas and risers generously to make them readily accessible and capable of additional capacity.

## 1.18 CEILING HEIGHTS

### Objectives

- (a) To ensure internal amenity is maximized.
- (b) To promote solar access into all buildings.
- (c) To ensure adequate spatial provision for services.

### Controls

- (a) Coordinate internal ceiling heights and slab levels with external height datum lines such as datum and parapet lines set by surrounding existing buildings.
- (b) Increase the sense of space in rooms through provision of well-proportioned rooms.
- (c) Use tall windows or highlight windows, as well as light shelves and fan lights to reflect natural light deeper into a floorplate.
- (d) Stack wet areas from floor to floor to allow taller floor to ceiling heights in habitable areas.
- (e) Commercial and retail buildings must provide the following ceiling heights:
  - (i) Minimum 4m floor to ceiling heights at Ground Floor
  - (ii) Minimum 3.3m floor to ceiling heights at First Floor and above.

## 1.19 EXTERNAL LIVING AREAS

### Objectives

- (a) To provide an external living area for each dwelling.
- (b) To enhance the amenity of internal living spaces.
- (c) To ensure that external living areas do not adversely impact on the amenity of nearby properties.

### Controls

- (a) External living area is to be screened to achieve visual privacy if located less than 4m from a side boundary.
- (b) The rooftops of developments can be used to provide external living areas.
- (c) Detail and design balconies or terraces in response to the local climate and context, thereby increasing their usefulness. This may be achieved by:
  - (i) Locating balconies and terraces facing predominantly north or east, utilising sun screens, shutters and operable walls to control light and wind;
  - (ii) Providing balconies or terraces with operable screens, Juliet balconies or operable walls/sliding doors with a balustrade may be preferable in special locations where noise or high winds prohibit other solutions;
  - (iii) On towers, use cantilever balconies, partially cantilever balconies and/or recessed balconies in response to daylight, wind, acoustic & visual privacy;
  - (iv) Design balustrades to allow views and casual surveillance of the street while providing for safety and visual privacy; and
  - (v) Detail balustrades using a proportion of solid to transparent materials to address site lines from the street, public domain or adjacent development.



## 1.20 WIND MITIGATION

### Objectives

- (a) To mitigate the effects of strong wind at street level.
- (b) To ensure wind does not preclude the functioning of the centre's key uses.
- (c) To encourage development to utilise the predominant breeze direction to inform an energy efficient design.

### Controls

- (a) Buildings shall not create uncomfortable or unsafe wind conditions in the public domain that exceed the Acceptable Criteria for Environmental Wind Conditions.
- (b) Locate or design outdoor areas to ensure places with high wind level are avoided.
- (c) All applications for buildings over 5 storeys in height shall be accompanied with a wind environment statement, unless a wind tunnel study is required. For buildings over 9 storeys and for any other building which may be considered an exposed building, applications shall be accompanied by a wind tunnel study report (refer to *Annexure E1-1*).
- (d) Acceptable Criteria for Environmental Wind Conditions:

Area Classification	Limiting Weekly Maximum Gust-Equivalent Mean	Limiting Annual Maximum Gust
Outdoor dining areas, amphitheatres etc	3.5m/s	10 to 13m/s
Main retail centres such as Oxford St Mall, parks, communal recreational areas such as common swimming pool on the podium	5.5m/s	13m/s
Footpaths and other pedestrian access ways	7.5m/s	16m/s
Infrequently used laneways, easements, private balconies	10m/s	23m/s

**Note:** Gust-Equivalent Mean is defined as the maximum 3 second gust divided by a local Gust Factor for the local wind speed. It is recommended that the local gust factor be derived from the measured local turbulence intensity. If the mean wind speed happens to be greater than the Gust-Equivalent Mean then the Mean wind speed is to be adopted in place of the Gust-Equivalent Mean.

The Annual Maximum Gust wind speed criteria can be used as an alternative to the Gust-Equivalent Mean Criteria. If the Gust-Equivalent Mean criteria are being used then a check should also be made to ensure that all areas studied are within the Annual Maximum Gust wind speed of 23m/s.

When assessing the impact of a proposed development, no increase over the existing wind conditions is acceptable unless the increase over the existing conditions is such that the relevant criterion for that type of space is still satisfied.

**Calculation rules**

*Natural wind conditions are intensified by certain types of buildings by the way they relate to the surrounding area. In this section, those buildings are called exposed buildings.*

*A building may be considered exposed if half or more of its height rises above surrounding buildings and/or the building lies on the perimeter of a built up area.*

*Exposed buildings are likely to create unpleasant and even dangerous high winds, mainly in three locations: at the base, around corners or through arcades or other openings at the base of the building.*

*In addition the areas within the exposed buildings that could potentially experience adverse wind effects are the areas on the podium, terraces on the roof or on setbacks in the tower as well as projecting or corner balconies.*

## 1.21 CHARACTER AREAS

Bondi Junction contains a number of areas that contain similar characteristics and development potential, and are known as Character Areas as shown in Figure 29.

These include:

- A – West Oxford Street
- B – Oxford Street Mall
- C – Ebley Street Transition Corridor
- D – Bronte Road Village Centre

The additional provisions provided in Part E1 apply to these Areas.

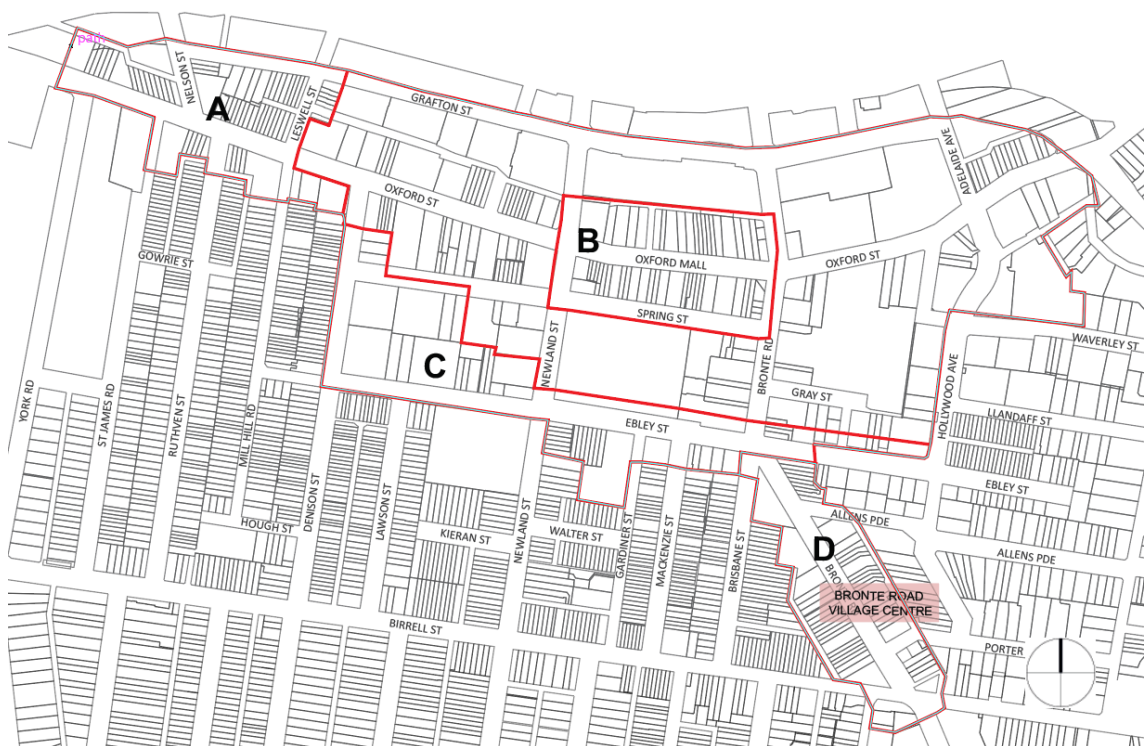


Figure 29 Neighbourhood Areas

### Objectives

- (a) To ensure that development is consistent with the desired future character of the Bondi Junction centre.

### Controls

- (a) Development within the Bondi Junction centre must be consistent with the desired future character objectives for that area.

### 1.21.1 West Oxford Street



Figure 30 West Oxford Street Area

#### Existing Character and Built Form

West Oxford Street has a “village”-feel character with low-density built-form. The majority of existing development contains ground floor awnings and minimal front setbacks. Little development exceeds two storeys in scale.

The Area contains a mix of both large and small lots, providing opportunity for a mix of retail and commercial formats.

#### Desired Future Character Objectives

- (a) To protect the residential amenity of surrounding residential sites.
- (b) To retain established low-density character and “village” feel.

1.21.2 Oxford Street Mall

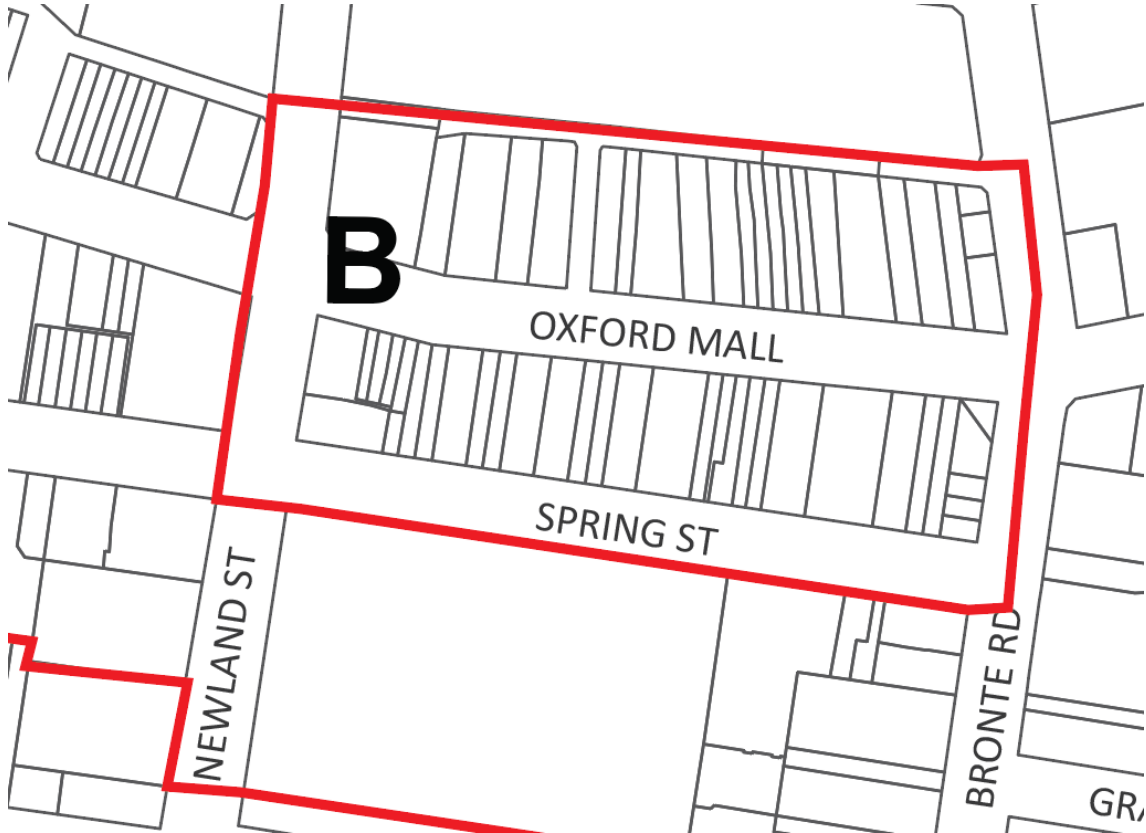


Figure 31 Oxford Street Mall Area

Refer to Part E1.22 of this DCP.

### 1.21.3 Ebley Street Transition Corridor

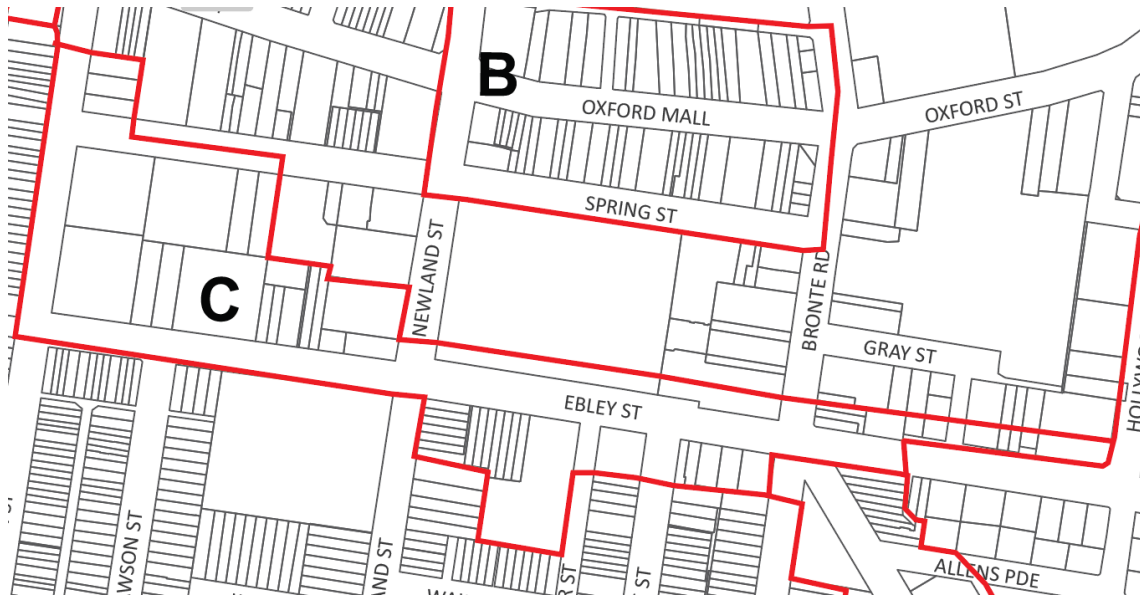


Figure 32 Ebley Street Transition Corridor Area

#### Existing Character and Built Form

Larger format non-residential land uses, including civic buildings and retail are provided within this area, facilitated by the larger lot sizes.

#### Desired Future Character Objectives

- (a) To facilitate larger format non-residential land uses.
- (b) To provide for a visual transition between the higher density development to its north, and the lower density development to its south.

1.21.4 Bronte Road Village Centre

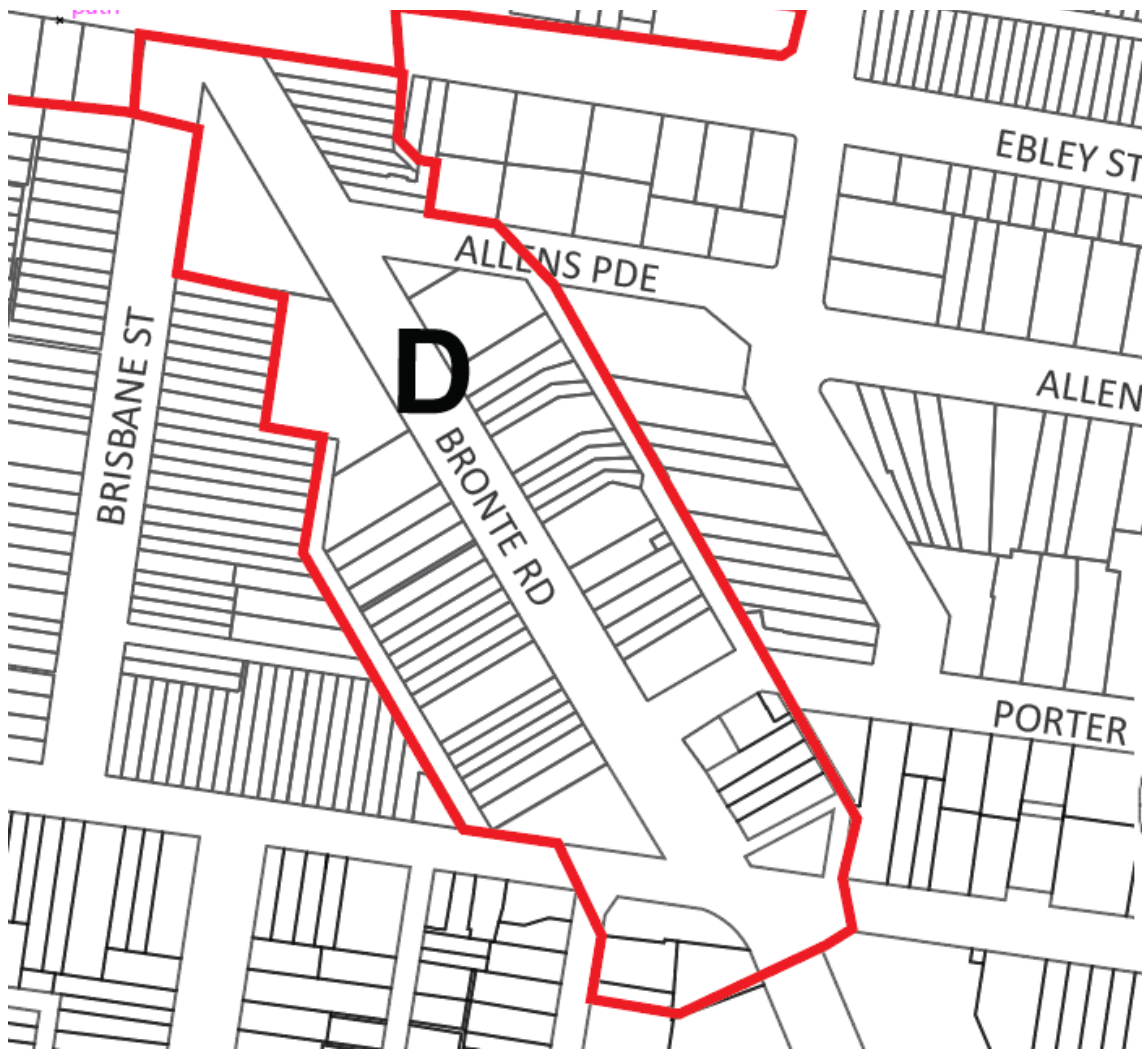


Figure 33 Bronte Road Village Centre Area

Refer to Part E3.1.1 of this DCP.

## 1.22 OXFORD STREET MALL PROVISIONS

### 1.22.1 Building to street alignment and street setbacks

#### Objectives

- (a) To provide street edges that reinforce, improve or support the hierarchy and character of specific streets.
- (b) To establish desirable spatial proportions within the street and definition of street edge.
- (c) To create a clear transition between public and private space.
- (d) To locate active uses, such as shop fronts, closer to pedestrian activity areas.
- (e) To assist in achieving visual privacy to apartments from the street.
- (f) To create good quality entry spaces to lobbies, foyers or individual dwelling entrances.
- (g) To allow an outlook to, and surveillance of, the street.
- (h) To maintain sun access to the public domain.

#### Controls

- (a) Buildings in Oxford Street Mall are to be built to the street alignment as set out in Figure 34.
- (b) Minor projections into front building lines and setbacks for sun shading devices, entry awnings and cornices are permissible.

### 1.22.2 Street Frontage Heights

#### Objectives

- (a) To strengthen the urban form of Oxford Street Mall with consistent street wall heights.
- (b) To achieve comfortable street environments for pedestrians in terms of daylight, scale, sense of enclosure and wind mitigation as well as a healthy environment for street trees.
- (c) To enhance the distinctive character of streets within Bondi Junction Centre.
- (d) To protect solar access to key streets and public spaces.

#### Controls

- (a) Buildings must comply with the relevant street frontage heights as shown in Figures 34 - 37
- (b) All new buildings and additions or alterations to existing buildings on the north side of Oxford Street Mall must comply with the sun access plane illustrated in Figures 35 and 36, irrespective of the existing height of nearby buildings.
- (c) The erection of a building so that any part of the building is above the envelope specified in the relevant sun access diagram is not permitted, unless that part of the building is a minor architectural roof feature.



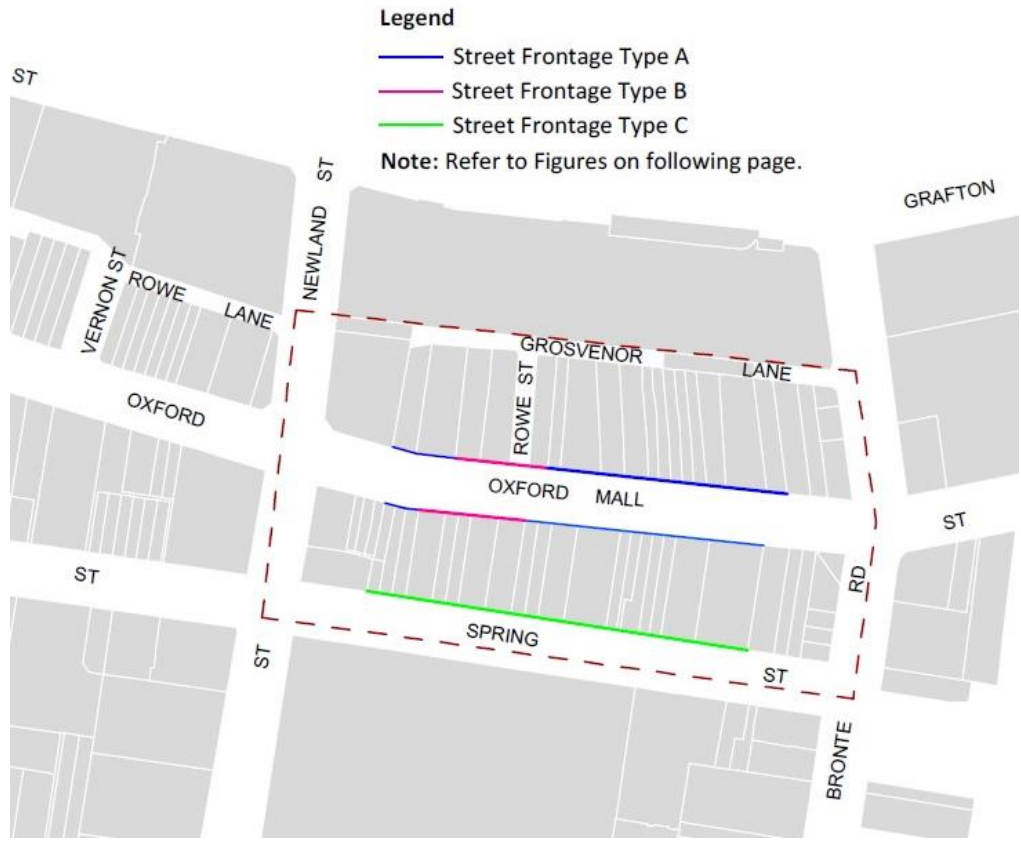


Figure 34 Street frontage heights

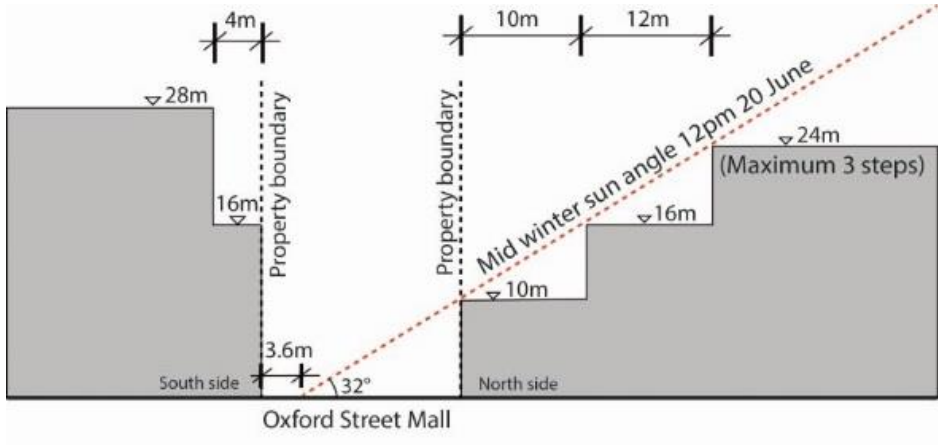


Figure 35 Street frontage Type A – Oxford Street Mall

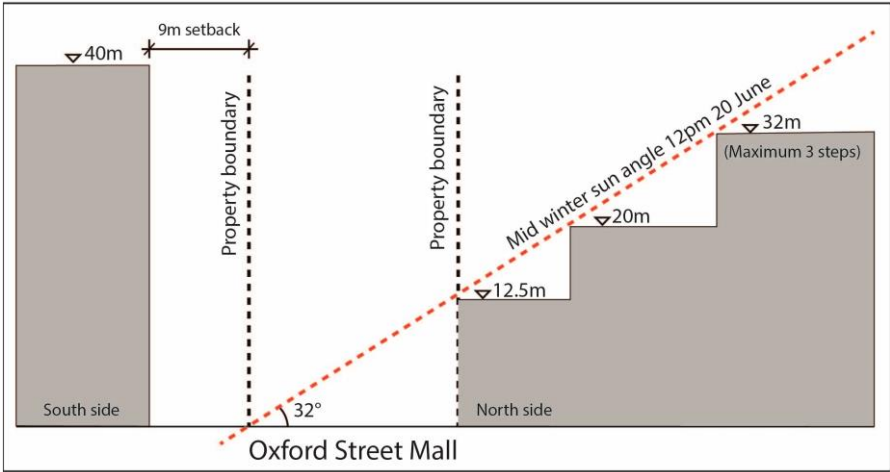


Figure 36 Street frontage Type B – Rowe Street

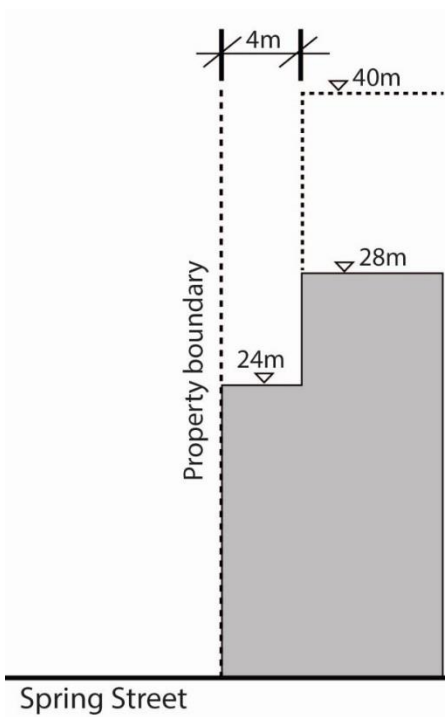


Figure 37 Street frontage Type C – Street frontage

### 1.22.3 Building Depth and Bulk

#### Objectives

- (a) To promote the design and development of sustainable buildings.
- (b) To promote living and working environments with good internal amenity and minimise the need for artificial heating, cooling and lighting.
- (c) To provide viable and useable commercial floor space.
- (d) To achieve usable and pleasant streets and public domain at ground level by controlling the size of upper level floor plates of buildings.
- (e) To allow for view sharing and view corridors.
- (f) To reduce the apparent bulk and scale of buildings by breaking up expanses of building wall with modulation of form and articulation of facades.

#### Controls

- (a) On land zoned E2 Commercial Centre, above street frontage height the preferred maximum floor plate area of a building is 1000m<sup>2</sup> GFA.
- (b) All points on an office floor should be no more than 10m from a source of daylight (e.g. window, atria, or light wells). The preferred depth for office floors with openings on one side is 10m. The preferred depth for office floors with openings on two opposite sides is 20m.
- (c) Use atria, light wells and courtyards to improve internal building amenity and achieve cross ventilation and/or stack effect ventilation.

### 1.22.4 Pedestrian Amenity

#### Objectives

- (a) To improve access in Oxford Street Mall area by providing new through site links and enhancing existing links as redevelopment occurs.
- (b) To ensure through site links have active frontages along their length where possible.
- (c) To provide for pedestrian amenity and safety.
- (d) To retain and further develop laneways and small spaces as useful and interesting pedestrian connections as well as for service access.

#### Controls

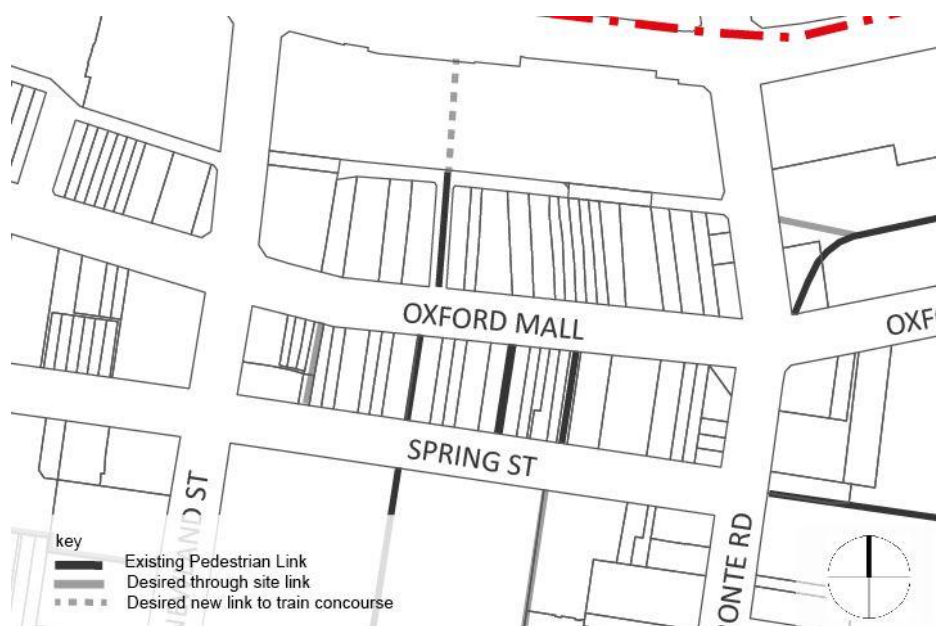
##### *General Controls*

- (a) Through site links, arcades, shared ways and laneways are to be provided as shown in Figure 38.
- (b) Retain all arcade connections and walkways.
- (c) Where possible, existing dead end lanes are to be extended through to the next street as redevelopment occurs and should provide clear sightlines from one end to the other.
- (d) New through site links should be connected with existing and proposed through site lanes, shared zones, arcades and pedestrian ways and opposite other through site links to enhance legibility to the whole laneway system.
- (e) Existing publicly and privately owned lanes are to be retained.

- (f) The design and finish of new through site links need to be provided in accordance with Council’s *Public Domain Technical Manual for Bondi Junction Centre*.

*Pedestrian links*

- (g) Through site links for pedestrians are to be provided as shown in Figure 38 and have active ground floor frontages; be legible and direct thoroughways for pedestrians; provide public access at all business trading times or as otherwise stipulated by Council’s conditions of approval; have a minimum width of 3m non-leasable space clear of all obstructions (including columns, stairs and escalators); where practicable, have access to natural light for at least 30% of their length; where air conditioned, have clear glazed entry doors comprising at least 50% of the entrance; have signage at street entries indicating public accessibility and the street to which the through site link connects; and maximise opportunities for integration of public art installations.
- (h) Internal arcades will not be approved in preference to activation of an existing or required lane. Where developments front a lane that is also a pedestrian route, provide an active frontage and design details that create visual interest such as landscaping, awnings, paved finishes and good lighting.
- (i) When a publicly accessible pedestrian connection is proposed to link directly to the railway line, Transport for NSW must approve connections to railway stations and approve designs. In addition, the developer will be required to enter into an agreement with Transport for NSW defining the controls to be implemented in managing access.
- (j) Due to its proximity to Bondi Junction Station and substantial foot traffic, Bronka Arcade is to have a minimum width of 6m, a minimum height of two storeys and have active frontages on both sides. (Note: A greater Floor Space Ratio and maximum building height is available for 153-165 Oxford Street in order to provide this through site link.)



**Figure 38** Through-site links

---

**1.22.5 Active Street Frontages and Address****Objectives**

- (a) To promote pedestrian activity and safety in the public domain.
- (b) To maximise active street fronts in Bondi Junction.
- (c) To define areas where active streets are required or are desirable.
- (d) To encourage an address to the street outside of areas where active street frontages are required.

**Controls***Active Street Frontages*

- (a) Provide active street frontages to all development identified in Figure 39 in accordance with *Part B16.2 Active Street Frontages*.

*Active frontage above Ground Floor*

- (b) Extend active frontages above ground floor level with uses and building design that provide transparency and visual contact with the street.
- (c) Integrate landscaping above ground floor levels to provide interest in design and amenity for uses of these spaces.

*Street Address*

- (d) Street address is defined as entries, lobbies, and habitable rooms with clear glazing to the street not more than 1.2m above street level and excluding car parking areas. Street address is required on Ground Level of all areas identified in Figure 39.
- (e) Provide multiple entrances for large developments including an entrance on each street frontage.

---

**1.22.6 Awnings****Objectives**

- (a) To increase pedestrian amenity by providing protection from wet weather and sunlight with awnings and colonnades.
- (b) To create a protected transition area between internal and external spaces for public and commercial buildings.
- (c) To improve pedestrian amenity by extending the footpath at ground floor level, and providing shelter and opportunities for outdoor dining.

**Controls**

- (a) Continuous street frontage awnings are to be provided for all new developments as indicated in Figure 39 in accordance with *B15.4 Awnings and Colonnades*.
- (b) Awning design must match building facades and be complementary to those of adjoining buildings.
- (c) Wrap awnings around corners for a minimum 6m from where a building is sited on a street corner.



Figure 39 Active street frontages required and front facade of buildings are to have awnings

1.22.7 Vehicle Footpath Crossings

Controls

Location of Vehicle Access

- (a) No additional vehicle entry points will be permitted into the parking or service areas of development along those streets identified in Figure 40.
- (b) In all other areas, one vehicle access point only (including the access for service vehicles and parking for non-residential uses within mixed use developments) will be generally permitted.

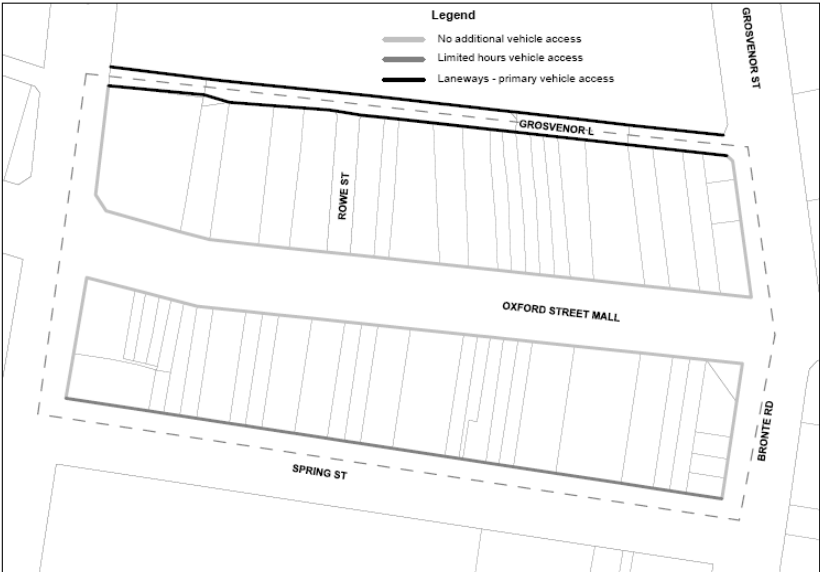


Figure 40 Vehicle access restrictions

---

**1.22.8 Building Exteriors****Objectives**

- (a) To contribute positively to the streetscape and public domain by means of high quality architecture and robust selection of materials and finishes.
- (b) To provide richness of detail and architectural interest especially at visually prominent parts of buildings such as lower levels and roof tops.
- (c) To present appropriate design responses to nearby development that complement the streetscape.
- (d) To clearly define the adjoining streets, street corners and public spaces and avoid ambiguous external spaces with poor pedestrian amenity and security.
- (e) To maintain a pedestrian scale in the articulation and detailing of the lower levels of the building.

**Controls**

- (a) Adjoining buildings (particularly heritage buildings) are to be considered in the design of new buildings in terms of: appropriate alignment and street frontage heights; setbacks above street frontage heights; appropriate materials and finishes selection; facade proportions including horizontal or vertical emphasis; and the provision of enclosed corners at street intersections.
- (b) Articulate façades so that these address the street and add visual interest.
- (c) External walls should be constructed of high quality and durable materials and finishes with 'self-cleaning' attributes, such as face brickwork, rendered brickwork, stone, concrete and glass.
- (d) Finishes with high maintenance costs, those susceptible to degradation or corrosion that result in unacceptable amenity impacts, such as reflective glass, are to be avoided.
- (e) To assist articulation and visual interest, avoid expanses of any single material.
- (f) Limit opaque or blank walls for ground floor uses to 30% of the street frontage.
- (g) Maximise glazing for retail uses, but break glazing into sections to avoid large expanses of glass.
- (h) Highly reflective finishes and curtain wall glazing are not permitted above ground floor level.
- (i) A materials sample board and schedule is required to be submitted with applications for development over \$1 million or for that part of any development built to the street edge.
- (j) The design of roof plant rooms and lift overruns is to be integrated into the overall architecture of the building.

---

**1.22.9 Site Facilities and Services****Objectives**

- (a) To ensure that site facilities are effectively integrated into the development and are unobtrusive.
- (b) To establish appropriate access and location requirements for servicing.
- (c) To ensure service requirements do not have adverse amenity impacts.



**Controls**

- (a) All site facilities are to be integrated into the design of the building.
- (b) For developments where a fire brigade vehicle is required to enter the site, vehicular access, egress and maneuvering must be provided to, from and on the site in accordance with the NSW Fire Brigades Code of Practice – Building Construction – NSWFB Vehicle Requirements. Generally, provision must be made for NSW Fire Brigade vehicles to enter and leave the site in a forward direction where: NSW Fire Brigade cannot park their vehicles within the road reserve due to the distance of hydrants from the building or restricted vehicular access to hydrants; or the site has an access driveway longer than 15m.

**1.22.10 Special Areas****Objectives**

- (a) The Rowe Street and Bronka Arcade sites, on the north and south sides of Oxford Street Mall, lie at the crossing of important pedestrian routes through Bondi Junction. These sites offer an opportunity to enliven Oxford Street Mall and the centre of the Bondi Junction Centre area more broadly, by activating the area through increased pedestrian traffic and enhanced permeability of the area.
- (b) On the Rowe Street site, a major new link is to be created between Oxford Street Mall and the railway interchange. This link will encourage greater pedestrian traffic on the Mall, improving the desirability of retail floor space in the Bondi Junction Centre.
- (c) On the Bronka Arcade site, existing connections are to be maintained and enhanced by a more generous, double height arcade connection to Spring Street.

**Controls***Built form*

- (a) On the Rowe Street site, new development must comply with the solar access plane illustrated in Figure 41, which ensures that new development on this site does not overshadow the Oxford Street Mall in winter. On the Bronka Arcade site, new development is permitted to rise to 40m from the 9m setback to Oxford Street Mall.

*Public Domain Interface*

- (b) In order to ensure a high quality interface with the retail frontage along its length, the covered arcade connecting Oxford Street Mall and the railway concourse/Tiffany Plaza development should have the same finished floor level as the mall, and should be level along its entire length. The connection down to the railway station and up to the Tiffany Plaza development should consist of escalators, stairs and a lift, contained within an arcade-style development with active frontages. Development on the Rowe Street site is to be serviced from Grosvenor Lane.
- (c) In order to encourage the activation of Spring Street, development on the Bronka Arcade site is to be serviced below ground, or on a limited hours basis from Spring Street.



(d) Because of limited opportunities for vehicle access, new developments are encouraged to consolidate parking.

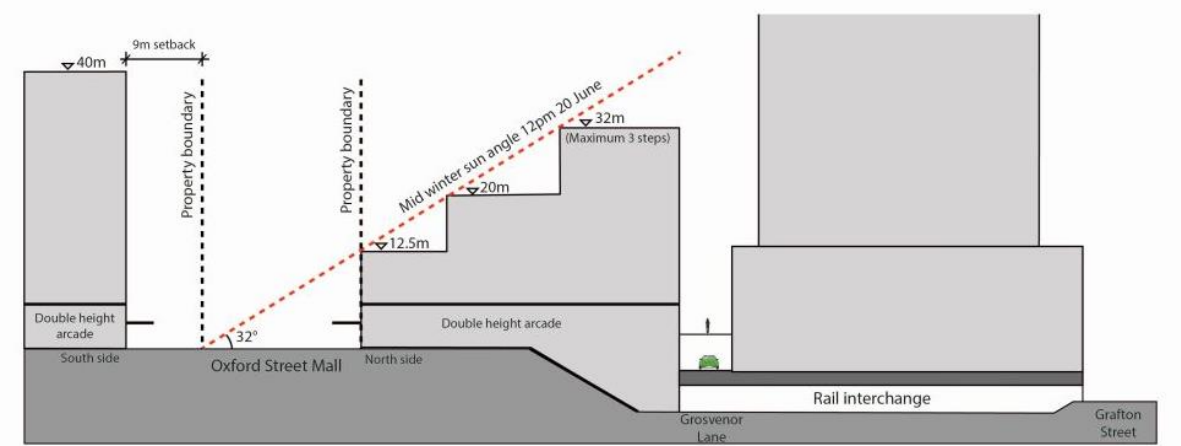


Figure 41 Section showing intended Transport Interchange Upgrade

## E2 BOND BEACHFRONT AREA

Bondi Beach is an iconic location, including one of Australia’s most famous beaches. Bondi Beach has local, state and national heritage significance and is a major tourist attractor as well as a popular spot for locals due to its eclectic character and services.

This Part plays an integral role in maintaining the area’s unique qualities while providing urban design controls for residential and commercial development including controls relating to building height, parking, setbacks and building appearance.

This Part applies to land located within the Bondi Beachfront Area.

This Part applies to the land commonly known as the Bondi Beachfront Area shaded in Figure 42.

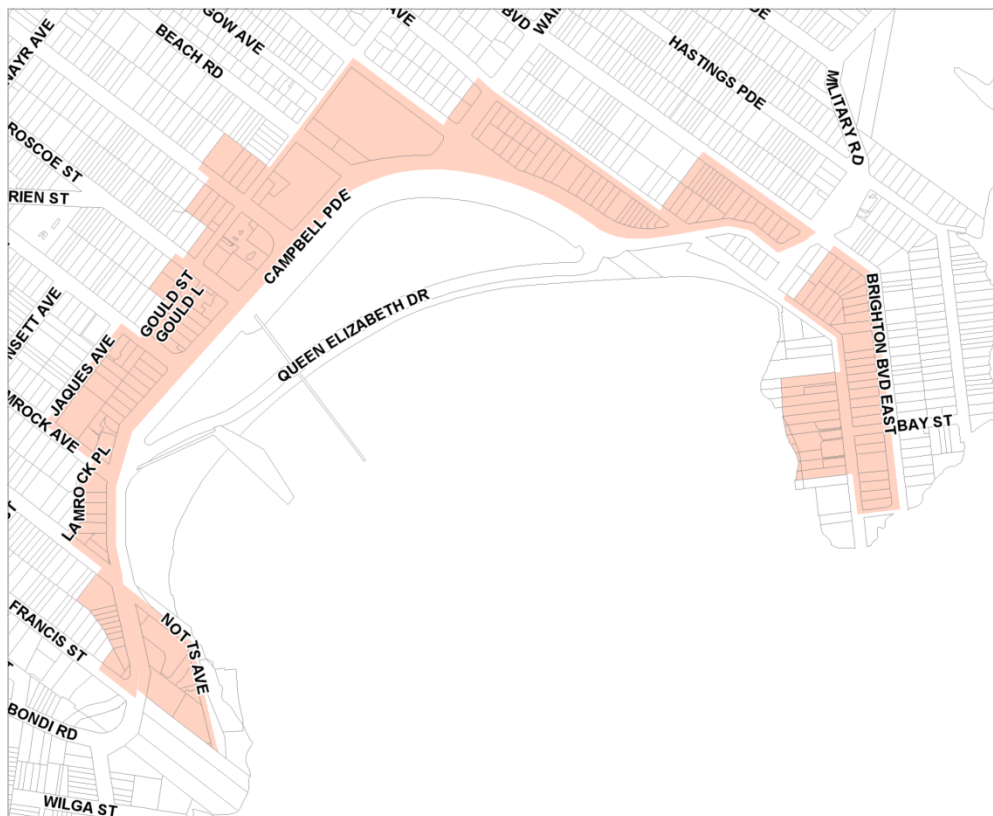


Figure 42 Bondi Beachfront Area Centre

This Part contains general objectives and controls for development within the Bondi Beachfront Area as well as specific objectives and built form controls for five (5) Character Areas. A development is required to meet the general objectives and controls as well as the specific objectives and built form controls for the area in which the development is located.

## 2.1 GENERAL CONTROLS

This section outlines the general objectives and urban design controls that apply to the Bondi Beachfront Area. Where required, these controls must be read in conjunction with *Part E3 Local Village Centres*.

The controls should also be read in conjunction with the design guidelines included in *Annexure E2-1* which provide examples of building elements. These are derived from an analysis of the existing buildings. These guidelines are intended to guide owners to develop in a way that contributes to, and enhances, the individual character of the Bondi Beachfront Area.

### 2.1.1 Public Domain Interface

#### Objectives

- (a) To ensure priority is given to pedestrian movement.
- (b) To encourage retail trading and appropriate commercial uses at street level.
- (c) To encourage development with a strong street address and well-defined residential entries.
- (d) To ensure ground level building frontages are active, open, inviting and that shop fronts are maximised.
- (e) To provide continuous awnings for pedestrians in E1 Local Centre Zones.
- (f) To maintain the small shop character at ground floor in E1 Local Centre Zones.
- (g) To encourage publicly accessible through-site pedestrian access ways within E1 Local Centre Zones.
- (h) To provide safe pedestrian environments through reduced vehicular crossings on primary commercial streets.

#### Controls

- (a) Development must be sensitive to the streetscape character and views. A streetscape and context analysis is to be provided in accordance with Part B11 Design Excellence.
- (b) All development to which this Part applies is to provide active street frontages in accordance with *Part B15.2 Active Street Frontages*.
- (c) Buildings must have a clear street address with well-defined entries that are visible from the street.
- (d) Commercial and residential entries must be separated.
- (e) Access to residential dwellings above ground level should not occupy more than 20% of the principal street frontage.
- (f) New shop fronts must have proportions and characteristics that are consistent with other shop fronts in the Bondi Beachfront Area.
- (g) Shop fronts must consist primarily of clear glazing that is capable of opening to the public domain.
- (h) Opaque facades at ground level are not permitted in E1 Local Centre Zones.
- (i) Primary commercial street frontages must provide an entry to a retail premises every 5 - 6.5m
- (j) Vehicular entries are not permitted along Campbell Parade and primary commercial street frontages.

- (k) Pedestrian through-site access links are encouraged.

---

### 2.1.2 Building use

#### Objectives

- (a) To recognise the local role of the Bondi Beachfront Area.
- (b) To ensure that the Bondi Beachfront Area is not dominated by commercial and retail activity.
- (c) To ensure that the Bondi Beachfront Area maintains a high level of vibrancy.
- (d) To ensure that the Bondi Beachfront Area is afforded a high level of passive surveillance at all times.
- (e) To ensure continuous and active street frontages.

#### Controls

- (a) Consent must not be granted for development in relation to the use of a building erected or proposed to be erected on land in the Bondi Beachfront Area, if the Council is of the opinion that any part of a floor above the first floor will be used for the purpose of a Business Premises or Office Premises.
- (b) The ground floor and first floor of any development that is a building on land zoned E1 Local Centre in the Bondi Beachfront Area as identified on the Area Map must have active street frontages and be used for retail premises, business premises, tourist and visitor accommodation or a combination of those uses.
- (c) The ground floor of any development that is a building on land zoned E1 Local Centre in Hall Street or Curlewis Street must have active street frontages and be used for retail premises, business premises, or a combination of both.

---

### 2.1.3 Built Form

#### Objectives

- (a) To ensure new and refurbished buildings are sympathetic to the scale and height of existing buildings.
- (b) To reinforce the prevailing street pattern of rectilinear building forms as well as predominantly vertical proportions of bay openings and windows.
- (c) To maintain the existing building line abutting the street alignment along Campbell Parade.
- (d) To ensure built form does not negatively impact on the access to sunlight in public open spaces.
- (e) To ensure buildings provide high quality internal environments for occupants and users of the building, both residential and non-residential uses.
- (f) To maintain the scale and alignment of the existing predominant street wall.

#### Controls

- (a) The built form of new and refurbished buildings must complement the height and scale of the prevalent built form within the Bondi Beachfront Area.
- (b) Where a building façade adjoins a heritage item or a contributory building, it must have a façade that complements the form and proportion of the building.

- (c) Buildings along Campbell Parade must be built to the street alignment and predominant surrounding street wall height.
- (d) Attic levels must be wholly contained within a hipped or gabled roof form, and should be setback a minimum of three metres from the principal façade and not encroach into the setback line.
- (e) External sun shading must be consistent with the style and articulation of the building. Sun shading must not project beyond the principal façade.
- (f) For non-residential uses, habitable floorspace should be more than 10m from a window.
- (g) Buildings in the E1 Local Centre zone must provide a minimum of 3.3m clear ceiling heights on Ground Level and Level 1.
- (h) Corner sites require architectural treatment which emphasizes the prominent role filled by these sites. Measures include the deletion of upper floor setbacks with construction to external site boundaries, design measures to emphasize the corner and improvement to the public domain.
- (i) Openings to new balconies in existing facades should not exceed the width of existing openings and make use of existing openings where possible.
- (j) Voids or gaps in the street wall should be avoided.
- (k) For sites adjoining residential zoned land, the building is to be setback a minimum of 1.5m from the common boundary.
- (l) Commercial and retail buildings are to comply with the following:
  - (i) Minimum floor to ceiling height of 3.6m above ground floor,
  - (ii) Minimum 4m floor to ceiling height at ground floor.

---

**2.1.4 Roofs****Objectives**

- (a) To maintain the established roof-scape along Campbell Parade.
- (b) To ensure rooftop elements are cohesive with the existing streetscape and their roof mounted services are concealed from and do not dominate roof-scapes viewed from Campbell Parade, Bondi Beach or the public domain.
- (c) Encourage solar collectors and photovoltaic cells to be integrated into the overall design of roof terraces.
- (d) To ensure that balconies and balcony or roof top additions do not substantially alter heritage items or contributory buildings.

**Controls**

- (a) The existing pattern of roof forms and roof elements along Campbell Parade must be retained.
- (b) Rooftop elements and buildings services located on the roof of a building must not be visible at eye level, 1.5m above the existing finished ground level, when viewed from the property boundary opposite the site.

---

**2.1.5 Views****Objectives**

- (a) To protect and enhance views from the public domain.
- (b) To minimise view loss from existing developments by proposed development.
- (c) To promote the concept of view sharing as a means of ensuring equitable access to views.

**Controls**

- (a) Proposed development must respect existing view corridors from the public domain.
- (b) Proposed development should avoid impacting on existing views where possible.
- (c) Trees are not permitted from being planted where they would take away an existing view from the habitable room or balcony of an existing building when mature.

---

**2.1.6 Heritage Conservation**

*Part B8 Heritage* applies for the Bondi Beachfront Area.

**Objectives**

- (a) To protect and enhance heritage items, contributory buildings and the established character of the heritage urban conservation area.
- (b) To enable ongoing adaptive reuse of heritage items and contributory buildings where existing usage is no longer viable.

- (c) To ensure retention and restoration of detailing to heritage items and contributory buildings including street level shopfronts and entry lobbies to residential flat buildings.
- (d) To ensure heritage items and contributory buildings are retained and remain legible as individual buildings in new developments.

#### Controls

- (a) Heritage items and contributory buildings are nominated on the Heritage Items and Contributory Buildings Maps provided for each Character Area in *Part E2.2 Character Areas*.
- (b) Heritage items and contributory buildings are to be retained and to remain legible as individual buildings in any related development.
- (c) Heritage items and contributory buildings may be adaptively reused where existing usage is no longer viable.
- (d) Adaptive reuse of heritage items and contributory buildings is to maintain the form, detail and finishes of the existing buildings as the dominant aspect of the site with new works having limited impact upon the significance and contribution of the building to the conservation area.
- (e) Any works adjacent to or in the context of heritage items and contributory buildings must clearly demonstrate cohesion with the existing historic character of the streetscape and the form, alignment, detailing, articulation and materials of heritage items and contributory buildings defining the conservation area.
- (f) Where upper storey additions are proposed to heritage items or contributory buildings that have pitched roofs, attic additions are to be utilised in lieu of additional expressed floors.

#### 2.1.7 Infill Buildings

*Part B8 Heritage* also applies for the Bondi Beachfront Area

#### Objectives

- (a) To encourage infill buildings sympathetic in style to heritage items and contributory buildings in the Bondi Beachfront Area.
- (b) To discourage infill buildings from imitating characteristics of heritage items and contributory buildings.

#### Controls

- (a) Infill buildings must not imitate decorative details or features of heritage item and contributory buildings.
- (b) Fenestrations must have similar proportions to heritage items and contributory buildings within the Bondi Beachfront Area.
- (c) Where a new building is located adjacent to heritage items or contributory buildings, its design must be sympathetic in scale, alignment, detailing and materials to these existing buildings.
- (d) Infill buildings must build to the prevailing street wall height then setback a minimum of 3m to any upper floors.

## 2.2 CHARACTER AREAS

The Bondi Beachfront Area contains a number of areas that contain similar characteristics and development potential and are known as Character Areas as shown in Figure 43 and includes:

- A - Notts Avenue;
- B - Campbell Parade South;
- C - Campbell Parade Centre;
- D - Campbell Parade North; and
- E - Ramsgate Avenue East.

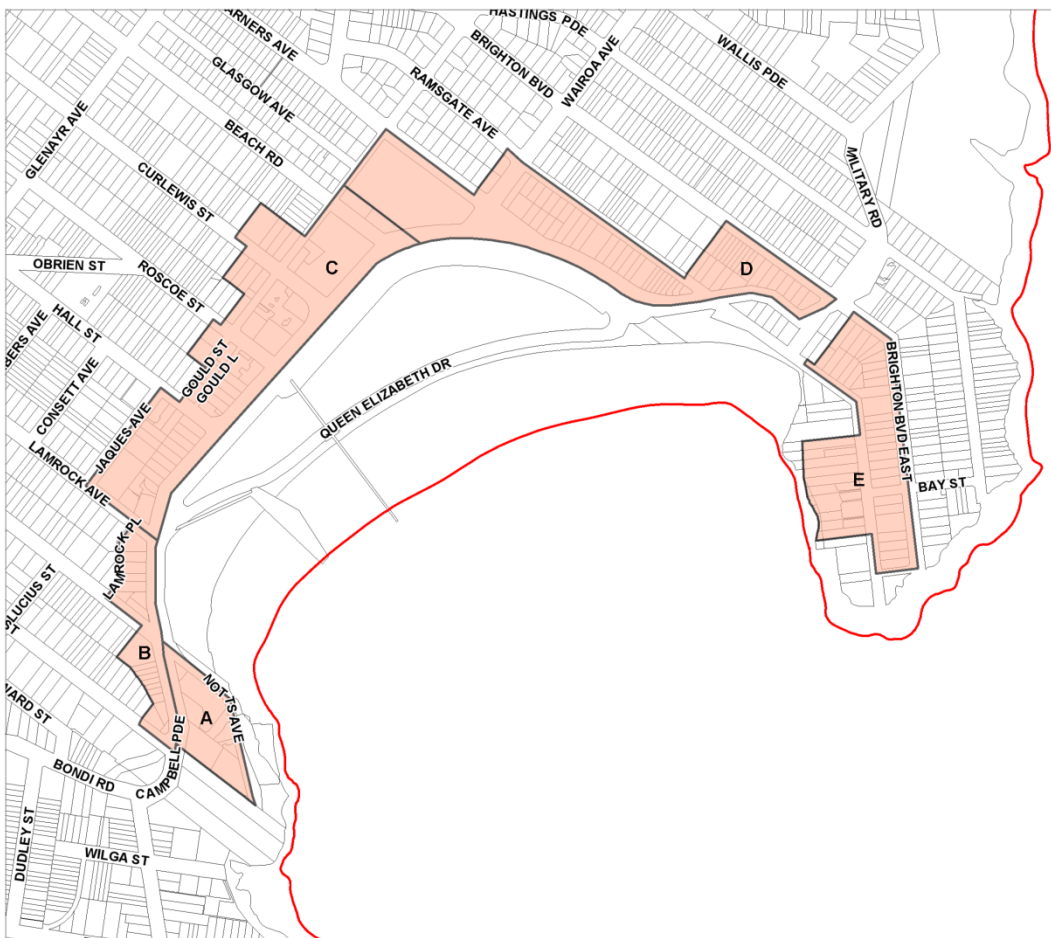


Figure 43 Character Areas



### 2.2.1 Notts Avenue

#### Existing Character and Built Form

Notts Avenue is a residential area comprising a variety of housing forms including street defining residential flat buildings along Notts Avenue and a tower on top of the headland along Campbell Parade (refer to Figure 39). Buildings are generally oriented to the north to take advantage of the aspect and elevated views over Bondi Beach. It has an irregular subdivision pattern.

Existing buildings in this area are predominantly rendered masonry with flat and pitched roofs. Buildings have a variety of expressions from the strongly horizontal emphasis of the building at the corner of Notts Avenue and Campbell Parade to vertical flat buildings.

Notts Avenue is characterised by blank street walls and a raised pedestrian footway at ground level with some garage openings and buildings located on top of a sloping topography. The Campbell Parade frontage is not street defining and contains residential uses at ground level.



Figure 44 Notts Avenue Character Area

**Desired Future Character Objectives**

- (a) To maintain a residential character and support a diversity of residential accommodation in the area.
- (b) To ensure that vehicular entries do not dominate Notts Avenue.
- (c) To retain established building levels along Notts Avenue.
- (d) To encourage buildings along Campbell Parade and Notts Avenue to be built to the street edge with no setbacks.

**Controls**

- (a) Land use
  - (i) Developments are to retain the predominantly residential character of the area.
  - (ii) Developments fronting Campbell Parade are encouraged to have active ground floor frontages with retail.
- (b) Height and Bulk
  - (i) A maximum of 3 storeys is permitted.
  - (ii) A maximum external wall height of 10m is permitted.
- (c) Setbacks
  - (i) Buildings fronting Campbell Parade are to be built to the street edge with no setbacks.
  - (ii) Buildings are to provide sufficient rear setbacks to provide courtyards.
  - (iii) Buildings fronting Campbell Parade must have zero side setbacks for min. 10m from the Campbell Parade street wall for the height of the street wall.
- (d) Façade Materials and Finishes
  - (i) Blank, flat and unarticulated facades are not permitted.
  - (ii) Buildings must not use materials that are highly reflective.
  - (iii) Windows must be composed as part of the overall form of the building.
  - (iv) Dark or tinted glazing is not permitted.
- (e) Balconies and Balustrades
  - (i) Balconies along Campbell Parade must be recessed into the building envelope and should not project forward of the principal façade.
  - (ii) Balconies along Campbell Parade must be screened.
  - (iii) Balconies adjacent to a public open space or on side boundaries must be screened.
  - (v) Balconies must be designed as part of the overall form of the building.

- (f) External Sun Shading
  - (i) External sun shading must be constructed of materials that are suitable to the environmental conditions of the site.
  - (ii) External sun shading must be consistent with the style and articulation of the building.
  
- (g) Roofs and Parapets
  - (i) Roofs must be flat and edged by parapets along Campbell Parade and at the corners with Notts Avenue and Hunter Park for 10 metres back from the corner.
  
- (h) Façade Colours
  - (i) Light to mid colours must be used.
  - (ii) Dark colours are not permitted.
  
- (i) Awnings
  - (i) Awnings are required along Campbell Parade.
  
- (j) Parking
  - (i) Car parking should be located below ground level and should not be visible from the street.
  - (ii) Car parking access via Campbell Parade is not permitted.
  - (iii) Car parking at or above ground level is discouraged. If there is no alternative - it should be screened behind habitable uses to a minimum depth of 8 metres. Car parking must not be visible from the street or from a public place

### 2.2.2 Campbell Parade South

#### Existing Character and Built Form

Campbell Parade is the principal street that follows the curve of Bondi Beach and is an integral element of the tourist image, providing retail, food and other services for the transient day/night time population, short-term residents and local community (refer to Figure 45). A regular pattern of secondary streets run perpendicular to Bondi Beach, creating visually prominent corners at Francis Street, Sir Thomas Mitchell Road and Lamrock Avenue. The land slopes steeply from Sir Thomas Mitchell Road to the top of the southern headland at Hunter Park.

Existing buildings have narrow frontages built to the street alignment, with notable facades that contribute to its Interwar heritage. Buildings are predominantly rendered masonry with parapets and a vertical expression through the use of bay or vertically proportioned windows, pilasters and a few balconies, typically enclosed. Existing buildings generally have a north-eastern orientation that takes advantage of the aspect and views over Bondi Beach.

Many sites contain heritage items and a large proportion of the area is located within the heritage urban conservation area. Many sites contain contributory buildings worthy of retention as they contribute to the overall character of the Area. These buildings are generally intact and consistent with other 1920s/30s precincts in Sydney.



Figure 45 Campbell Parade South Character Area

**Desired Future Character Objectives**

- (a) To support and maintain the iconic role and unique character of the Campbell Parade retail strip as a separate area within the wider Bondi Beach Town Centre in providing local shops, services and residential accommodation for day visitors and the local community.
- (b) To maintain the mixed-use character of the centre by locating small shops and services at ground level and level one with a diversity of residential accommodation above.
- (c) To encourage outdoor seating on top of awnings along Campbell Parade.
- (d) To ensure new development and major renovations are consistent with the existing character of the area.
- (e) To encourage development that addresses the street and is built to the street alignment along Lamrock Place.

**Controls**

- (a) Land use
  - (i) Developments are to retain the mixed use character of the area by locating commercial at ground and level 1 and residential above.
- (b) Height and Bulk
  - (i) A maximum of 4 storeys is permitted.
  - (ii) A maximum external wall height of 12.5m is permitted.
- (c) Setbacks
  - (i) Buildings are to be built to the street edge with no setbacks.
  - (ii) Buildings are to be built to the side boundaries for minimum 10m from the front street wall.
  - (iii) Balconies and terraces may extend over the ground floor awning where commercial is proposed.
  - (iv) Where a building is to be extended by the construction of additional floors, the new section is to be setback from the existing façade line by a minimum distance of 3m.
  - (v) Attic levels or part additional floors must be setback minimum 3 metres from the street wall.
- (d) Heritage and contributory buildings
  - (i) Maintain the existing character of the area including narrow frontages and vertical expression.
  - (ii) Where a building is to be constructed in conjunction with a retained façade, the new construction is to be setback and integrated with the preserved section of the building.
  - (iii) Corner sites require architectural treatment which emphasises the prominent role filled by these sites in the urban context.
- (e) Façade Materials and Finishes
  - (i) New facades must be predominately rendered masonry with parapets and have a vertical expression.
  - (ii) Blank, flat and unarticulated facades are not permitted.

- (iii) Access to residential dwellings above ground level should not occupy more than 20% of the principal street frontage of any development.
  - (iv) Developments on corner sites are to be designed to accentuate the corner and provide a transition between one streetscape and the next.
  - (v) Windows above ground level must have vertical proportions.
  - (vi) Windows should be integral with the façade and not applied decoration.
  - (vii) Dark or tinted glazing is not permitted.
- (f) **Balconies and Balustrades**
  - (i) Balconies along Campbell Parade must be recessed into the building envelope and should not project forward of a principal façade.
  - (ii) Balustrades along Campbell Parade, must be predominantly solid with no or minimal glazing.
  - (iii) Balconies must be composed as part of the overall form of the building.
- (g) **External Sun Shading**
  - (i) External sun shading must be constructed of materials that are suitable to the environmental conditions of the site.
  - (ii) External sun shading must be consistent with the style and articulation of the building.
  - (iii) Sun shading must not project beyond the principal façade.
- (h) **Roofs and Parapets**
  - (ii) Parapets must be predominantly rendered masonry.
  - (iii) Roofs must be flat with parapets.
  - (iv) Roofs must not be visible from Campbell Parade, unless there is a contextual reason for providing a pitched roof to relate to an adjacent heritage item or contributory building.
  - (v) The roofline of buildings, predominately comprising lift motor rooms and plant rooms shall be designed as an integral part of the buildings architectural form.
- (i) **Façade Colours**
  - (i) Colours should be consistent with, retained or reinstated on heritage items and contributory buildings (refer to *Annexure E2-1*).
  - (ii) Light to mid colours must be used on all other buildings.
  - (iii) Dark colours are not permitted.
- (j) **Parking**
  - (i) Vehicle entries are not permitted along Campbell Parade.
  - (ii) Where parking is permitted, it should be located below ground level and should not be visible from the street.

### 2.2.3 Campbell Parade Centre

#### Existing Character and Built Form

Campbell Parade is the principal street that runs parallel to Bondi Beach. Gould Street and Jacques Avenue are secondary streets that run parallel to Campbell Parade (refer to Figure 46). A regular pattern of secondary streets run perpendicular to Campbell Parade, creating visually prominent corners at Lamrock Avenue, Hall Street, Curlewis Street and Beach Road.

Campbell Parade is an integral element of the tourist image, providing retail, food and other services for the transient day/night time population and local community. Gould Street is an increasingly vibrant secondary street, providing specialist retail for visitors and the surrounding neighbourhood.

Buildings between Roscoe Street and Lamrock Avenue have narrow frontages and are built to the street alignment, with notable facades that contribute to its Interwar heritage. These buildings are predominantly rendered masonry with parapets with a vertical expression through the use of bay or vertically proportioned windows, pilasters and few balconies, typically enclosed. Existing buildings generally have a south-eastern orientation that takes advantage of the views over Bondi Beach, generally without balconies.

Many sites contain heritage items or contributory buildings and a large proportion of the area is located within the heritage urban conservation area. These buildings are generally intact and consistent with other 1920s/30s precincts in Sydney.



Figure 46 Campbell Parade Centre Character Area

**Desired Future Character Objectives**

- (a) To support and maintain the iconic role and unique character of the Campbell Parade retail strip as a separate area within the wider Bondi Beach Town Centre in providing local shops, services and residential accommodation for day visitors and the local community.
- (b) To increase access links between Campbell Parade and Gould Street to encourage pedestrian movement that supports local shops and increase the retail frontage.
- (c) To maintain the mixed-use character in the centre by locating small shops and services at ground level and level one with a diversity of residential accommodation above.
- (d) To ensure new development and major renovations are consistent with the existing character of the area.
- (e) To minimise heritage impacts on identified heritage items and conservation areas within this and adjoining areas.

**Controls**

- (a) Land use
  - (i) Developments are to retain the mixed use character of the area by locating commercial at ground and 1<sup>st</sup> floor level and residential above.
  - (ii) New developments should provide pedestrian through site access links between Campbell Parade and Gould Street.
- (b) Height and Bulk
  - (i) A maximum of 4 storeys is permitted except for buildings fronting Curlewis Street, Beach Road or the western side of Gould Street where a maximum of 3 storeys is permitted.
  - (ii) A maximum external wall height of 12.5m is permitted except for buildings fronting Curlewis Street, Beach Road or the western side of Gould Street where a maximum of 10m is permitted.
  - (iii) An attic level or part additional floor may be permitted.
- (c) Setbacks
  - (i) Buildings within the E1 Local Centre zone are to be built to the street edge with no setbacks.
  - (ii) Buildings are to be built to the side boundaries for a minimum of 10m from the front street wall
  - (iii) Where a building is to be extended by the construction of additional floors, the new section is to be setback from the existing façade line by a minimum distance of 3m.
  - (iv) Attic levels or part additional floors must be setback minimum 3 metres from the street wall.
- (d) Heritage and contributory buildings
  - (i) Maintain the existing character of the area including narrow frontages and vertical front facade expression.
  - (ii) Where a building is to be constructed in conjunction with a retained façade, the new construction is to be similarly setback and integrated with the preserved section of the building.



- (iii) Corner sites require architectural treatment which emphasises the prominent role filled by these sites in the urban context.
- (e) Façade Materials and Finishes
  - (i) New facades must be predominately rendered masonry with solid parapets and have a vertical expression.
  - (ii) Blank, flat and unarticulated facades are not permitted.
  - (iii) Access to residential dwellings above ground level should not occupy more than 20% of the principal street frontage of any development.
  - (iv) Developments on corner sites are to be designed to accentuate the corner and provide a transition between one streetscape and the next.
  - (v) Fenestrations above ground level must have a vertical proportion, unless the existing character is otherwise.
  - (vi) Dark or tinted glazing is not permitted.
- (f) Balconies and Balustrades
  - (i) Balconies along Campbell Parade must be recessed into the building envelope and should not project forward of a principal façade.
  - (ii) Balustrades along Campbell Parade, must be predominantly solid with no or minimal glazing.
  - (iii) Balconies adjacent to a public open space or on side boundaries must be screened.
  - (iv) Balconies must be composed as part of the overall form of the building.
- (g) External Sun Shading
  - (i) External sun shading must be constructed of materials to suit the environmental conditions of the site.
  - (ii) External sun shading must be consistent with the style and articulation of the building. Sun shading must not project beyond the principal façade.
- (h) Roofs and Parapets
  - (i) Parapets must be predominantly rendered masonry.
  - (ii) Roofs must be flat with parapets.
  - (iii) Roofs must not be visible from Campbell Parade, unless there is a contextual reason for providing a pitched roof to relate to an adjacent heritage item or contributory building.
  - (iv) The roofline of buildings, predominately comprising lift motor rooms and plant rooms shall be designed as an integral part of the buildings architectural form.
- (i) Façade Colours
  - (i) Colours should be consistent with, retained or reinstated on heritage items and contributory buildings (refer to *Annexure E2-1*).
  - (ii) Light to mid colours must be used on all other buildings.
  - (iii) Dark colours are not permitted.
- (j) Awnings
  - (i) New awnings must step to reflect the topography.
- (k) Parking
  - (i) Vehicle entries are not permitted along Campbell Parade.

- (ii) Parking should be located below ground level and should not be visible from the street.

### 2.2.4 Campbell Parade North

#### Existing Character and Built Form

Campbell Parade is the principal street that follows the gentle curve of Bondi Beach. A regular pattern of secondary streets runs perpendicular with the Campbell Parade retail strip. The land is steeply sloping towards Dover Heights and the secondary streets generally run along the contours (refer to Figure 47).

This area has a variety of building types including dwelling-houses, townhouses and residential flat buildings. Shop-top housing is generally located towards the corners.

Existing buildings along Campbell Parade have narrow frontages and are built to the street alignment, with notable facades that contribute to its Interwar heritage. Many sites contain contributory buildings which contribute to the overall character of the Area. These buildings are generally intact and consistent with other 1920s/30s precincts in Sydney.

Existing buildings are predominantly rendered masonry with parapets with a vertical expression through the use of bay or vertically proportioned windows, pilasters and few balconies, typically enclosed.

Buildings are generally oriented to the south to take advantage of the view over Bondi Beach, with some balconies. The orientation and narrow frontages limit solar access and cross ventilation.



Figure 47 Campbell Parade North

**Desired Future Character Objectives**

- (a) To support the unique mixed use character of this section of Campbell Parade.
- (b) To discourage residential accommodation at street level along Campbell Parade.
- (c) To ensure new development and major renovations are consistent with the existing character of the area.
- (d) To ensure development is built to the street with no setbacks along Campbell Parade.

**Built Form Controls**

- (a) Land use
  - (i) Developments are to retain the predominantly residential character of the area with retail at street level encourages with properties fronting Campbell Parade.
- (b) Height and Bulk
  - (i) A maximum of 4 storeys is permitted.
  - (ii) A maximum external wall height of 12.5m is permitted.
  - (iii) An attic level or part additional floor may be permitted.
  - (iv) New buildings must address the character of adjoining buildings and generally reproduce the side setbacks, bulk and scale of adjoining built form.
- (c) Setbacks
  - (i) Buildings with frontages to Campbell Parade are to be built to the street edge with no setbacks.
  - (ii) Buildings with frontages to Ramsgate Avenue and Brighton Boulevard are to have a front setback of 3m.
  - (iii) Buildings are to provide front and rear setback back for floors above street level to provide balconies.
  - (iv) Balconies and terraces may extend over the ground floor awning where commercial is proposed.
  - (v) Where a building is to be extended by the construction of additional floors, the new section is to be setback from the existing façade line by a minimum distance of 3m.
- (d) Façade Materials and Finishes
  - (i) New facades must be predominately rendered masonry with parapets and have a vertical expression.
  - (ii) Blank, flat and unarticulated facades are not permitted.
- (e) Heritage and contributory buildings are to conform to the following controls:
  - (i) Maintain the existing character of the area including narrow frontages and vertical front facade expression.
  - (ii) Where a building is to be constructed in conjunction with a retained façade, the new construction is to be similarly setback and integrated with the preserved section of the building.
  - (iii) Existing face brick building exteriors should be retained and not painted or rendered.

- (f) Façade Materials and Finishes
  - (i) New facades must be predominately rendered masonry with parapets and have a vertical expression.
  - (ii) Blank, flat and unarticulated facades are not permitted.
  - (iii) Buildings within the visual catchment of Bondi Beach must not use materials that are highly reflective.
  - (iv) Windows above ground level must have a vertical proportion.
  - (v) Dark or tinted glazing is not permitted.
  
- (g) Balconies and Balustrades
  - (i) Balconies along Campbell Parade must be recessed into the building envelope and should not project in front of a principal façade.
  - (ii) Balustrades along Campbell Parade, must be predominantly solid with no or minimal glazing.
  - (iii) Balconies adjacent to a public open space or on side boundaries must be screened.
  - (iv) Balconies must be composed as part of the overall form of the building.
  
- (h) External Sun Shading
  - (i) External sun shading must be suitable to the environmental conditions of the site.
  - (ii) External sun shading must be consistent with the style and articulation of the building. Sun shading must not project beyond the principal façade.
  
- (i) Roofs and Parapets
  - (i) Parapets must be predominantly rendered masonry.
  - (ii) Roofs must be flat with parapets.
  - (iii) Roofs must not be visible from Campbell Parade, unless providing a pitched roof relates to an adjacent heritage item or contributory building.
  - (iv) The roofline of buildings, predominately comprising lift motor rooms and plant rooms shall be designed as an integral part of the buildings architectural form.
  
- (j) Façade Colours
  - (i) Colours must be consistent with, retained or reinstated on heritage items and contributory buildings (refer to *Annexure E2-1*).
  - (ii) Light to mid colours must be used on all other buildings.
  - (iii) Dark colours are not permitted.
  
- (k) Awnings
  - (i) Awnings must be provided where there are retail uses at ground floor.
  
- (l) Parking
  - (i) Vehicle entries are not permitted along Campbell Parade.
  - (ii) Parking should be located below ground level and should not be visible from the street.
  - (iii) Car parking should not take the place of shop fronts at street level.

### 2.2.5 Ramsgate Avenue East

#### Existing Character and Built Form

The area generally has a regular subdivision pattern with narrow frontages to the street. It is a residential area comprising a variety of housing including dwelling-houses, two to three storey townhouses and residential flat developments. Buildings are generally oriented towards the west to take advantage of the elevated views over Bondi Beach. There is some shop-top housing at the western Ramsgate Avenue East, opposite Biddigal Reserve.

Existing buildings in this area are predominantly masonry, rendered and face brick, with pitched roofs but there are some flat and curved roofs. They have a variety of expressions with large fenestrations to the west and balconies are common. There are no heritage items in the area and it is located outside the heritage urban conservation area. Many sites contain buildings that are worthy of retention as they contribute to the overall character of the Area.

Brighton Avenue East has wide landscape strip with street trees with buildings setback from the street (refer to Figure 48).



**Figure 48** Ramsgate Avenue East Character Area

**Desired Future Character Objectives**

- (a) To maintain the residential character of the area and support a diversity of residential accommodation, with some shops at ground level opposite Biddigal Reserve.
- (b) To encourage development to address the street on the low-side of Ramsgate Avenue East.
- (c) To encourage built form with a vertical expression, constructed primarily of masonry with a consistent street wall height and attic levels setback from the street with balconies.
- (d) To discourage uncovered car parking and carports within the front setback.
- (e) To ensure that balconies and bay windows on side boundaries maintain visual and acoustic privacy between buildings.
- (f) To encourage balconies and operable screens that are integrated into the overall design of the building and that are constructed of materials appropriate to the exposed site conditions.
- (g) To maintain existing building setbacks.
- (h) To maintain and enhance existing view corridors.

**Built Form Controls**

- (a) Land use
  - (i) Developments are to retain the residential character of the area.
- (b) Height and Bulk
  - (i) A maximum of 3 storeys is permitted for buildings fronting Ramsgate Avenue and Brighton Boulevard.
  - (ii) Additional storeys are permitted where properties have dual frontage to Ramsgate Avenue East and the Coastline or where the topography permits.
  - (iii) An attic level or part additional floor may be permitted.
- (c) Setbacks
  - (i) Buildings are to have a minimum front setback equal to the average setback of the adjoining two houses on each side and 3m for properties fronting Ramsgate Avenue East.
  - (ii) Buildings are to provide rear setbacks for floors above street level to provide balconies. Where a building is to be extended by the construction of additional floors, the new section is to be setback from the existing façade line by a minimum distance of 3m.
- (d) Façade Materials and Finishes
  - (i) New facades must be predominately rendered masonry with a vertical expression.
  - (ii) Blank, flat and unarticulated facades are not permitted.
  - (iii) Buildings within the visual catchment of Bondi Beach must not use materials that are highly reflective.
- (e) Heritage items and contributory buildings
  - (i) Maintain the existing character of the area including narrow frontages and vertical expression.

- (ii) Where a building is to be constructed in conjunction with a retained façade, the new construction is to be similarly setback and integrated with the preserved section of the building.
  - (iii) Existing face brick building exteriors should be retained and not painted or rendered.
- (f) Fenestrations
- (i) Fenestrations must have a vertical proportion.
  - (ii) Dark or tinted glazing is not permitted.
  - (iii) Fenestrations along a side boundary must ensure visual and acoustic privacy is maintained between buildings.
- (g) Balconies and Balustrades
- (i) Balustrades fronting the coastline must be predominantly solid with no or minimal glazing.
  - (ii) Balconies must be composed as part of the overall form of the building.
  - (iii) Multiple balconies must be arranged with a vertical expression.
  - (iv) Balconies along the coastline must be recessed into the building envelope and should not project in front of the principal façade.
  - (v) Balconies adjacent to a public open space or on side boundaries must be screened.
- (h) External Sun Shading
- (i) External sun shading must be consistent with the style and articulation of the building.
  - (ii) Sun shading must not project beyond the principal façade.
- (i) Roofs and Parapets
- (i) The roofline of buildings, predominately comprising lift motor rooms and plant rooms shall be designed as an integral part of the buildings architectural form.
- (j) Façade Colours
- (i) Colours should be consistent with, retained or reinstated on heritage items and contributory buildings (refer to *Annexure E2-1*).
  - (ii) Light to mid colours should be used on all other buildings.
  - (iii) Dark colours should be avoided.
- (k) Awnings
- (i) Awnings are not permitted.
- (l) Parking
- (i) Car parking at ground level is discouraged. If there is no alternative, it should be screened behind habitable uses to a minimum depth of 8 metres.
  - (ii) Car parking must not be visible from the street or from a public place.



**E3 LOCAL VILLAGE CENTRES**

Throughout Waverley there are a number of local village centres. These are smaller centres serving the local community, separate to the regional role of Bondi Junction and Campbell Parade at Bondi Beach.

The centres enjoy unique position and character. Some of these centres are small, but all provide valuable services and facilities to local residents and users.

The purpose of this part is to strike a balance between upgrading and improving the public and private domain in village centres, while maintaining their character and affordability.

The zones reflect a hierarchy, where E1 Local Centre is either a cluster of shops (neighbourhood centre), a larger centre or high-street strip of shops, E2 Commercial Centre is a major centre with office buildings and major retail, while MU1 Mixed Use supports a mix of commercial and residential particularly in strategic centres around a E2 Commercial Centre zone.

CENTRE NAME	CENTRE TYPE
<b>Bronte Road Corridor</b>	
Bronte Road, Bondi Junction	Strategic Centre
Charing Cross	Local Centre
Macpherson Street	Neighbourhood Centre
Bronte Beach	Neighbourhood Centre
Belgrave Street	Neighbourhood Centre
<b>Old South Head Road Corridor</b>	
Flood Street	Neighbourhood Centre
Curlewis Street	Local Centre
OSH Road, at Murriverie Road	Neighbourhood Centre
Rose Bay South	Local Centre
Blake Street	Neighbourhood Centre
Rose Bay North	Local Centre
Murriverie Road	Neighbourhood Centre
Vaucluse	Neighbourhood Centre
<b>Bondi Road Corridor</b>	
Bondi Road	Local Centre
Fletcher Street	Neighbourhood Centre
Bondi Beach	Local Centre

Seven Ways	Neighbourhood Centre
North Bondi	Neighbourhood Centre
Wairoa Avenue	Neighbourhood Centre

**Table 1** Local Village Centres and centre hierarchy

**Note:** Planning controls and objectives for the Bronte RSL site at 113 Macpherson Street, Bronte are in *Part E4 113 Macpherson Street, Bronte* of this DCP.



**Figure 49** Village Centres (Our Liveable Places Centres Strategy)

### 3.1 VILLAGE CENTRE SPECIFIC CONTROLS

This section provides an outline of the 19 [excluding Bondi Beachfront Area and Bondi Junction] identified village centres and detail the desired future character of each centre. The desired future character is to be taken into consideration when designing the built form of the proposed development.

#### 3.1.1 Bronte Road, Bondi Junction

Part E1 Bondi Junction also applies to the Bronte Road village centre.



**Figure 50** Bronte Road Centre

#### Existing Character and Built Form

The Bronte Road centre forms one key entrance route to the Bondi Junction Strategic Centre. It is broken up by existing residential lots and larger lots with little activity. The centre predominantly hosts bulky good retail services and other local businesses and lacks a cohesive character when compared to other centres within the LGA.

The Bronte Road centre has small pockets of consistency towards the north-east end, with local cafes providing the 'hub' for activity towards Bondi Junction. It's location within the LGA is definitely unique, as it sits adjacent to multiple residential streets with large mature trees and other landscape conservation areas, however the centre itself lacks greenery and adequate public domain treatment.

**Desired Future Character Objectives**

- (a) To enable a diversity of businesses, including commercial and urban services, catering to the needs of the broader community.
- (b) To provide places for the arts, entertainment, and culture.
- (c) To support a high level of pedestrian activity and connectivity within and from the centre to Bondi Junction, Queens Park and Charing Cross.
- (d) To promote well-maintained mid-rise buildings of varying styles which form a consistent boulevard of ground floor shop fronts with residential uses on upper floors setback.
- (e) To ensure new buildings provide for a high quality of living with a street frontage that gives comfort to human scale.
- (f) To encourage mid-rise buildings that create a transition between the built form scale of Bondi Junction and Bronte Road in between Ebley Street and Birrell Street.
- (g) To facilitate new housing, commercial opportunities, community facilities and public open space.
- (h) To provide new development on non-heritage sites which maintain a consistent street frontage with adjacent developments, or follow existing street frontages but change materials to promote fine grain-variety of palette, and consider overshadowing to street and back lanes or buildings.

**3.1.2 Charing Cross****Figure 51** Charing Cross Centre**Existing Character and Built Form**

The Charing Cross local village centre is located along a strip of Bronte Road connecting the eastern beaches, Bondi Junction, Centennial Park and the City.

The centre has a diverse range of local shops and services that support the daily needs of local residents and also workers and visitors who frequent the area. The centre has a "high street"

character, supporting the local commercial strip as well a major public transport route to and from the City.

The centre continues to fulfill a valuable social role and meeting place for local residents and for the children attending and travelling to the surrounding schools. The diverse local population also includes aged housing within the centre.

The centre is contained within an existing Heritage Conservation Area, reflecting the high heritage significance of the centre. The area maintains a two (2) storey character, with near-complete rows of highly intact Federation terraces (with continuous lateral pitched roofs) and Victorian terraces (with ornate parapet), interspersed with some examples of two storey Interwar and Art Deco apartments.

These buildings of historic character are all of masonry construction, many with painted plaster render with highly decorative finishes. The buildings are mixed-use and maintain a consistent retail ground floor with residential upper storeys and also support awnings over the entire pavement width.

Narrow passages between terraced groups give access to the rear of properties and laneways. Buildings address Bronte Road and do not address the laneways, although some newer buildings have not maintained this approach to the detriment of the Bronte Road streetscape. Numerous buildings within this area possess elements of, or largely intact, original shop fronts. Many others preserve the original entry configuration (i.e. with inset doorway to one side) reconstructed with contemporary materials.

Important views of historic buildings, available from the public domain, include those of the St Mary's Immaculate Catholic Church and associated buildings (a listed State Heritage group), viewed across the community centre at 280-282 Bronte Road.

Appreciation of the high heritage quality of the building stock of this area is compromised by intrusive suspended power lines and the placement above the line of awnings of other built elements such as advertising structures and air conditioning units.

Buildings are a variety of colours in this area which positively contributes to the character of the area. Where a number of adjoining buildings have been painted the same colour the scale and rhythm of the street has been diminished.

The Eastern Suburbs Legion Club is an important community-based use in the centre, although the building is an intrusive element in the existing Conservation Area.

At present the public domain is not particularly well defined, blurring into the adjacent residential areas, particularly at the northern and southern ends of the high street.

### **Desired Future Character Objectives**

- (a) To limit the scale of redevelopment and infill development at the street edge to match the height of the existing heritage parapet façades and roof lines, with setbacks to further levels where appropriate.
- (b) To ensure that the design of infill development remains consistent with the regular division of frontages, where regular divisions occur.
- (c) To ensure an integrated approach and consistent treatment to the conservation of terrace groups of buildings of historic character.
- (d) To minimise 'visual clutter' through control of peripheral building elements.

- (e) To encourage the conservation of historic architectural details and reconstruction of missing or degraded elements.
- (f) To maintain the continuity of awnings where present.
- (g) To maintain Bronte Road as the primary streetscape in the centre with lanes and side passages as secondary frontages.
- (h) To promote Charing Cross as a destination rather than a thoroughfare, where people visit, stay and enjoy.
- (i) To provide places for the arts, entertainment and culture.
- (j) To increase urban greening where appropriate.
- (k) To promote a high level of pedestrian activity and connectivity within and from the centre to Bondi Junction, Queens Park and Bronte Beach.
- (l) To maintain a prevailing and consistent streetscape, comprising distinctive and well-maintained low-rise Victorian, Federation and Inter-war buildings and shopfronts, reflective of the historical evolution of Waverley's oldest commercial centre.
- (m) To protect the setting of and views to landmark buildings, including the Bell Towers at St Marys Immaculate Church, that are visible across the LGA aided by the centre's ridgeline topography.
- (n) To ensure development is well designed and responsive to existing built form, history and heritage, with appropriate street frontage heights and upper storey setbacks.
- (o) To ensure any new building, or alterations or additions must respect the HCA and its design characteristics without mimicking heritage detailing.
- (p) To ensure that new development should respect the traditional patterns and proportions of the existing development. Additions should be carefully designed to respect the scale, massing and proportions of the existing building and its key design elements and involve the least amount of alterations to significant fabric
- (q) To ensure that no additions are permitted within the front setback of existing buildings unless it can be clearly demonstrated that the new structure will not dominate the streetscape, obscure views to the building or adversely impact the cultural significance of the place.
- (r) Corner development should accentuate the corner and provide a transition from one street to another.
- (s) Larger building façades should be articulated in a regular rhythm to respond to the late 19th Century and early 20<sup>th</sup> century streetscape characteristic of the HCA.



**3.1.3 Macpherson Street****Figure 52** Macpherson Street Centre**Existing Character and Built Form**

The Macpherson Street local village centre provides approximately 60 small commercial premises spread out along the length of the street, stretching from Leichardt Street in the West to St Thomas Street in the East. The range of shops provide for the daily needs of the local community. To the East, near St Thomas Street, the building stock along the ridge-top road is characterised by three (3) storey, mixed-use masonry buildings of diverse styles, both pre-War (c1900) and Interwar. Characteristic buildings have ground floor shops under continuous awnings, residential upper storeys, and some possess intact shop-fronts, or some original elements.

A number of buildings at the west end are higher density residential buildings, while other buildings retain original shop-fronts. Intrusive buildings along Macpherson Street include multi-storey residential and large non-residential buildings. To the West, near Lugar Street, the area is characterised by two (2) storey Interwar commercial buildings of masonry construction, with both decorative face brick and rendered and painted finishes.

Significant views of the ocean exist east along Macpherson Street and to Clovelly looking south from the junction of Macpherson and St Thomas Streets.

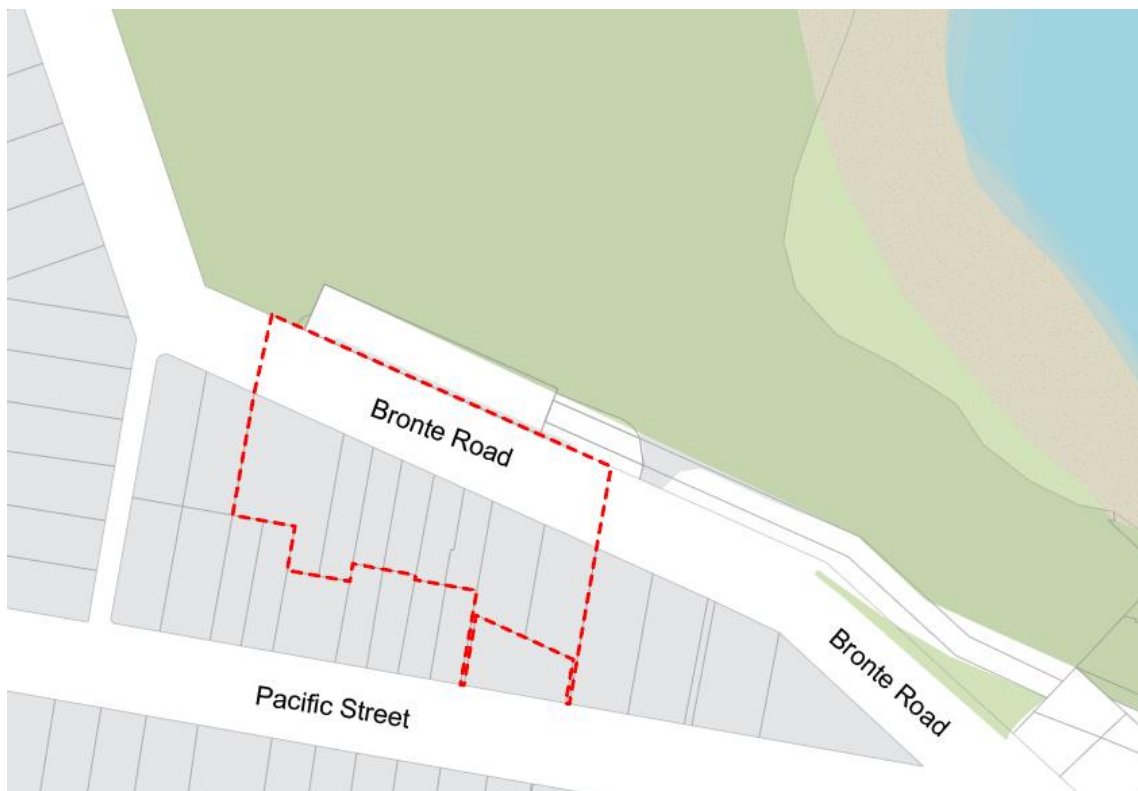
Simpson and Macpherson parks are located at the junctions of Macpherson Street with Firth and Carlton streets. These contribute significantly to the character of the centre, allowing clear southern vistas and valued open space. The existing buildings are of two (2) to three (3) storeys in height.

**Desired Future Character Objectives**

- (a) To maintain the built form arising from the historical subdivision pattern and the small shop character at street level.
- (b) Maintain the public views and outlook at the eastern end of the centre, as well as outlook over open space at the western end of the centre.

- (c) To create and maintain a cohesive and vibrant streetscape, with leafy trees, verge gardens and areas for people to stop and congregate.
- (d) To maintain a physical and visual connection to the coast.
- (e) To maintain low-rise (human-scale) built form of varying styles, with active shopfronts that are open to the public domain.
- (f) To ensure new buildings are of human scale and provide for a high quality of living.
- (g) To maintain fine grain shop-fronts.

### 3.1.4 Bronte Beach



**Figure 53** Bronte Beach Centre

#### Existing Character and Built Form

The Bronte Beach Neighbourhood Centre is typified by a single stretch of two (2) to three (3) storey mixed-use, largely Interwar, buildings with retail frontage at ground level under continuous awnings. Upper storeys (that is, storeys above ground level) are used for residential purposes.

Whilst there are street awnings, those to the western end of the strip are less consistent and successful than those to the eastern end. At the western end both glass and canvas awnings exist which vary from the overall uniform character of the pedestrian experience established at the eastern end.

All buildings of historical character are of brick construction, with painted, rendered, and/or face brick finishes.

Significant views (some partly screened by trees along the bus terminus) of Bronte Beach, Bronte Park and the ocean are possible from all points along this section of Bronte Road.



### Desired Future Character Objectives

- (a) To maintain the existing scale of the small centre.
- (b) To maintain mixed use developments in the centre, with ground floor local shops and services and upper level residential use.
- (c) To maintain, and where possible in the future, enhance, the range of local shops and services to meet the day to day needs of local residents.
- (d) To provide a diversity of businesses and retail offerings, located in smaller uniform shopfronts, that cater to local and visitor needs.
- (e) To retain the low-rise distinctive heritage and character buildings that frame the street, comprising ground floor business and retail offerings, with residential uses on the upper floors.
- (f) To retain the through-site link from Pacific Street to Bronte Road.
- (g) Protect views to Bronte Beach by reduction of visual clutter created by signage, large public domain fixtures and plantings.

#### 3.1.5 Belgrave Street



Figure 54 Belgrave Street Centre

#### Existing Character and Built Form

This centre is made up of a collection of four (4) shops located at the intersection of Belgrave and Murray Streets. This area has a modern, post-war suburban character, with few clear historical elements and varied building typology.

The centre is surrounded by predominantly small lot and medium density residential housing. Though the centre is small, it serves the local residential catchment and passing trade from the Bronte Public School (located towards the south). 45 Belgrave Street is a two storey mixed-use,

red brick corner shop, while 47-49 Belgrave Street are Federation shops and housing. ‘Pocket’ parks exist on opposite corners to these buildings providing a landscape feature to the area. The ‘shop house’ buildings of 47-49 Belgrave Street are of a scale and detail appropriate to the location providing a degree of character to the area.

#### Desired Future Character Objectives

- (a) To maintain the existing scale of the small centre.
- (b) To maintain mixed use developments in the centre, with ground floor local shops and services and upper level residential use.
- (c) To maintain, and where possible in the future, enhance, the range of local shops and services to meet the day to day needs of local residents.
- (d) To promote local business and retail offerings catering to neighbourhood needs.
- (e) To ensure a cohesive and vibrant streetscape, with verge landscaping and a well-maintained community park.
- (f) To encourage upgrades to the facades of existing buildings.

#### 3.1.6 Flood Street

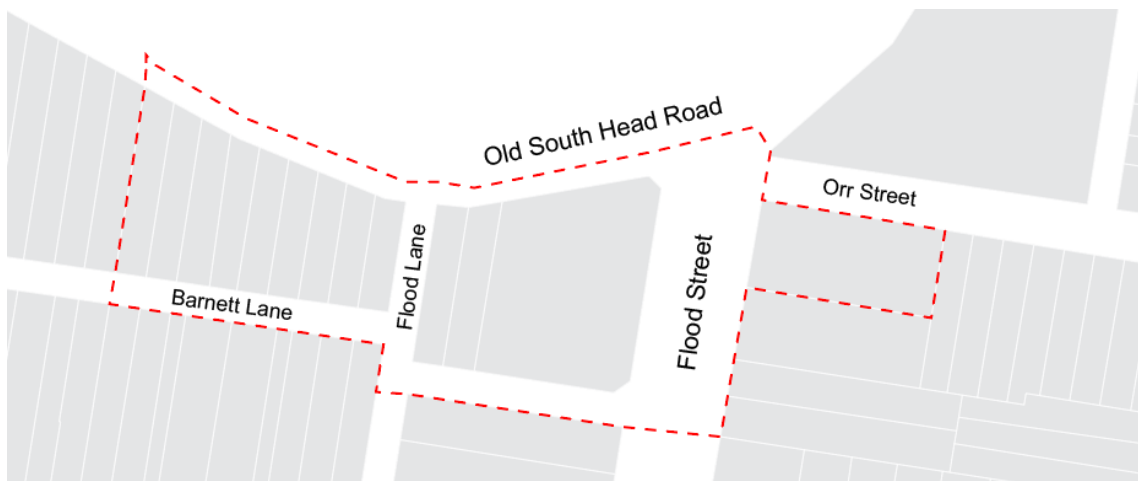


Figure 55 Flood Street Centre

#### Existing Character and Built Form

The buildings in this local centre occupy a bend in the corner of Old South Head Road. They are of mixed architectural fabric. The immediate environment is dominated by traffic and the commercial/retail use of some of the buildings provides a buffer between the road and the residential buildings that sit behind these uses.

The centre has a number of late Victorian, Federation, and Inter-War style dwellings with commercial uses being housed within modern structures.

Height varies between one and three storeys, with buildings located to the front of the property boundaries. Buildings are typically of masonry construction, with residential buildings possessing decorative face and painted brick work.

#### Desired Future Character Objectives

- (a) To maintain the active uses of the centre by way of shops and services at ground level.

- (b) To provide an attractive location for small businesses with exposure to Old South Head Road.
- (c) To provide a safe and walkable public domain.
- (d) To retain low-rise distinctive heritage and character buildings that frame the street, comprising ground floor business and retail offerings, with residential uses on the upper floors.

### 3.1.7 Curlewis Street



Figure 56 Curlewis Street Centre

#### Existing Character and Built Form

This intersection is a prominent marker along the length of Old South Head Road, dominated by traffic and providing little pedestrian amenity.

The buildings are mixed architecturally with no predominant style or built form. The relative importance and scale of the intersection is not reflected in the scale of development.

Buildings are of varied height, yet most contain a retail/commercial ground floor and residential upper storeys, and possess some historic character.

#### Desired Future Character Objectives

- (a) To accommodate a potential increase in the general scale of development in this section of the centre, subject to appropriate site consolidation and satisfying amenity considerations and impacts on adjoining sites.

- (b) To maintain and expand on the current range of land uses, including automotive repairs and service station.
- (c) The site 14-28 Curlewis Street is considered key to the long term objectives of this Part and public domain environment of this precinct. The development of this site to address each of the three (3) street boundaries by building to each property boundary is considered key. The resultant building form will anchor the built form of the intersection while ensuring that each street, Blair and Curlewis streets, is given an improved urban form and scale.
- (d) To create a vibrant streetscape, marking the ‘entrance’ to Bondi Beach and Waverley LGA, with consistent verge landscaping and signage.
- (e) To promote a diversity of businesses, catering to the needs of the local community.
- (f) To promote the provision of important urban services that cater to the needs of the broader community.
- (g) To provide increased urban greening through climate appropriate planting, canopy trees and raingardens.
- (h) To ensure that new buildings and/or refurbishment of existing buildings are well designed and responsive to existing built form.
- (i) To grow and consolidate the commercial area within the centre.
- (j) To maintain special features of character buildings at 1-7, 2 and 9 Curlewis Street.
- (k) To ensure that new building and/or the refurbishment of existing buildings are well designed with quality materials, respecting existing built form and character if historical in nature, whilst accommodating a potential increase in scale (where appropriate).

### 3.1.8 Old South Head Road, at Murriverie Road



**Figure 57** OSH Rd, at Murriverie Road Centre

#### Existing Character and Built Form

This section of the centre provides a break in the residential streetscape and contains a set of retail/commercial shops with residential uses above. The scale is predominantly two storeys.

The area is also dominated by traffic movement and the commercial strip consists of trade shops and outlets, with no local convenience shops.

This section of the centre contains no heritage items, or heritage conservation area listings. With a varied building typology, including some pre-war items, this area does not possess a uniform or identifiable character.

#### Desired Future Character Objectives

- (a) To maintain the predominantly two storey scale, with any additional levels (if appropriate) being set back from the street edge.
- (b) To maintain and remediate original shop fronts as part of any future development.
- (c) To maintain the mixed-use character of the centre by way of shops and services at ground level and residential units above.
- (d) To provide a clean environment, with waste disposal managed efficiently.
- (e) To ensure that the centre provides universal access to all users.
- (f) To promote low-rise well-maintained buildings, comprising ground floor business and retail offerings.
- (g) To ensure that new buildings and/or refurbishment of existing buildings are well designed and responsive to existing low-rise built form, with appropriate setbacks at upper levels.
- (h) To retain and enhance character buildings through the centre including 369A-371 and 377-381 Old South Head Road.

#### 3.1.9 Rose Bay South



Figure 58 Rose Bay South Centre

**Existing Character and Built Form**

The five retail and commercial clusters found along Old South Head Road accommodate approximately 110 shop front premises of which approximately 70 are within Waverley. The two clusters forming the Rose Bay Small Village contain a variety of uses that, when combined with the retail strips on the Woollahra side of the road, provide the daily needs of the local community.

Shop top housing is an important feature of Old South Head Road and provides housing diversity and affordability. This increases pedestrian activity and presence within the village.

**Desired Future Character Objectives**

- (a) To ensure an integrated approach and consistent treatment to the conservation of buildings of historic character.
- (b) To maintain and improve the continuity of awnings over the footpath.
- (c) To maintain Old South Head Road as the primary streetscape in the village with side streets as secondary frontages.
- (d) To create a cohesive streetscape, comprising well-designed low-rise buildings of varying styles which form a consistent street frontage with small active shopfronts.
- (e) To maintain a clean environment, with waste disposal managed discreetly and efficiently.
- (f) To ensure that the centre provides universal access to all users.
- (g) To ensure new buildings are well designed and responsive to existing built form, with appropriate street frontage heights, upper storey setbacks and active ground floor uses.
- (h) To ensure that building services and basement car parking do not compromise the active street frontage and business opportunities that the Old South Head Road high-street offers.

**3.1.10 Blake Street****Figure 59** Blake Street Centre**Existing Character and Built Form**

This local centre has several small shops and commercial uses, servicing the local resident community. The centre does not possess a distinctive historical or neighbourhood character. Modern buildings and renovations having occurred over time creating a varied building typology and street edge definition. While the scale of buildings varies, it is generally two (2) storeys in character. Some buildings in the centre possess street awnings over the footpath.

Due to its elevated location the centre enjoys prominent views west along Blake Street to the inner Harbour and City skyline.

**Desired Future Character Objectives**

- (a) To establish and support a centre characterised by mixed use development incorporating small local shops and services for the local resident community.
- (b) To encourage new mixed-use development with ground level local shops and services and upper level residential use.
- (c) Where redevelopment in the neighbourhood centre occurs, to ensure the scale of new development protects the residential amenity of adjoining and surrounding properties.
- (d) To better maintain the area so that it is clean and attractive, including the replacement of pavers and planting verges that are damaged during construction.
- (e) To ensure that the centre provides universal access to all users.
- (f) To ensure new buildings and/or refurbishment of existing buildings are well designed and responsive to existing low-rise built form.
- (g) To retain the low-rise built form of varying styles, with active shopfronts that contain local business and retail offerings catering to local needs.

- (h) The planting of trees and shrubs as part of a Development Application in this centre should consider the NSW Land and Environment Court Planning Principle based on *Tenacity Consulting v Warringah [2004] NSWLEC 140* which provides general principles for the assessment of views and view sharing. Note: This does not apply to landscape works conducted outside of a Development Application.

### 3.1.11 Rose Bay North



Figure 60 Rose Bay North Centre

#### Existing Character and Built Form

The five retail and commercial clusters found along Old South Head Road accommodate approximately 110 shop front premises of which approximately 70 are within Waverley. The two clusters forming the Rose Bay Small Village contain a variety of uses that, when combined with the retail strips on the Woollahra side of the road, provide the daily needs of the local community.

Shop top housing is an important feature of Old South Head Road and provides housing diversity and affordability. This increases pedestrian activity and presence within the village.

#### Desired Future Character Objectives

- (a) To ensure an integrated approach and consistent treatment to the conservation of buildings of historic character.
- (b) To maintain and improve the continuity of awnings over the footpath.
- (c) To maintain Old South Head Road as the primary streetscape in the village with side streets as secondary frontages.
- (d) Maintain a good distinction between the mixed use sections of Old South Head Rd and residential side streets.



- (e) To maintain a clean and attractive environment, with waste disposal managed discreetly and efficiently.
- (f) To ensure that the centre provides universal access to all users.
- (g) To promote well-maintained mid-rise buildings of varying styles which form a consistent street frontage of ground floor shop fronts and upper storey residential.
- (h) To ensure new buildings are well designed and responsive to existing built form with appropriate street frontage heights.
- (i) To maintain and encourage a diverse range of shops and services.

### 3.1.12 Murriverie Road

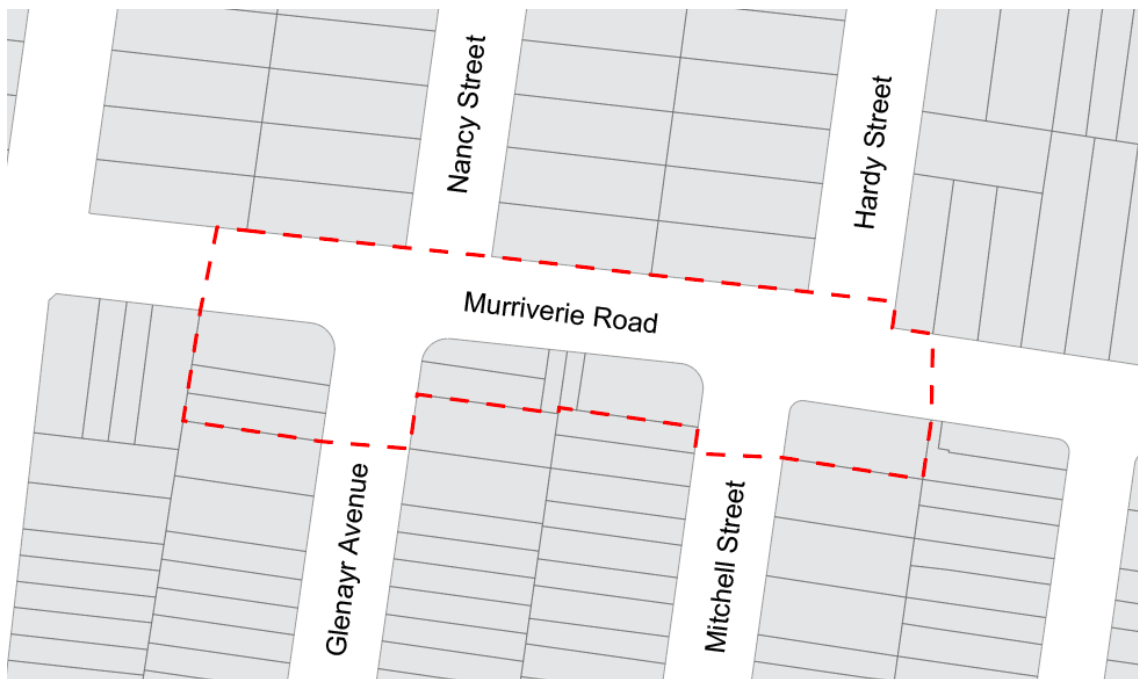


Figure 61 Murriverie Road Centre

#### Existing Character and Built Form

The Murriverie Road local village centre is comprised of approximately nine shops which are used for commercial and retail purposes with some residential uses above ground floor.

The shops are spread over three sections of the street, providing a range of goods and services to assist in meeting the daily needs of the local residents. The area maintains a strong two (2) storey character.

The mixed use buildings are of a range of typologies, built to the street edge with awnings. The buildings of historic character at No.1 Mitchell Street have had some alterations, although the original shop front exists.

The strongest historic character of the centre is provided by the substation, located east of the pocket park on Murriverie Road.

No. 2 Mitchell Street is a good example of a successful transitional building in terms of height (from one (1) to two (2) storeys) and function (from mixed-use to residential).

The centre accommodates a small pocket park at the south east intersection of Murriverie Road and Glenayr Avenue.

#### Desired Future Character Objectives

- (a) To ensure appropriate architectural design and scale for corner site development.
- (b) To maintain and enhance accessibility to public open space.
- (c) To provide a clean environment, with waste disposal managed efficiently.
- (d) To ensure that the centre provides universal access to all users.
- (e) To retain low-rise distinctive heritage and character buildings that frame the street.
- (f) Maintain fine grain shop-fronts and preserve existing character of heritage or character buildings.
- (g) Promote activation of the streetscape.

#### 3.1.13 Vaucluse

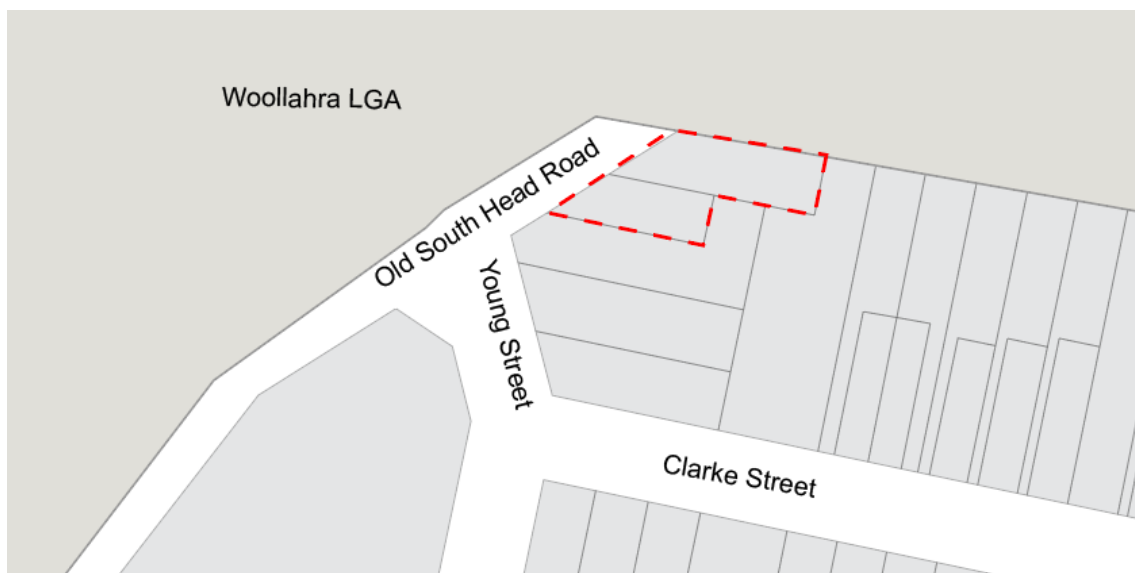


Figure 62 Vaucluse Centre

#### Existing Character and Built Form

The Vaucluse Centre services the northern-most portion of the Waverley LGA. Two lots feature shop top housing development, with ground floor uses activating the immediate surrounds. The vitality of this centre is largely driven by the individual operators of the centre.

The centre often has people seated outdoors, with the close proximity of the centre to public open space attracting good local business.

#### Desired Future Character Objectives

- (a) To promote a safe and attractive meeting point for locals and visitors alike.
- (b) To promote a cohesive and vibrant streetscape, with leafy trees, verge gardens and areas for people to stop and congregate.
- (c) To ensure that the centre provides universal access to all users.
- (d) To retain and maintain the small cluster of shop-top housing.

### 3.1.14 Bondi Road



Figure 63 Bondi Road Centre

#### Existing Character and Built Form

Bondi Road is an important and busy transport corridor that runs along the 'spine' connecting Bondi Beach to Bondi Junction and the City. The existence of numerous bus stops draw people to Bondi Road, increasing pedestrian presence. A strength of the village is good pedestrian accessibility to the retail shops from a relatively large residential catchment.

The strip is composed of smaller 'shop house' buildings of a scale which are reflective of the historical small scale lot subdivision pattern. Buildings are generally two (2) storeys to the street edge, having an effective height, due to the existence of parapets and roof forms, of three (3) levels.

A number of contradictions exist in the form of larger high rise 1960's and 1970's residential and hotel towers. These buildings are inconsistent with the overall scale of the street fabric. Lower podium levels of the building (lower two (2) to three (3) levels) tend to have front and side setbacks inconsistent with adjoining development and the rhythm of the streetscape. All existing buildings of historic character are mixed use, with commercial ground floor and residential upper storey(s).

Numerous buildings within this area possess elements of, or largely intact, original shop-fronts. Many other buildings preserve the original entry configuration (i.e. with inset doorway to one side) reconstructed with contemporary materials.

The Bondi Road centre comprises of three distinct existing characters: West Bondi Road, Central Bondi Road and East Bondi Road. A distinct character exists between the western end and eastern end of Bondi Road, both in built form and the public domain.

The western end of Bondi Road, closer to Bondi Junction, has a less consistent character when compared to the eastern end. The western end has more diverse land use offerings, with a mix of retail, hospitality and personal services. The built form is inconsistent with a former service station, a range of residential and shop-top housing buildings, and public buildings such as St Patrick's Catholic Church and the Waverley Woollahra Arts School.

The northern side of Central Bondi Road section is largely residential development with a few health & beauty services. The southern side is mostly shops, with two residential flat buildings near Boonara Ave. The residential developments along this section of Bondi Rd distinguish this section from the West and East Bondi Rd characters.

The eastern end of the corridor is lively and bustling with activity in the evenings, as a local and tourist 'go-to' for restaurants and recreation. The eastern end of Bondi Road, closer to Bondi Beach, has a mix of commercial and residential ground floor uses. The commercial uses are typically at the street frontage, whilst the blocks of apartments have large front setbacks with vehicle crossings and landscaped areas. There are a number of inter-war period 3-4 storey walk-ups and shop-top housing buildings that provide a strong sense of character to the area. The ground floor commercial uses are mostly hospitality and retail and have created a retail 'hub' around the intersection of Denham Street and Bondi Road, due to the fine grain nature of the shop fronts and human scale of the built form.

### Desired Future Character Objectives

- (a) To maintain the role and character of Bondi Road in providing local shops, services and residential accommodation for the local community.
- (b) To limit the scale of redevelopment and infill development at the street edge to match the parapet façade height of buildings of historic character, with setbacks to further levels where appropriate.
- (c) In the case of future works and improvements to the 1960s and 1970s residential and hotel towers that exist along Bondi Road, to encourage the street and podium levels to better knit the street fabric together through the introduction of shop fronts at ground level.
- (d) To encourage the use of rear courtyards during trading hours to extend business operations where there will be minimal adverse impacts upon surrounding neighbours.
- (e) To support shared cycle/pedestrian links parallel to Bondi Road that will connect Bondi Junction and Bondi Beach, increase pedestrian and cycle safety, provide rear lane activation opportunity and improve service access and on-site parking arrangements.
- (f) To promote Bondi Road as an important local centre that provides a walkable range of goods and services to the surrounding residential community.
- (g) To ensure ground floor premises provide active and inviting street frontages.
- (h) To ensure development incorporates best practice sustainability initiatives.
- (i) To promote localised energy generation including through solar panels and microgrids.
- (j) To promote green roofing and increased planting on buildings where appropriate.
- (k) To promote a clean environment, with waste disposal managed discreetly and efficiently.
- (l) To encourage heat-reflective materials and increased shading to create a cooler climate for pedestrians.
- (m) To ensure that the centre provides universal access to all users.
- (n) To retain the distinctive historic urban fabric of the high street, including the fine grain shopfront pattern, two-storey street frontage and nil-setbacks, and the architectural detail of the original facades.
- (o) To protect and celebrate the historic character and diverse buildings along Bondi Road.
- (p) To ensure infill development is well designed and responsive to the existing built form and scale, including heritage and character buildings, and is of human scale.



Figure 64 Indicative representation of shared cycle/pedestrian links parallel to Bondi Road

3.1.15 Fletcher Street



Figure 65 Fletcher Street Centre

Existing Character and Built Form

The Fletcher Street Centre contributes to the neighbourhood feel of the area. The nearby reserve provides a place to sit and enjoy a coffee in the sun. The centre receives a good amount of foot traffic due to its location on the way to Tamarama Beach.

**Desired Future Character Objectives**

- (a) To ensure that the centre provides universal access to all users.
- (b) To ensure the refurbishment of existing buildings maintains the heritage character of the centre.
- (c) To enhance character buildings through art and planting.

**3.1.16 Bondi Beach****Figure 66** Bondi Beach Centre

Refer to Part E2 of this Chapter for controls relating to the Bondi Beachfront Area.

**Existing Character & Built Form**

The built form is varied with many original buildings remaining as well as newer infill development.

Hall Street and the southern end of Glenayr Avenue contain predominantly mixed use development, with retail shops at ground floor level and residential uses on the upper floors. The retail strip is also adjoined by residential streets along its length, resulting in a vibrant mixed use area. Challenges exist however in terms of managing the interface between the non-residential and residential uses.

Due to the popularity of Bondi Beach and Hall Street, the extent of regional and local traffic and car parking has a strong influence on the character and use of the area, particularly the public domain.

The area contains a consistent pattern of retail buildings located to the front edge of the street boundaries, although some have substantial setbacks from street boundaries. Buildings are typically of masonry construction, with face (decorative) brick and/or painted brick.



In terms of building footprint, regular side passages tend to emphasise separated, regular lots of narrow frontage.

Within the Hall Street precinct are two key sites, namely the Bondi Post Office on the corner of Hall Street and Jacques Avenue, and the intersection of Hall Street, O'Brien Street and Glenayr Avenue.

#### Desired Future Character Objectives

- (a) To maintain Hall Street and the southern end of Glenayr Avenue as a separate and discrete precinct within the wider Bondi Beach town centre, with the role and character of providing local shops, services and residential accommodation for the local community.
- (b) To effectively manage the retail/commercial and residential interface in the centre.
- (c) To maintain and enhance accessibility to public open space.
- (d) To promote a diversity of uses, businesses and retail offerings in smaller shopfronts with active frontages to maximise interactions and interest.
- (e) To consistently maintain the public realm to ensure that it is green, clean and free of litter.
- (f) To increase urban greening around Bondi Beach.
- (g) To promote places for the arts, entertainment and culture as well as health and fitness.
- (h) To ensure ground floor premises provide active and inviting street frontages.
- (i) To ensure development incorporates best practice sustainability initiatives.
- (j) To promote localised energy generation including through solar panels and microgrids.
- (k) To promote a clean environment, with waste disposal managed discreetly and efficiently.
- (l) To protect and promote open spaces and corridors providing visual and physical connection through to Bondi Beach.
- (m) To encourage heat-reflective materials and increased shading to create a cooler climate for pedestrians.
- (n) To balance the shared use of the public domain between pedestrian movements, landscaping, outdoor dining and vehicle access and parking.
- (o) To advocate for improved public transport capacity and services.
- (p) To ensure that the centre provides universal access to all users.
- (q) To ensure infill development is well designed and responsive to existing built form, history and heritage, with appropriate street frontage heights and upper storey setbacks.
- (r) To promote a mix of old and new buildings, with adaptive re-use of heritage and encouragement of innovative modern design for new development.
- (s) To retain the distinctive historic urban fabric including the fine grain shopfront pattern.
- (t) To protect and celebrate the historic character throughout the centre.
- (u) To encourage entertainment or event uses, where residential amenity can be reasonably retained.
- (v) To maintain fine grain shop-fronts in new developments, particularly along Hall Street, Glenayr Avenue and Gould Street.

## 3.1.17 Seven Ways



Figure 67 Seven Ways Centre

**Existing Character and Built Form**

The centre comprises two areas. The first is a small group of buildings located at the corner of Curlewis Street characterised by two (2) storey Interwar mixed-use buildings. The second area is centred around the 'Seven Ways' intersection which is largely comprised of two (2) to three (3) storey Interwar apartment buildings and also notable for its mixed use buildings with ground floor shops and residential storeys above.

In addition to the two distinct centres, Glenayr Avenue includes a series of small scale nodes, interspersed with residential development.

The 'Seven Ways' commercial centre has good quality local shops and cafes. Three of the buildings addressing the 'Seven Ways' and 83-85 Glenayr Avenue possess intact original shop-fronts.

Several mixed-use corner sites were (commercial ground floor and residential upper floors) assessed as being buildings of historic character. They represent examples of successful transition in form and function between the commercial uses of Glenayr Avenue and the residential character of the side streets. These corner buildings enable a transition by a reduction in height, and the incorporation of a setback, in those (northern) facades while addressing the residential side street.



**Desired Future Character Objectives**

- (a) To maintain the role and character of the discrete sections that make up the Glenayr Avenue centre, including the provision of local shops, services and residential accommodation for the local community.
- (b) To effectively manage the retail/commercial and residential interface in the centre, and in particular maintain the strong residential character where it currently exists along Glenayr Avenue.
- (c) To ensure an appropriate architectural design and scale for corner site development.
- (d) The 'Seven Ways' intersection of Blair Street and Glenayr Avenue should stand as the focus of the Glenayr Avenue precinct. This intersection has the potential to be an even more vibrant and active public space.
- (e) To support diverse uses, businesses and retail offerings, interspersed by residential and civic uses and book-ended by open and active community spaces.
- (f) To maintain a fine-grain streetscape with well-maintained and distinctive character buildings.
- (g) Landscaping and tree planting that provides continuous greenery through the centre.
- (h) To promote a clean environment, with waste disposal managed discreetly and efficiently.
- (i) To encourage a high level of pedestrian and cyclist activity and connectivity within and from the centre to surrounding centres and Bondi Beach.
- (j) To ensure that the centre provides universal access to all users.
- (k) A fine-grain streetscape, with well-maintained and distinctive character buildings.

## 3.1.18 North Bondi



Figure 68 North Bondi Centre

**Existing Character and Built Form**

North Bondi Neighbourhood Centre contains a cluster of shops adjacent to the bus terminus. It exists at the northern end of Campbell Parade where it meets Scarborough Crescent, at the intersection with Brighton Boulevard.

The Campbell Parade/Terminus local shopping strip offers a range of retail and other services, providing for the daily needs of the local residents.

This area has a varied building typology, although building styles are all of the Interwar period and built to the street property boundaries. Construction does not exceed three (3) storeys (generally two (2) storeys with a pitched roof) and the majority of buildings of historic character are of brick construction with decorative face brickwork.

All of the buildings of historic character are mixed use, with commercial ground floor and residential upper storeys.

Most buildings in this part of the centre address the terminus/junction area along Campbell Parade and this space is considered to have historic character for the area, given its socially important role as a transport interchange.

### Desired Future Character Objectives

- (a) To maintain North Bondi as a separate and distinct precinct to the larger Bondi Beach precinct, with the role and character of providing local shops, services and residential accommodation for the local community.
- (b) Where redevelopment in the neighbourhood centre occurs, to ensure the scale of new development protects the residential amenity of adjoining and surrounding properties.
- (c) To maintain the predominantly two - three storey scale of development, at the same time as protecting the existing amenity of properties adjoining the centre.
- (d) The North Bondi RSL is an important community building and considered to be a key site in the centre. It is unlikely that this building marked \*, will ever be developed to conform with the planning controls.
- (e) The bus interchange is a key community site and future development at this site is addressed in the Local Village Centres Public Domain Improvement Plan.
- (f) To provide a visual connection to Bondi Beach.
- (g) To provide clean environment, with waste disposal managed efficiently.
- (h) To promote a safe and walkable public domain that promotes connectivity within the centre and to Bondi Beach and surrounding residential areas.
- (i) To ensure that the centre provides universal access to all users.
- (j) To retain low-rise distinctive heritage and character buildings that frame the street, comprising ground floor business and retail offerings, with residential uses on the upper floors.
- (k) To ensure new building and/or refurbishment of existing buildings are well designed and responsive to existing low-rise built form, with appropriate setbacks at upper levels, and driveway crossovers.
- (l) To ensure that no additions are permitted within the front setback of buildings unless it can be clearly demonstrated that the new structure will not dominate the streetscape and subject building, will not obscure views to the building, and will not adversely impact the cultural significance of the place.

**3.1.19 Wairoa Avenue****Figure 69** Wairoa Avenue Centre**Existing Character and Built Form**

The Wairoa Avenue Centre contains fine grain shop fronts with a continuous awning characterising the area. The centre is located in a residential area within walking distance to schools, other larger centres, and Bondi Beach and the coastline.

**Desired Future Character Objectives**

- (a) To promote a small clusters of businesses and retail offerings, interspersed by civic and residential uses.
- (b) To provide a clean environment, with waste disposal managed efficiently.
- (c) To ensure that the centre provides universal access to all users.
- (d) To ensure new buildings are well designed and responsive to the existing built form and scale, including heritage and character buildings, and is of human scale and provides for a high quality of living.
- (e) To ensure low-rise distinctive heritage and character buildings that frame the street.

## 3.2 GENERIC CONTROLS

This section outlines the general planning controls that apply to all centres.

**Note:** Compliance with a control does not guarantee that the objectives are satisfied.

In some instances the design solutions may not be appropriate for the particular site or situation and Council may require an alternative design solution.

In order to ensure the physical characteristics of the site and the nature and proximity of adjoining and nearby development has been considered, a centre analysis is required to be submitted with all development applications which includes the existing built form within the surrounding local village area. Refer to the *Waverley Development Application Guide* for further details.

Annexures are provided to illustrate examples of typical built form envelopes for 2, 3 and 4 storey local village centres as follows:

- *Annexure E3-1* – 2 storeys
- *Annexure E3-2* – 3 storeys
- *Annexure E3-3* – 4 storeys

### 3.2.1 Land Uses

#### Objectives

- (a) To provide for a range of predominately small shops and services to meet the daily needs of the local resident community.
- (b) To ensure the ground floor small shop character of each centre prevails and is protected.
- (c) To limit and manage potentially disruptive uses, such as cafes and restaurants in order that they do not dominate a centre or limit the provision of a broad range of local shops that are needed to meet the needs of the local resident community.
- (d) To promote mixed-use development incorporating high quality residential use above ground level.
- (e) To improve the quality of the built and pedestrian environment, particularly the interface between properties and land uses.

#### Controls

- (a) The ground floor component of a mixed use building is to be used for a permitted non-residential use, with the exception of:
  - (i) Access areas for residential dwellings on upper levels.
  - (ii) Existing purpose built approved and occupied residential dwellings occupying the ground floor of a building.
  - (iii) Where a site addresses a rear lane, the residential dwellings may address the rear lane at ground level but only where all other Local Village Centre planning controls have been satisfied.

- (b) Cafes and restaurants located in corner buildings, with side street frontage to residential streets are to orient the trade area, including any outdoor dining, to the commercial street.
- (c) Seating for cafes and restaurants is to be limited to the enclosed ground floor and, where appropriate, the footpath frontage of buildings.
- (d) Building floors above ground and first floor are to be designed for permanent residential use only.
- (e) Car parking is to be located at basement level with vehicular access from side streets or rear lanes rather than the primary street frontage.
- (f) Vehicle access across the primary street frontage within a Local Village Centre is not supported.
- (g) In cases where no side street or rear lane access is available, development is not required to provide car parking.
- (f) Residential and low scale commercial office uses are acceptable at first floor level.
- (g) Commercial office uses may only take place where the building has been specifically designed, or acceptably adapted, for this use, including adequate separation from residential uses elsewhere in the building.
- (h) Clearly separate and distinguish commercial and residential entries and vertical separation.

---

### 3.2.2 Public Domain Interface

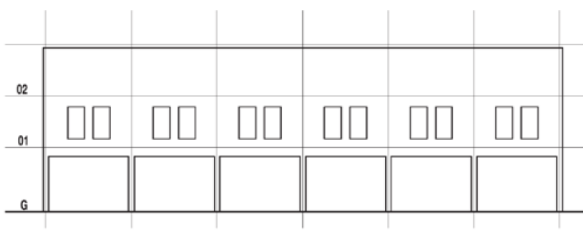
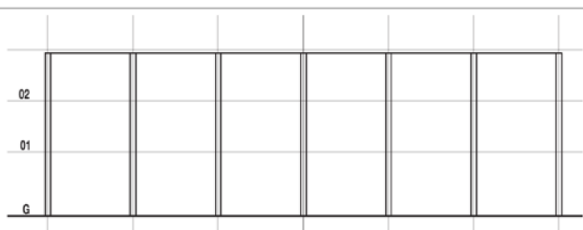
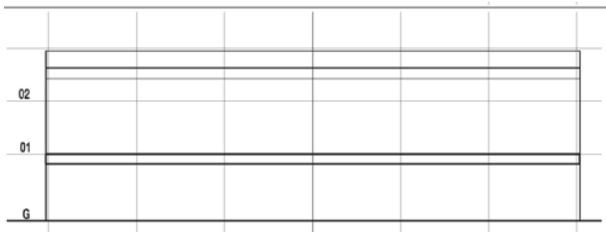
#### Objectives

- (a) To create well defined Local Village Centres, designed for retail trading, appropriate commercial uses and community activity at street level.
- (b) To ensure that ground level frontage is of retail uses to the street edge.
- (c) To ensure interest and vitality by maintaining and encouraging a mix of predominately small scale individual retail outlets.
- (d) To ensure original shop fronts, where they exist, are retained and restored.

#### Controls

- (a) Development must be sensitive to the streetscape character and views. A streetscape and context analysis is to be provided in accordance with *Part B12 Design Excellence*.
- (b) Development on a lot identified in this Part is to provide active street frontages. Refer to *Part B15.2 Active Street Frontages*.
- (c) Buildings are to be located to the front street alignment, with the exception of recommended upper level setbacks, nominated in the controls for each of the individual centres.
- (d) Where existing buildings are setback from the street and are to be refurbished, they are to be extended to the street edge at ground level, except listed heritage items and buildings of historic character.
- (e) Individual buildings are to have a clear street address where entries to upper levels are well defined at the ground floor address.
- (f) New shop fronts are to be consistent in width and height with the predominant and historical character of the street.
- (g) Shop fronts may include recessed entries and display windows, where these are included to provide useable display space and achieve the desired future character of the centre.

- (h) Shop fronts are to be made up predominantly of clear glazing with sill heights to be a maximum of 700mm above finished footpath level along street frontages.
- (i) Access to residential dwellings above ground level should not occupy more than 20% of the principal street frontage of any development.
- (j) There are to be no solid facades along the primary street frontage at ground level.
- (k) Vehicular entries into buildings are not permitted along the primary commercial street frontage of sites, except where contemplated in the planning controls for individual centres.
- (l) The public domain interface of development should provide universal access to all users.
- (m) The design of a development proposal is to have regard to the existing streetscape pattern by applying (i) to (v) below.



(i) Existing streetscapes are to be analysed to understand the existing streetscape pattern. The pattern can be quantified simply by a height to width ratio. New buildings inserted into an existing streetscape should display similar aspect ratios. This ensures the overall pattern and rhythm of the strip is not negatively impacted by new infill development.

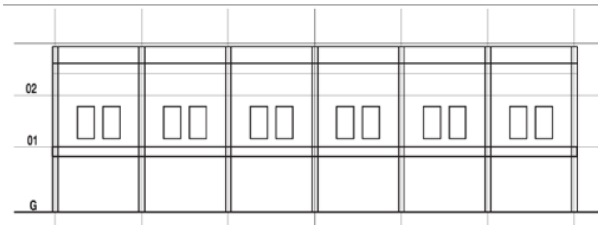
(ii) Horizontal datum points should be established.

(iii) The vertical divisions suggestive of lot subdivision should be referenced even if the development site is larger than the traditional lot sizes.

(iv) Older buildings display a solid to void ratio consistent with a glazed ground level and a more enclosed upper level. The upper levels of these buildings present as a single form with 'punched' openings generally in a masonry background. While a strict



replication of this building form is not necessary any new buildings should display similar characteristics in regards to proportions and ratios.



- (v) The application of (i) to (v) above means that a pattern indicating an understanding of the existing streetscape building form can be quickly established so as to guide the direction of new infill development.

### 3.2.3 Built Form

#### Objectives

- (a) To ensure new and refurbished buildings are of an appropriate scale and design quality, achieving the desired future character of each of the centres.
- (b) To ensure development conserves and enhances buildings and locations of historic character.
- (c) To allow, in some locations identified as appropriate in individual centres, some increase in the height and scale of new development, in order to achieve the desired future character for the individual centre.
- (d) To ensure that buildings provide high quality internal environments for the occupants and users of the buildings.
- (e) In the case of development adjacent to buildings of historic character, to promote a complementary scale and form that enhances the character of the centre.
- (f) In the case of corner buildings, to encourage massing and articulation in order to achieve the desired future character of individual centres.
- (g) To ensure good solar access and amenity to the public domain within the individual centres.
- (h) To support excellence in contemporary design.
- (i) To maintain reasonable solar access to residential properties backing onto rear lanes across from village centres.

#### Controls

- (a) Development is to be consistent with the planning controls relating to overall height, floor to ceiling heights and setbacks, outlined for each of the centres in *Annexures E3-1 to E3-3*.
- (b) Ground floor retail depth must allow for adequate display and sales area as well as essential back-of-house storage and loading facilities. In total this must be a minimum of 8 - 10m in depth.
- (c) The preferred building depth for floors above ground level is 10-14m. The maximum building depth for floors above ground level, glazing line to glazing line is 18m. Refer to the control diagrams for each individual centre.
- (d) Sites in local village centres that adjoin residential development at the rear are to provide deep soil zones within the rear setback area with a minimum depth of 2 metres from the boundary.



- (e) Ensure any alterations or additions are well designed and responsive to existing built form, history and heritage with appropriate street frontage heights and upper storey setbacks.
- (f) The maximum street wall height of buildings fronting rear lanes is 7.8m or two storeys, whichever is the lesser (refer to Figure 56).
- (g) Floors fronting lanes which are located 7.8m above the level of the lane or higher (except those on the south side of the lane) and have residential properties backing onto the rear lane opposite must be setback at an angle of 32 degrees in accordance with Figure 70.

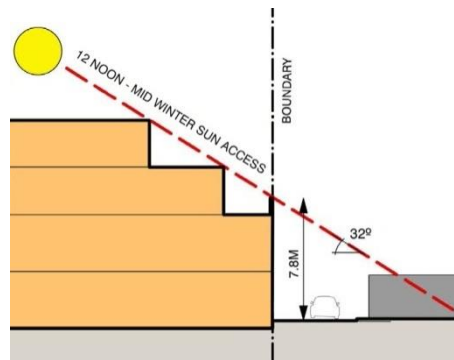


Figure 70 Setbacks at rear lanes to ensure solar access to neighbours

### 3.2.4 Building Façade Articulation

#### Objectives

- (a) To ensure that buildings are designed and detailed to provide a strong street address, enhance the streetscape and achieve the desired future character of the relevant centre.
- (b) To reinforce the prevailing street pattern and rectilinear building forms as well as predominantly vertical proportion of bays, openings and windows.
- (c) To maintain and promote the vertical emphasis of the narrow built forms.
- (d) To actively support excellence in contemporary design, respecting buildings of historic character with contemporary infill development which does not mimic but builds on the principles of the structure of the streetscape pattern.
- (e) To ensure ground level building frontages are active, open and inviting.
- (f) To reinforce the historic street and subdivision pattern and building articulation to ensure that the rhythm of older street patterns is maintained and enhanced.
- (g) To ensure that, where the amalgamation of sites occurs to achieve a singular larger development area, the rhythmic pedestrian street experience is not lost.

#### Controls

- (a) New buildings should display proportions which respect and build upon proportions similar to the adjoining streetscape and building forms.
- (b) New buildings should draw on the predominant pattern of the existing streetscape. They are to be open and glazed at the street level, have an emphasis toward a singular more enclosed building form at the upper levels and be capped by a lighter more articulated element.
- (c) Balconies to the street facade are to be recessed behind the principal building facade.
- (d) Balustrades to balconies fronting the street are to be predominantly solid with minimal or no glass.

- (e) Development directly adjoining buildings of historic character are to be designed so as to respect the hierarchy of the adjoining facade articulation.

### 3.2.5 Buildings of Historic Character

#### Objectives

- (a) To protect and maintain the historical identity of each of the individual local centres.
- (b) To protect individual buildings that are considered to be of historic character in each of the centres.
- (c) To encourage the ongoing and adaptive re-use of buildings of historic character.
- (d) To allow for new development in the individual centres that complements the character and scale of buildings of historic character.

#### Controls

- (a) Identified buildings of historic character, as detailed in the planning controls for each of the individual local centres, are to be retained.
- (b) Where the building form, detailing or use of individual buildings of historic character have been inappropriately altered and changed, any application to upgrade or re-use the buildings must clearly demonstrate that the architectural and streetscape value of the building will be enhanced by the proposal.
- (c) Any application to demolish an identified building of historic character must clearly demonstrate that a replacement building will possess equal or higher quality contributory value with respect to streetscape, character, architectural design, material quality and construction.
- (d) New development adjacent to buildings of historic character must be sympathetic in scale, alignment, detailing and materials.

### 3.2.6 Building Services and Site Facilities

Building services and site facilities for the purposes of this Part relate to:

- Garbage and recycling collection and storage areas;
- Basement storage areas;
- Mail boxes;
- Laundry facilities; and
- Clothes drying areas.

#### Objectives

- (a) To ensure that adequate provision is made for essential building services and facilities on site, integrated into the overall design and planning of the building.
- (b) To ensure that the services and facilities are unobtrusive and do not detrimentally impact on the appearance of the buildings or the view of the buildings from the public domain or adjoining residential properties.
- (c) To ensure that the use and operation of the building services and facilities does not unacceptably impact on the residential amenity of adjoining residential properties.
- (d) To provide a clean environment, with waste disposal managed efficiently.

**Controls**

- (a) Garbage and recycling storage and collection areas, and the structures in which they are contained, are not to be visible from the public domain.
- (b) Setbacks on ground level at the rear are not to be used at all for any purposes associated with storage of waste or recycling material, such as garbage rooms or bottle storage. Buildings are to be designed and used in a manner that ensures that these activities are wholly contained within the building proper. The only exception is for the regular collection of waste and recycling from the rear, in the event of rear lane access. Where a setback at the rear at ground level is provided, it is to be designed and maintained as a landscaped buffer between the subject site and the adjoining properties to the rear.
- (c) The rear of buildings, at ground level, where they back directly on to residential properties or uses, are to be designed to be effectively 'sealed' at the rear, in order that noise and odour transmission from the rear of these premises does not occur in any form that detracts from the amenity of the adjoining residential properties.
- (d) New and refurbished buildings must incorporate venting from ground floor premises in a way that does not result in the transfer of cooking odours impacting on residential properties within the same site/building or neighbouring and adjacent residential properties.
- (e) Air-conditioning units, exhaust fluing, mechanical ventilation ducting, including venting and exhaust structures and equipment associated with ground floor food premises such as cafes and restaurants and the like, are not to be located in front of the front building line or in places clearly visible to the main street frontage or any adjoining or nearby residential properties should be integrated into the building.
- (f) Mixed use buildings are to be provided with sound proof materials between the commercial and residential level.
- (g) Mixed use buildings are to be provided with one only common television antenna and/ or satellite dish, which is to be unobtrusive in appearance when viewed from the public domain.
- (h) Residential units within mixed use developments are to be provided with laundry facilities and at least one external clothes drying area, not visible from the public domain.

## E4 SPECIAL CHARACTER AREAS

Local character is what makes one area distinctive from another. It is the way an area ‘looks’ and ‘feels’. Character is created through the interrelation of distinctive natural and built elements in the public and private domains, including topography, vegetation, streetscape, built form, activity types, as well as the emotional and cultural experience of a place. All areas in the Waverley local government area (LGA) have character, however in some, the character may be more identifiable, more unusual, or more attractive and what is important in one area might be different in another – from vibrant local centres, leafy streets, consistent dwelling typologies and architectural styles to areas and items of heritage significance, and access to coastal views and open space.

Special Character Areas are areas in the Waverley LGA which are considered to have a unique and high character value that warrant more tailored planning objectives and controls to ensure that their character is particularly protected and enhanced. Special Character Areas are selected on cultural, scenic or aesthetic grounds.

### 4.1 BONDI HEIGHTS

Bondi Heights Special Character Area applies to the area bound by Old South Head Road and Francis Street to the north, Wellington Street to the east, Bondi Road to the south and Flood Lane to the west (refer to Figure 1).



Figure 1 Bondi Heights Special Character Area

#### Existing Character Elements

Bondi Heights Special Character Area is located on a local topographical high point. This vantage allows district views to and from the area. It is characterised by north-south oriented streets with well-established street trees. Street blocks are generally long (700-750m) with a range of site lot sizes. A range of building types and styles exist that relate to lot sizes and development history of the area. The overall character of the area is of buildings that multiunit buildings sit in a landscape setting.

#### Desired Future Character Objectives

- (a) To ensure the landscape character is the dominant image of Bondi Heights.

- (b) To maintain the predominant street and rear setback to provide for front gardens and planting of mature trees.
- (c) To ensure buildings respond to their location on the low and high sides of the street with respect to height and site access.
- (d) To ensure front garden walls and fences do not detract from the setting.

### Controls

- (a) Garden walls and fences on the low side of the street are to be a maximum height of 1.2m, to allow front gardens to contribute to the streetscape. Garden retaining walls on the high side of the street are to be a maximum of 1.5m.
- (b) Front setbacks should be predominantly planted or grassed, to allow the elevated view of the front garden to contribute to the streetscape.
- (c) Outdoor terraces and decks are not permitted over garages located on the street boundary on the high side of the street.
- (d) Communal landscaped gardens are required within the front setback to contribute to the public domain.
- (e) The private open space is permitted to encroach 2.5m into the communal landscaped front setback provided that the front setback is a minimum of 6m from the street boundary.
- (f) Roof-top terraces are discouraged due to the greater potential impacts in higher density areas.

## 4.2 NORTH BONDI

North Bondi Special Character Area applies to the area bound by O'Donnell Street, Frederick Street, Murriverie Road to the north, Military Road to the east, Campbell Parade and Warners Avenue to the south, and Glenayr Avenue to the west (refer to Figure 2).



Figure 2 North Bondi Special Character Area

### Existing Character Elements

North Bondi Special Character Area has an undulating topography. The roofscape is prominent when viewed from surrounding high points. There is often a high and low side of the street. Streets generally have wide grassed verges that are sometimes privately planted (through Council's Footpath Gardens Scheme) with vegetation that contributes to the natural headland character. Regular block and lot pattern responds to the changing topographical conditions.

The predominant building stock is characterised by minimum side setbacks, consistent front setbacks and building frontages to the street whether the building type is residential flat buildings or semi-detached dwellings. Roofs are predominantly pitched and red tiled, and are visually dominant on the low side of the street. Much of the area is already developed with very little opportunity for redevelopment on infill sites.

### Desired Future Character Objectives

- (a) To maintain the streetscape rhythm created by uniform building frontages.
- (b) To improve the amenity for residents while not detracting from the amenity of adjacent buildings.
- (c) To allow minor alterations and additions in the roof space.

### Controls

- (a) Communal landscaped gardens are required within the front setback.
- (b) Private open space is permitted to encroach 2.5m into communal landscaped front setback provided the front setback is a minimum of 6m from the street boundary.

## Special Character Areas E4

- (c) The proportion of openings along street facades is to be maintained when retrofitting with balconies.
- (d) Buildings should have pitched roofs with red tiles in keeping with the existing character of the area.
- (e) Attics are to be secondary to the main pitched roof form.
- (f) The established patterns of materiality and colour where there are existing rows of consistency along a street are to be maintained.
- (g) Roof-top terraces are discouraged due to the greater potential impacts in higher density areas.

### 4.3 BEN BUCKLER

Ben Buckler Special Character Area is located on the northern headland at Bondi Beach and applies to the area bound by Campbell Parade and the coastline to the west, Bondi Golf Course to the north, and the coastline to the east and south (refer to Figure 3).



Figure 3 Ben Buckler Special Character Area

#### Existing Character Elements

Ben Buckler exhibits a distinctive palisaded character of parallel streets rising to the outer southern cliff line and lined with Inter War and Mid Century residential flats and housing. Viewed from Bondi Bay, Ben Buckler presents as a dense wall of brick and painted masonry punctuated by glazed openings and a skyline of hipped tile roofs which forms a distinctive and much recognised background to the beach.

Despite the rise of topography to the north and east, streetscapes at Ben Buckler are lined with close set buildings on uniform subdivisions restricting the outlook to glimpses of Bondi Bay, the skyline to the south and the high ground of Bondi Golf course to the north. Only at the extremities of the main streets are vistas of the coastline and beach revealed.

Wide driveways and cross falls to the west, limit the amenity of otherwise wide verges landscaped with turf and sparse coastal tree species. Cranked street alignments to the northern approaches to Campbell Parade, and dense planting within properties to the low side of streets add further to the sense of enclosure.

Within this ground plan the varied styles and forms of construction are unified by orientation of balconies, decks and picture windows southwest over Bondi Bay. The visual complexity of the setting is further emphasized by a distinct separation of public and private space along all streets.

#### Desired Future Character Objectives

- (a) To maintain the headland character of Ben Buckler through the landscaping of the front gardens and appropriate planting of verges.



- (b) To maintain the rhythm of buildings frontages to the street.
- (c) To ensure side setbacks allow glimpses of the beach or ocean.
- (d) To respect the existing building character of boxy proportioned buildings, architectural elements and range of materials and finishes.
- (e) To encourage view sharing.

### Controls

- (a) Planting should utilise minimum maintenance species growing to no more than 1m in height at maturity. The appearance and species selection should be compatible with the adjoining gardens. Growth must not encroach upon the footpath or obstruct pedestrian access.
- (b) Side setbacks are to be clear of obstructions to allow views between buildings to the beach.
- (c) Sites adjacent to laneways and pedestrian connections may be able to achieve increased site coverage with a reduced deep soil requirement. Where deep soil requirements are not met, this area is to be replaced with landscaped open space above ground level.
- (d) Communal landscaped gardens are required within the front setback to contribute to the public domain.
- (e) The private open space is permitted to encroach 2.5m into the communal landscaped front setback provided that the front setback is a minimum of 6m from the street boundary.
- (f) Rendered and painted finish is appropriate in this area.
- (g) Allow balconies to be provided over existing car courts for existing buildings on battle-axed blocks along Ramsgate Avenue.
- (h) Roof-top terraces are discouraged due to the greater potential impacts in higher density areas.

## E5 113 MACPHERSON STREET, BRONTE

Where there are discrepancies between this Part and other Parts of this DCP, the controls in this Part take precedence.

The following objectives and provisions apply to 113 Macpherson Street, Bronte described as Lot 19, Lot 20 and Lot 21 of DP 192094 and Lot 22 of DP 72912, also known as the Bronte RSL site (refer to Figure 57).

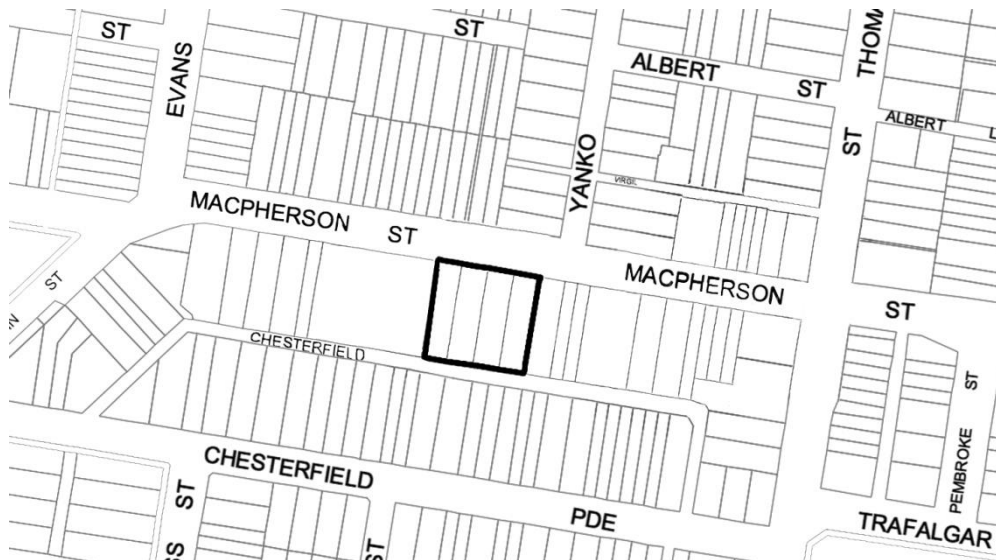


Figure 1 113 Macpherson Street Site Plan

## 5.1 PUBLIC DOMAIN

### Objectives

- (a) Ensure public domain benefits are provided to a high quality and in keeping with Council's vision for the neighbourhood centre.

### Controls

- (a) Macpherson Street and Chesterfield Lane are to be landscaped to Council's requirements.
- (b) Street furniture and renewal of paving is to be provided to Macpherson Street and Chesterfield Lane to Council's requirements.

## 5.2 BUILT FORM

### Objectives





- (a) Facilitate the redevelopment of the site to achieve a high quality urban form.
- (b) To ensure that redevelopment does not result in adverse impacts on the amenity, privacy and solar access of existing and future residential premises within the precinct.
- (c) To facilitate built form that accounts for the change in level between Macpherson Street and Chesterfield Lane.
- (d) To set building heights and frontage alignments to respect the existing character and desired future character of the Bronte's Macpherson Street and St. Thomas Street Neighbourhood Centre.
- (e) Ensure that development has high architectural quality and diversity, and strongly defined streets.
- (f) To ensure that new development reflects the historical subdivision pattern and established rhythm of the main street retail buildings located east of the site.

### Controls

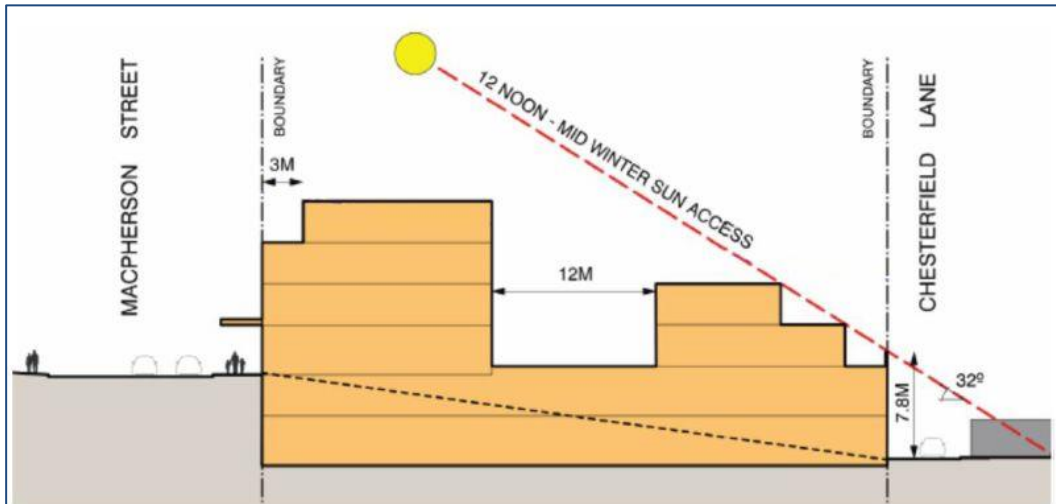
- (a) The development of 113 Macpherson Street is to be in accordance with the development control envelope illustrated in Figures 58 and 59.
- (b) Development is to comply with *Part B16 Public Domain*.
- (c) Provide awnings to the entire Macpherson Street frontage between the ground and first floor, except over the driveway. Refer to *Part B16.4 Awnings and Colonnades*.
- (d) Buildings are to be built to the street and lane alignments.
- (e) No less than 90% of the building is to be aligned to the street boundary for the ground and first floor fronting Macpherson Street.
- (f) Provide setbacks above the street-wall in accordance with Figures 58 and 59.
- (g) Provide side setbacks in accordance with Figures 58 and 59.
- (h) Each retail unit must present to Macpherson Street with a frontage no greater than 6m wide.
- (i) The Macpherson Street facade must be articulated to reflect the established 6m / 12m rhythm of the existing main street retail buildings located east of the site.



**Legend**

-  PROPOSED BUILDING ENVELOPE
-  EXISTING BUILDINGS
- 4** HEIGHT OF BUILDINGS (IN STOREYS)
- 6** DIMENSIONS (IN METRES)
-  NON RESIDENTIAL VEHICULAR AND LOADING ACCESS
-  RESIDENTIAL VEHICULAR ACCESS

**Figure 58** Development Control Envelope



**Figure 1** Development Control Envelope section

### 5.3 ACTIVE STREET FRONTAGES

#### Objectives

- (a) To promote pedestrian activity and safety in the public domain.
- (b) To provide a high degree of surveillance over Macpherson Street and Chesterfield Lane
- (c) To provide transparency and visual contact between the public domain and the building interior.
- (d) To ensure that retail premises present a “public face” to enhance the character and vitality of the neighbourhood centre.

#### Controls

- (a) Active street frontages are required at footpath level along Macpherson Street.
- (b) Not more than 10% of the Macpherson Street frontage can be blank walls or service areas.
- (c) Uses providing passive surveillance of Chesterfield Lane must be provided for the majority of the width of the ground and first storey fronting Chesterfield Lane. Car parking must be sleeved by a commercial or residential use.

## 5.4 TRANSPORT

### 5.4.1 Loading Facilities

#### Objectives

- (a) To ensure that non-residential uses do not result in adverse impacts on the amenity of existing and future residential premises, schools, childcare centres and community facilities.

#### Controls

- (a) Driveway entry and exit to commercial loading docks is restricted to Macpherson Street.
- (b) The driveway access to loading facilities and parking must be combined.
- (c) Loading facilities must be located internally on the site. They must not front Macpherson Street.

### 5.4.2 Driveways and Car Parking Access

#### Objectives

- (a) To ensure that non-residential uses do not result in adverse impacts on the amenity of existing and future residential premises, schools, childcare centres and community facilities.
- (b) To ensure main streets are not dominated by driveways.
- (c) To encourage continuous main streets.
- (d) To ensure safety for pedestrians on heavily used footpaths.

#### Controls

- (a) The width of the driveway on Macpherson Street must be no greater than 9m wide.
- (b) The driveway off Macpherson Street must be located at the western end of the front boundary as shown on the development control envelope (refer to Figure 58).
- (c) Access to residential parking is permitted from Chesterfield Lane.
- (d) Access to commercial, retail and RSL club parking is not permitted from Chesterfield Lane.
- (e) Provide a maximum gradient of 1 in 20 (5%) for the car park access driveway for the first six metres within the site.
- (f) The driveway access must be fully enclosed where located more than six metres from the Macpherson Street site boundary in order to provide acoustic attenuation for the residential apartments to the west of the site.

---

**5.4.3 Non – Residential Parking Rates**

**Objectives**

- (a) To provide dedicated car parking for those working at the development.

**Controls**

- (a) Of the total number of non – residential parking spaces provided, 80% is to be allocated for visitors / short-stay parking, and 20% is to be allocated for employee / long-stay parking.

---

**5.4.4 Bicycle Parking**

**Objectives**

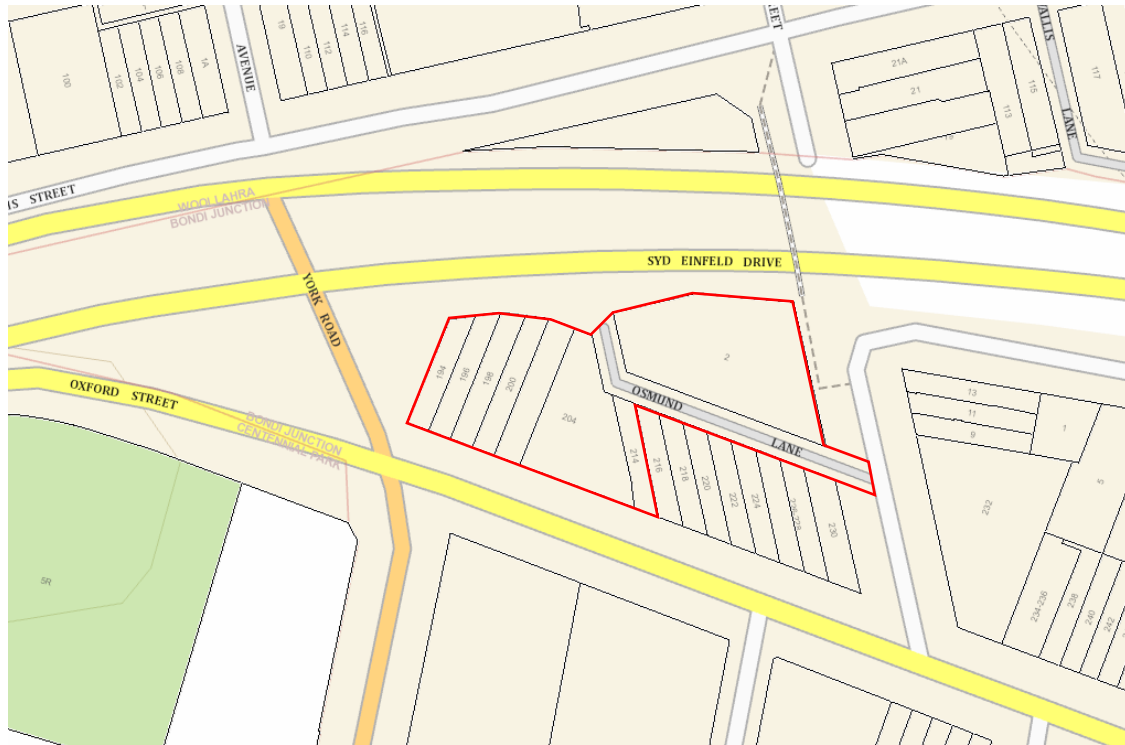
- (a) To provide accessible secure and safe bicycle parking close to major pedestrian entries.

**Controls**

- (a) Provide minimum 50% of the required bicycle parking for non-residential premises at an accessible on grade location near the main pedestrian Macpherson Street entries.

**E6 194-214 OXFORD STREET, 2 NELSON STREET AND OSMUND LANE, BONDI JUNCTION**

The following objectives and controls apply to 194-214 Oxford Street, 2 Nelson Street and Osmund Lane, Bondi Junction described as Lots 10, 11, 12 and 13 DP 260116, Lot 16 DP 68010, Lot 1 DP 79947, Lot 1 DP 708295 and SP 34942 (refer to Figure 60).



**Figure 1** Subject sites outlined in red

Where there are discrepancies between the controls of the DCP and others within this site specific DCP, these controls take precedence.

The intention of this site-specific DCP is to encourage and facilitate innovative design that reflects the landmark significance of this site. The controls in this Part of the DCP are not intended to be prescriptive if it can be demonstrated that the design has achieved the objectives of this Part through minor discrepancies from this Part. This Part of the DCP has been created with regard to the following Planning Principles for the site:

- An acceptable human scale at the podium height
- Slender towers to mitigate visual amenity impacts
- Good public amenity on the site
- Significant landscaping on site including deep soil planting and substantial mature tree planting



**6.1 BUILT FORM****Objectives**

- (a) To deliver the highest standard of architectural, urban and landscape design.
- (b) To establish building envelopes that minimise overshadowing on Centennial Park and surrounding low scale residential areas.
- (c) To ensure buildings are environmentally innovative particularly with regard to water and energy conservation.
- (d) To ensure development does not adversely impact on the significance of the neighbouring heritage buildings, landscape and conservation areas.

**Controls**

- (a) A two/three storey podium is to be provided fronting Oxford Street.
- (b) Architectural form is to be articulated to address the corner of Oxford Street, York Road and Syd Einfeld Drive.
- (c) The articulation of the podium level is to reflect a fine grain, terrace-like subdivision pattern consistent with the existing terrace subdivision pattern along West Oxford Street.
- (d) The towers are to be set back six metres from the edge of the podium fronting Oxford Street. A lesser setback may be considered if it can be demonstrated that it achieves the objectives of this DCP.
- (e) The tower location must minimise overshadowing of Centennial Park and the surrounding low scale residential areas.
- (f) No additional height or floorspace ratio above the LEP controls will be considered for these sites.
- (g) Floor space in podium levels must be used for commercial and retail uses. Any storage space, servicing areas, car parking or other areas that are not defined as calculable floor space under Waverley LEP must be located below ground.

**6.2 DESIGN EXCELLENCE****Objectives**

- (a) To deliver the highest standard of architectural, urban and landscape design.
- (b) To maximise the overall environmental performance of new buildings.

**Controls**

- (a) The tower location must minimise overshadowing of Centennial Park and the surrounding low scale residential areas.
- (b) The development must minimise any impacts on heritage items in the vicinity of the site.
- (c) The development must minimise any visual impact of the buildings when viewed from Centennial Park and the Public Domain.
- (d) The development must incorporate Ecologically Sustainable Development Principles to minimise carbon emissions, potable water use, energy use and waste.
- (e) The internal planning and façade design of the buildings are to address and ameliorate the significant road noise.
- (f) All materials must be naturally finished, low maintenance, contextually appropriate and painted surfaces are discouraged. Materials used shall be durable and weather well over time.
- (g) Air conditioners are not to be located on balconies.

### 6.3 PUBLIC DOMAIN

#### Objectives

- (a) To provide a high quality and safe public domain with high pedestrian amenity that benefits the wider community.
- (b) To facilitate pedestrian movement and priority throughout the entire site.
- (c) To ensure the highest standard of architectural, urban and landscape design.
- (d) To provide public art in prominent and publicly accessible locations.
- (e) To facilitate substantial planting to mitigate any visual impacts the towers may have from Centennial Park and surrounding areas.

#### Controls

- (a) As agreed in the Voluntary Planning Agreement, a public plaza totaling a minimum of 311m<sup>2</sup>, a pedestrian/cycleway through site link from Oxford Street to Osmund Lane totaling 136m<sup>2</sup> and approximately 208m<sup>2</sup> of footpath widening is to be provided.
- (b) The public plaza must receive 3 hours solar access to a minimum of 50% of its area on 21 June.
- (c) The area within the drip line of the heritage listed Norfolk Island pine tree must incorporate permeable materials.
- (d) A through-site link is to be provided between Oxford Street and Osmund Lane uncovered by any structure (except for the building awning) and must be publicly accessible between the hours of 7am-10pm Monday to Sunday.
- (e) Active frontages are to be provided to all public places at street level.
- (f) Street furniture and public art is to be provided within any public plaza in accordance with Council's Public Domain Improvement Plan and Public Domain Technical Manual.
- (g) Awnings and footpaths are to be provided on all active frontages.
- (h) The 3.5m of land dedicated along Oxford Street will be used for mature street tree plantings and landscaping purposes.
- (i) Stormwater drainage locations and landscaping are to be detailed in any plans submitted as part of a design excellence competition.
- (j) Under awning lighting is to be provided to achieve appropriate luminance levels for pedestrians (refer to relevant Australian Standards). Lighting should be recessed into the soffit of the awning.
- (k) Landscaping and design of the public domain is to be high quality and incorporate features such as indigenous tree species and landmark sculptural elements.
- (l) A Landscape Plan for the proposed public plaza and public realm surrounding the development is required to be submitted in accordance with the *Waverley Development Application Guide* and include:
  - i. Substantial planting of mature trees fronting Oxford Street, Syd Einfeld Drive and York Road; and
  - ii. A schedule of the common name and scientific name of species to be planted, the size and number; and
  - iii. A plan showing the location of the plants in the schedule and all deep soil planting.
- (m) An independent arborist report must be submitted to Council prior to the commencement of any design excellence competition. The report will detail all

existing trees on and adjacent to the site and outline all trees that can be retained based on AS 4970 – Protection of trees on development sites.

- (n) A communal rooftop space landscaped with drought tolerant Australian native plants must be provided for resident access and use on both towers.
- (o) Podiums are to be landscaped with drought tolerant Australian native plants.
- (p) A Public Art Plan is to be prepared and submitted that outlines public art for the proposed public plaza and public realm surrounding the development.
- (q) The ongoing management of any public domain or plazetta provided is to be the responsibility of the body corporate.
- (r) Any land dedicated for public use must only be used for public use and cannot be used for vehicle access, garbage truck access or space required for the operation or maintenance of the towers.

## 6.4 WASTE

### Objectives

- (a) To ensure new developments and changes to existing developments are designed to minimise waste generation and maximise resource recovery.
- (b) To encourage waste storage facilities that are designed to enable source separation for recovery.
- (c) To ensure waste and recycling systems are easy to use and complement Council's waste and recycling services.
- (d) To promote safe practices for storage, handling and collection of waste and recycling.
- (e) To prevent stormwater pollution that may result from poor waste and recycling storage and management practices.
- (f) To minimise amenity impacts during the storage, use and collection of waste and recyclables.
- (g) To prevent impacts to the environment that may result from litter, excess waste and illegal dumping.
- (h) To minimise interference of waste collection on pedestrian access, safety and amenity.
- (i) To minimise interference of waste collection on local traffic.

### Controls

---

#### 6.4.1 General

- (a) The Site Waste & Recycling Management Plan (SWRMP) is to be submitted in accordance with the Waverley Development Application Guide.
- (b) Waste storage space is to be designed with flexibility to accommodate a future change in use to a use with a higher waste generation rate.

---

#### 6.4.2 Amenity

- (a) Waste and recycling storage areas must be visually and physically integrated into the design of the space.
- (b) Waste and recycling storage areas must be designed and located to avoid adverse impacts on the amenity of adjoining sites including noise, odour and visual impacts.
- (c) All public place waste and recycling receptacles must align with council's Public Domain Technical Manual.

---

#### 6.4.3 Access and Collection

- (a) On-site waste collection is to be accommodated within a basement or at grade within the buildings from a dedicated collection point or loading bay that does not impede pedestrian or vehicle movement within the development.
- (b) The on-site waste collection point is to be of a sufficient size to store all bins to be collected without interruption to the functioning of the development.

---

**6.4.4 Ongoing management**

- (a) Ongoing management of the area is to be in accordance with the approved site waste and recycling management plan (SWRMP) of each development in the area to ensure that appropriate waste and recycling services are provided.
- (b) The SWRMP must be re-evaluated every 5 years and amended with relevant information.
- (c) Waste generated by a development must not exceed the maximum permitted generation rates for each building's use.

## 6.5 ACCESS AND PARKING

### Objectives

- a) To minimise the impacts of vehicles on pedestrian amenity and public spaces.
- b) To encourage a safe and practical space for all transport modes.
- c) To minimise any additional pressure on the existing parking in West Bondi Junction.

### Controls

- a) Osmund Lane is to be retained as a 7.0 metre local access lane with “No Parking” restrictions on both sides.
- b) Access to and from Osmund Lane at Nelson Street is to be left-in left-out with enforcement by signs or a central raised median on Newland Street.
- c) The pedestrian bridge over Syd Einfeld Drive and ramps/stairs is to be retained. The bridge should be easily accessible from the site and the pedestrian and cycleway through site links.
- d) Resident parking should be provided on site
- e) The 3.5m road widening dedication along Oxford Street is not required for traffic related uses and as such can be allocated for other purposes.
- f) Resident parking for this development will not be included within area 22 of the Waverley Resident Planning Parking Scheme (RPPS).

6.6 PEDESTRIAN AND CYCLEWAY CONNECTIONS

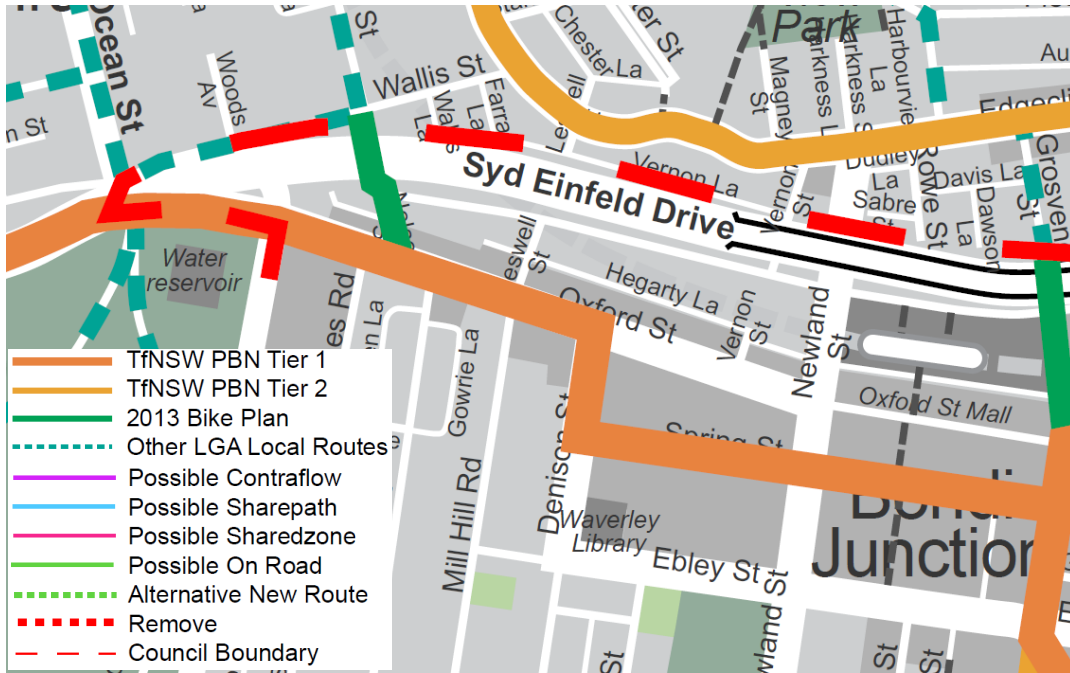


Figure 2 Cycleway connection route\*

\*Note: The Waverley 2013 Bike Plan designates the cycleway on this site for mixed traffic.

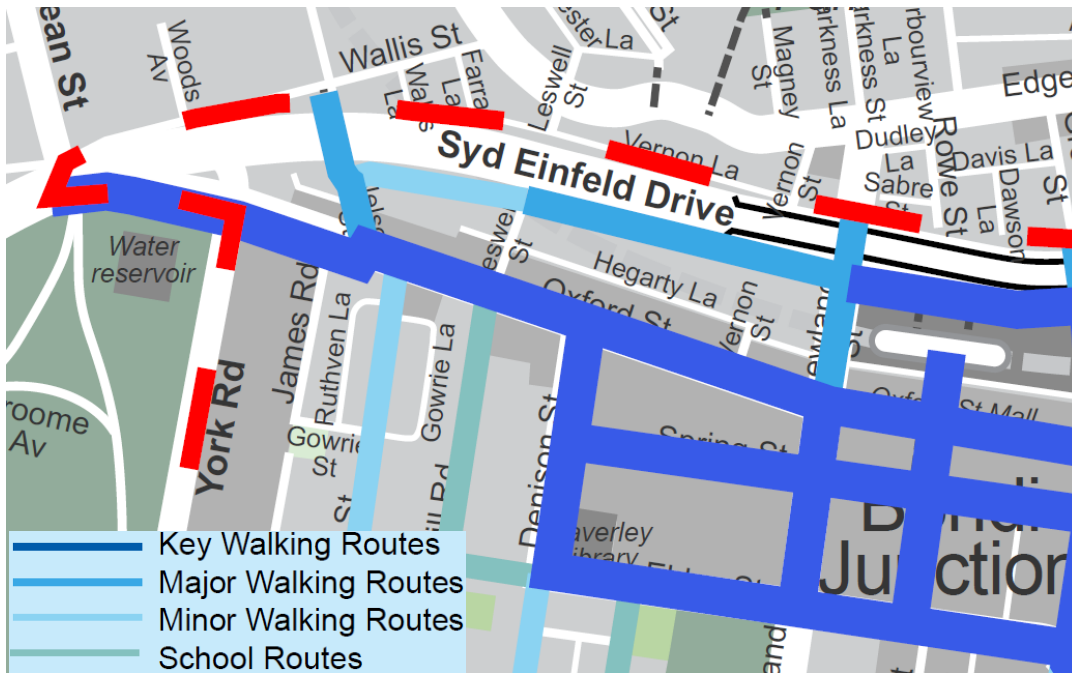


Figure 3 Pedestrian connection route



**E7 EDINA ESTATE**

Where there are discrepancies between this Part and other Parts of this DCP, the controls in this Part take precedence.

The following objectives and provisions apply to the site known as the Edina Estate, identified in Figure 1. For clarity, the Edina Estate is the entirety of the urban block bound by Birrell Street, Carrington Road, Church Street, and Bronte Road, Waverley.



**Figure 1** Edina Estate

## 7.1 GENERAL

The vision for the site is to maintain and grow a health and seniors housing precinct that celebrates the outstanding heritage significance of the site and supports healthy living. This precinct will support, renew and expand community services and residential living within Waverley, which is at the heart of the vision for the site.

### Objectives

- (a) To conserve and interpret the significant European heritage of the site.
- (b) To understand and interpret the Aboriginal cultural heritage of the site.
- (c) To ensure the precinct can adapt to the projected localised impacts of climate change.
- (d) To ensure the developed precinct is designed to facilitate healthy and active living and encourage social connectivity within the precinct and within the community.
- (e) To ensure that invited publicly accessible high-quality open spaces are provided that interpret, reinstate or conserve the heritage features of the Edina Estate.
- (f) To minimise vehicle movements within and to the site, and to manage service vehicle movements effectively.
- (g) To provide for clear wayfinding and integrated public artworks that interpret the heritage significance of the site.
- (h) To allow for the continuation, renewal and expansion of community services and residential living.
- (i) To acknowledge and respond to the urban context in terms of form and scale.

### Principles

This Site Specific DCP has been developed based on the following principles, which are to be addressed in any masterplan or development on the site:

1. Unify the Estate and enhance its ongoing legacy of care as a community service and health care precinct.
2. Develop a clear masterplan based on the historic evolution of site, its evolving context and community requirements.
3. Retain and restore existing heritage fabric, enhance public access to the heritage garden and reinterpret the former carriageway to heritage gates.
4. Allow for the continuity and expansion of existing hospital uses on the site.
5. Establish a new centrally located residential aged care and community hub as an active “heart” for residents, patients and the broader community.
6. Provide new seniors living; optimise direct street address, residential amenity, streetscape character and landscape.
7. Consolidate new built form to create large continuous gardens for a range of public, private and community uses.
8. Optimise site ecology by maximising deep soil zones and implementing a long-term tree plan (ie. a plan to retain and protect existing healthy trees, replace old or damaged trees and increase the number of large trees on the site).
9. Implement a clear vehicular strategy to prioritise pedestrian comfort and safety while recognising the operational needs and diversity of uses of the estate.
10. Achieve all required operational requirements while achieving compliance with

- all urban design, environmental and amenity design standards.
11. Provide architectural modulation and articulation that reflects the cadastre and built form of the adjacent heritage conservation areas.

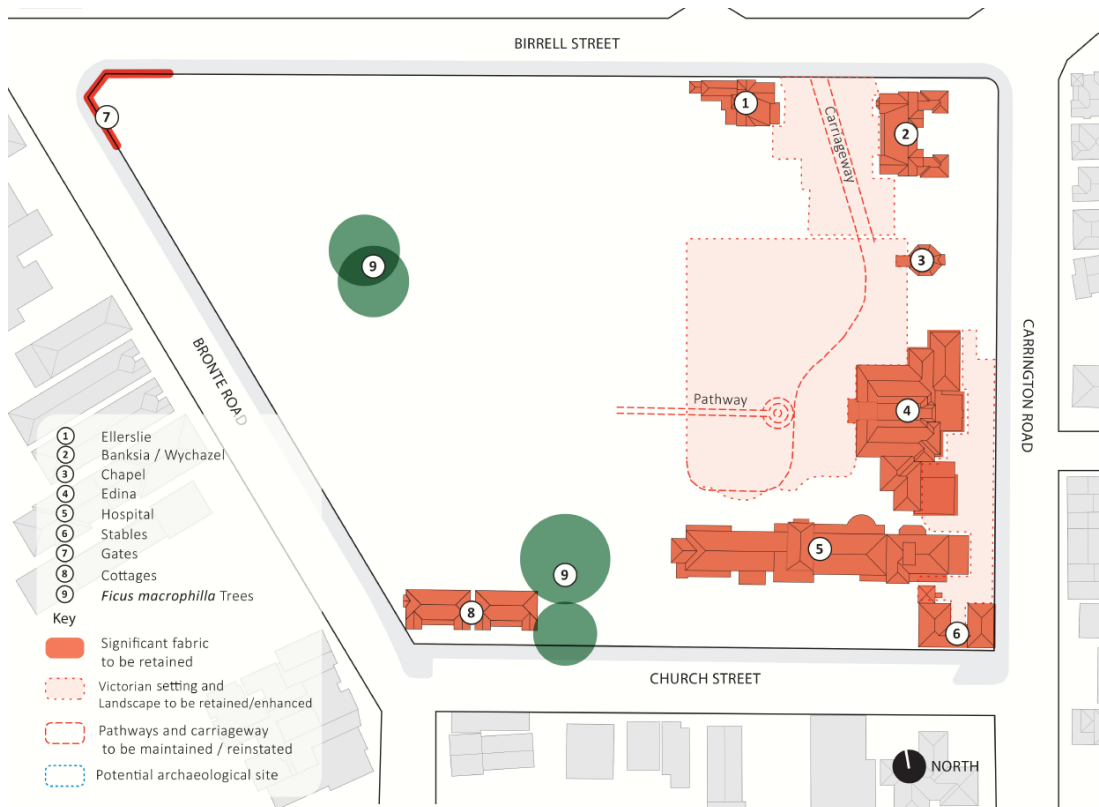
## 7.2 SITE LAYOUT

### Objectives

- To provide invited public access to and enjoyment of the setting of the heritage buildings and their heritage landscape.
- To identify developable portions of the site.
- To reinstate the experience for the public of exceptional Victorian buildings set in a Victorian-style landscape for its users.

### Controls

- The site layout is to interpret the original arrival experience via the historic pathway from the gates at Bronte Road and Birrell Street as a key entrance point to the site predominately for residents.
- Maintain the buildings identified in Figure 2 as Significant.
- There is to be a series of open spaces and layouts within the site.
- The eastern portion of the site is to be retained as an invited, publicly accessible area as identified in Figure 4 and a public access pathway is also to be provided from the north-west of the site via the heritage gates as identified in Figures 4 and 5.
- The scale of new buildings must not challenge or overwhelm the heritage buildings, Victorian streetscape, or landscape.
- Where possible, provide vistas throughout the site to the western façade of the Vickery (Edina) Building and tower.



**Figure 2** Site Plan identifying significant fabric and spaces to be retained

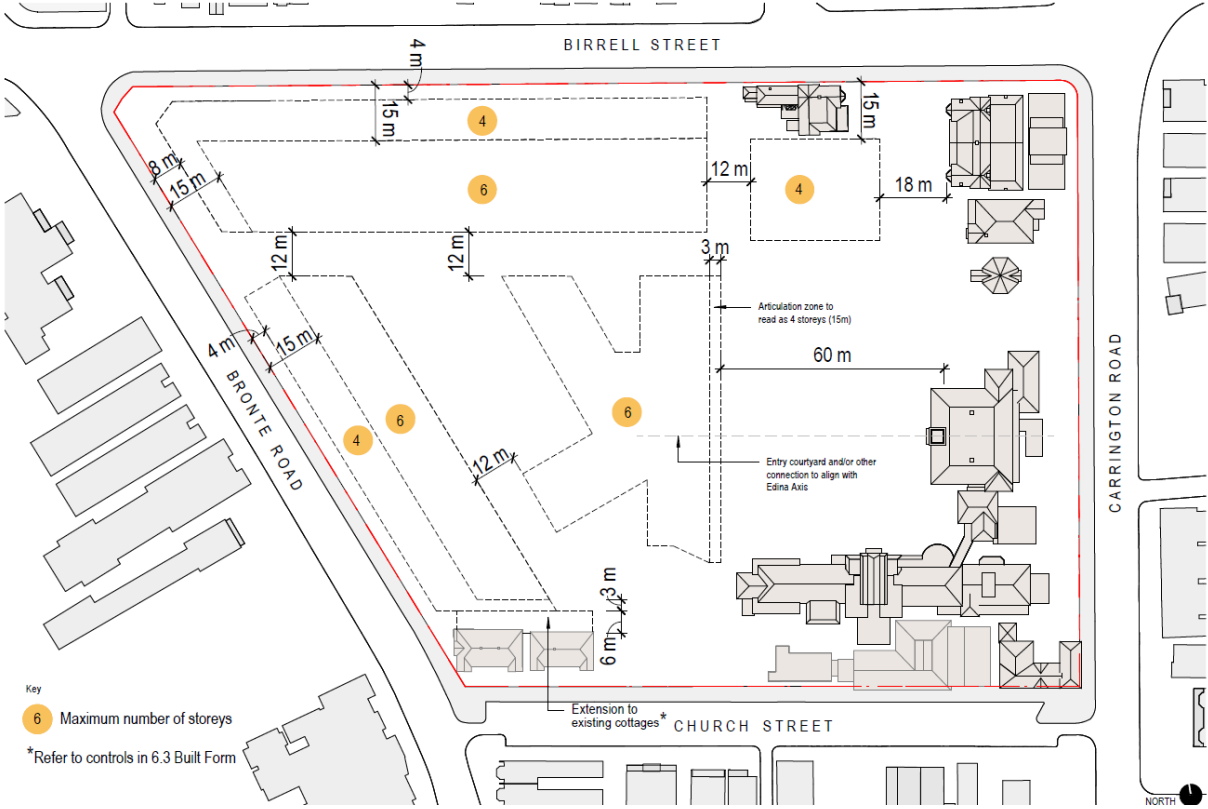


Figure 3 Site Layout and New Building Zones

### 7.3 BUILT FORM

#### Objectives

- (a) To ensure an appropriate scale of new development on the site.
- (b) To provide guidance for the location of buildings.
- (c) To ensure new development responds to the heritage characteristics of the site.
- (d) To generate a campus-style arrangement of development.
- (e) To support sufficient landscaping to enhance visual quality, streetscape character and provide privacy.
- (f) To integrate building form with the sloping topography of site.

#### Controls

- (a) The location of buildings is to comply with the Principles in 7.1 General and the layout shown in Figure 3.
- (b) The number of storeys is to comply with Figure 3. However, due to the sloping nature of the site, it may be possible to achieve a greater number of storeys than the maximum number of storeys specified in Figure 3 to enable optimised building layout, so long as the built form does not exceed the alternative height of buildings of 15m and 21m specified in the WLEP unless in line with control (k) and not in contradiction with (e).
- (c) The redevelopment of the site is to read as a campus-style development, having consistent style and architectural qualities across the site.
- (d) Despite the alternative building height of 15m and 21m permitted in the WLEP, the following controls apply to any building located adjacent to the Ellerslie building:
  - i. Any storey above the upper gutter line of the principal-built form of the Ellerslie building is to provide a contemporary and complementary design response so as to avoid any adjacent building overbearing its heritage setting.
  - ii. Is not to overwhelm the Ellerslie building, and is to provide sufficient distance between the buildings to maintain the curtilage of the Ellerslie building.
- (e) Despite the alternative building height permitted in the WLEP, any new built form extension to the cottages on the corner of Bronte Road and Church Street:
  - i. is not to overwhelm the cottages, and
  - ii. if connected to any new building fronting Bronte Road is to have a maximum of one storey, with a maximum height that is beneath the underside of the gutter line of the cottages or;
  - iii. if not connected to any new building fronting Bronte Road, a maximum of two storeys.
- (f) New buildings fronting Bronte Road and Birrell Street are to be modulated and articulated to break up long facades to the streetscape.
- (g) Buildings are to be setback from the street frontage to provide privacy and opportunities for landscaping, including where appropriate, mature tree planting.
- (h) New buildings are to provide appropriate architectural modulation and

articulation that reflects the cadastre and built form of the adjacent heritage conservation areas.

- (i) Any new building to the corner of Bronte Road and Birrell Street is to provide a bulk and scale that relates to the development on the remaining corners of the intersection.
- (j) Any new building to the corner of Bronte Road and Birrell Street is to be designed in a way that respects and does not overwhelm the heritage gates on the corner of Bronte Road and Birrell Street.
- (k) Due to the sloping nature of the site, it may be necessary to exceed the alternative building heights specified in the WLEP, for minimal areas of a roof envelope to enable optimised building layout.
- (l) No habitable room is to be more than 1.2m underground at finished floor level.

## 7.4 HERITAGE

The curtilage of the Edina Estate is bounded by Bronte Road, Birrell Street, Church Street, and Carrington Road.

### Objectives

- (a) To conserve and interpret the cultural significance of the site.
- (b) To provide invited public access to and enjoyment of the setting of the heritage buildings and their heritage landscape.
- (c) To celebrate the heritage significance of the site by interpreting, retaining and conserving key historical features of the site.
- (d) To share the history of the site through informative, accessible and well-designed interpretation, artworks and wayfinding.
- (e) To reinstate the experience for the site users of exceptional Victorian buildings set in a Victorian-style landscape.

### Controls

- (a) A Conservation Management Plan is to be provided for the site that responds to the Statement of Significance of the heritage item.
- (b) The existing hospital use is a historic use that should be continued, and should be broadly defined to include uses related to health, aged care, and health related training.
- (c) The following historic spatial uses relating to the Victorian period are to continue or be re-instated / interpreted:
- (d) early entrances and driveway as identified in Figure 2;
- (e) Victorian garden areas as garden/passive recreation as identified in Figure 2.

#### 7.4.1 Significant Fabric, Views, Spaces and Spatial Relationships

- (a) The significant fabric and spatial relationships as identified in Figure 2 are to be conserved and enhanced. They are:
  - i. Victorian buildings and estate planning, including: topography, plantings, fences, statuary and spatial order (including the private street, and distinction of service areas such as original stable and kitchen buildings from formal areas);
  - ii. War Memorial Hospital buildings of aesthetic importance: main building, chapel;
  - iii. 1920s landscape items including: palm trees, cast iron bollards, reconfigured gates to Birrell Street / Bronte Road and new gates to Carrington Road;
  - iv. The Victorian landscape and landscape elements both existing and reinstated based on documentary evidence.
  - v. External views from Centennial Park of the Norfolk Island Pines;
  - vi. Existing views of the Ellerslie, Banksia and Wychazel houses along Birrell Street, and Vickery tower from Carrington Road. The Carrington Road wrought iron gates from c1920.
- (b) The Victorian garden space adjacent to the Edina building identified is to be treated to reflect its significance and historical appearance.



- (c) A lower garden space is to be created that interprets the pond featured in the original central garden space through landscaping layout, inclusion of a water feature, or signage interpretation. The original height difference between the upper lawn and carriageway is to be maintained and linked by existing stone stairs.
- (d) The lower garden space described in (c) should at a minimum, retain the trees identified in Figure 2 and seek to retain as many existing mature trees as possible across the site.
- (e) Any trees present considered as having ‘High Significance’ or ‘Exceptional Significance’ in *Annexure E7-1 – Conservation Management Plan 2017*, which are not displayed in Figure 2 and not contained within the new building zones displayed in Figure 3, should be retained.
- (f) Any trees identified on the *Waverley Significant Tree Register* are subject to the relevant provisions in Part B3 - Landscaping, Biodiversity and Vegetation Preservation.
- (g) Ensure that the design of the central building is such that the significant fig near the existing tennis court is retained, along with the significant magnolia grandiflora, and their wellbeing preserved.
- (h) Maximise the protection of significant trees on the site and their corresponding tree protection zones.
- (i) The original estate gates at the corner of Bronte Road and Birrell Street are to be retained and maintained and celebrated as the traditional formal entry point to the site. This must include the use of the gates as a pedestrian access to the site. A pathway is to be provided from the gates leading into the site. This pathway is to be publicly accessible and must align with the controls specified in 7.5 Public Domain and open space.
- (j) The eastern Birrell Street entrance is to be preserved, through the retention of the avenue of Canary Palms and the experience of a late Victorian streetscape.
- (k) Ensure that the appropriate standard of professional and craft expertise corresponds to the grade of significance through involvement of a qualified heritage consultant.

---

#### 7.4.2 New buildings and landscape

- (a) New buildings adjacent to the Victorian private road or a building of significant fabric as identified in Figure 2 are to read as contributing or harmonising to the heritage buildings.
- (b) The scale of new buildings should be of a scale consistent with the controls outlined in the WLEP. New buildings should respect the landmark qualities of the Edina tower or the Norfolk Island pines.
- (c) Site lines that link open spaces are to be created and framed through the site.
- (d) Should demolition or excavation works involve areas of potential archaeological deposits, plan for proper investigation and interpretation of those deposits.
- (e) Fabric of new buildings must be sympathetic to the palette and colour of historic materials used in the original estate.

---

#### 7.4.3 Heritage Interpretation and Reconstruction

- (a) The place is to be interpreted as the whole estate developed by the Vickery

- Family as a residence, and then as the War Memorial Hospital.
- (b) The original carriageway on the corner of Bronte/Birrell St is to be interpreted via the site layout and wayfinding throughout the site.
  - (c) Any additions to heritage buildings are to present as distinguishable, at least on close inspection, in accordance with Burra Charter principles. Their design should also be sympathetic and not detract from the appreciation of the heritage buildings and their significance.
  - (d) Creatively interpreting aspects of the history of the place should be considered as opportunities arise, including:
    - i. Develop the site with an appreciation of its identity as a single planned estate;
    - ii. Develop the site with an appreciation of the spatial order of the estate, which is contiguous over the course of its history as an estate and hospital.
    - iii. Develop and creatively interpret Aboriginal connection to place in combination with European heritage, through an understanding of native landscapes and planting of Sydney's Eastern Beaches.
  - (e) The reconstructions, removals and plantings should be considered in accordance with the policies set out in the *Conservation Management Plan 2017* provided in Annexure E7-1.

---

#### 7.4.4 Landscaping

- (a) A minimum of 40% of the site is to be provided as landscaped area.
- (b) Notwithstanding the principal deep soil zones displayed in Figure 4, a minimum of 30% of the site is to be provided as deep soil area, as specified in the WLEP.
- (c) Retain, replace or reinstate trees and other species to support the habitat corridor which affects the entire site.
- (d) Provide a Landscaping Plan that identifies the trees and plants that contribute to the habitat corridor, including a Succession Plan that identifies how these plants will be managed over time.
- (e) Provide indigenous species throughout the site with sensitivity to European landscaping.

---

#### 7.4.5 Public Art Heritage Interpretation Plan

- (a) A public art and heritage interpretation plan is required to be submitted with any Development Application to demonstrate how the heritage of the site has been interpreted through landscape design, species choice, wayfinding and digital interpretation on the site.
- (b) The public art and heritage interpretation plan is to provide clear and engaging interpretation that acknowledges the periods of ownership: indigenous custodianship, 50 years with the Vickery family, and 100 years as a hospital.
- (c) Public artwork is to be provided in accordance with Part B11 Public Art of this DCP.

## 7.5 PUBLIC DOMAIN AND OPEN SPACE

### Objectives

- (a) To encourage a cool microclimate within the precinct.
- (b) To encourage public access and engagement with the heritage of the site.
- (c) To cultivate spaces that encourage mental and physical wellbeing.
- (d) To promote social cohesion and connectedness.
- (e) To contribute to the key environmental targets in Council's strategic plans.

### Controls

- (a) Invited publicly accessible open space is to be provided as identified in Figure 4.
- (b) Where open space is to be publicly accessible, these spaces should be open to the public at a minimum of 9 daylight hours. Where fences or gates are to be included, these are to be arranged in an 'open' fashion between open hours to encourage movement through the site.
- (c) The management around the operation of any fences or gates surrounding publicly accessibility, including any exceptional circumstances in which opening hours may need to be altered, should be included in a Plan of Management for the site.
- (d) Provide primary and secondary through site links for pedestrians to increase permeability across the site, as identified in Figure 5.
- (e) The invited publicly accessible outdoor areas are to be accessible and designed with a mix of shade and direct sun throughout the year.
- (f) Consider the provision of accessible vegetable garden beds and facilities (e.g. tools, composting) for collective activities.



Figure 4 Site plan identifying general hierarchy of open spaces and principal deep soil zones.

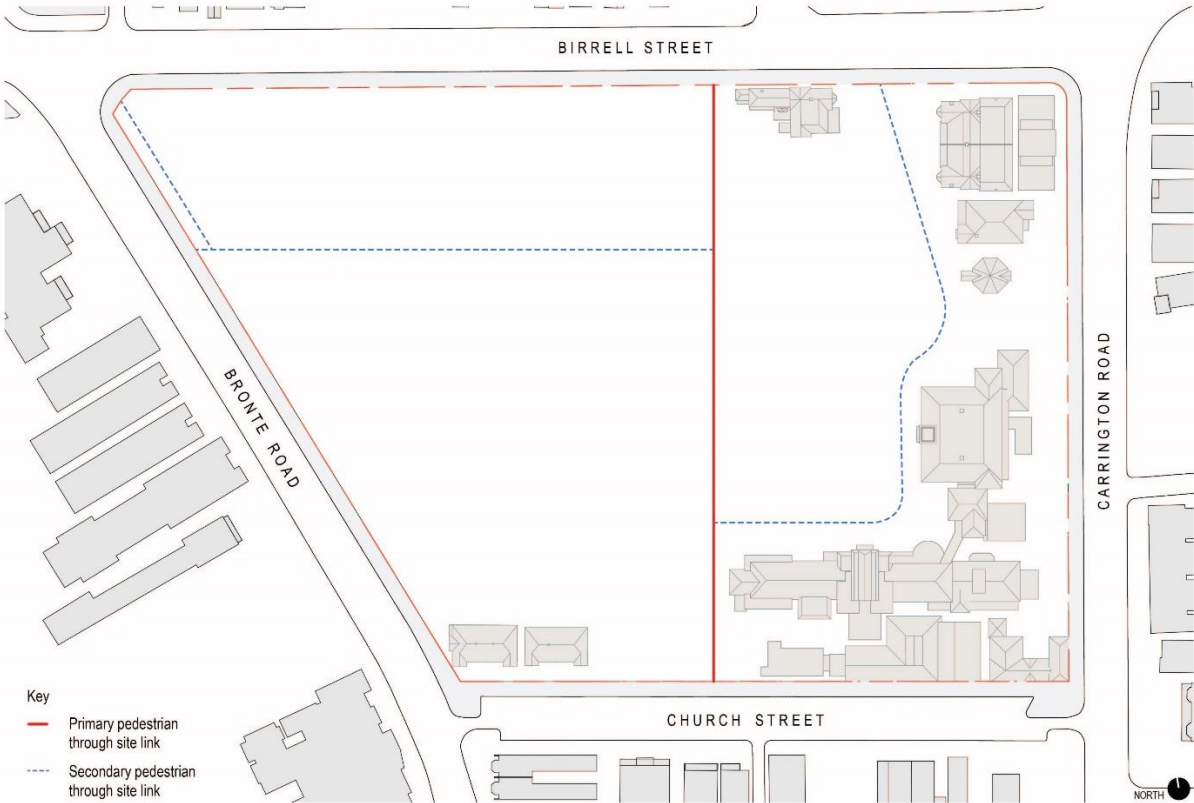


Figure 5 Site plan identifying through site links

## 7.6 URBAN ECOLOGY

### Objectives

- (a) To protect and enhance the natural habitat for a range of species as part of the heritage values of the site.
- (b) To encourage the creation of a cool micro-climate on the site.
- (c) To provide a resilient and biodiverse outdoor space.
- (d) To maintain and enhance the biodiversity corridor connectivity from Waverley Park to Queens Park.
- (e) To contribute to key environmental targets in Council's strategic plans.

### Controls

- (a) Canopy coverage is to be provided at a minimum of 30% of the site area. This is to be demonstrated on the Landscape Plan and inclusive of landscape on slab.
- (b) Canopy coverage is to provide an appropriate cover that respects the heritage values of the place while providing a recognised habitat corridor through the site. Details of how the canopy, particularly the habitat corridor, will be maintained and managed over time is to be provided (via a Canopy Succession Plan).
- (c) Preserve and maintain the existing mature trees on the site. Where a tree cannot be maintained due to the location of a new building, this tree is to be relocated or replaced with a comparable size and species in a more suitable location on the site to support the habitat corridor.
- (d) Protection of trees on site that are to be retained is to be conducted in accordance with the provisions in Part B3.4 Protecting Trees on Development Sites in the WDCP.
- (e) Buildings are to be located to support the Habitat Corridor which runs through the site. The Habitat Corridor is to be clearly marked on the Landscape Plan with details of the proposed species and the arrangement and structure of the habitat.
- (f) In addition to the Habitat Corridor through the site, habitat species are to be planted along the periphery of the site, in the setbacks from the street frontage. This habitat is also to be clearly marked on the Landscape Plan.
- (g) At-grade car parking and roads are to be minimised within the habitat corridor to encourage a safe environment for fauna within the limitations of the site and heritage values.
- (h) A diversity of plant species is to be provided across the site.
- (i) Landscaping is to be designed and completed in a way that provides adequate fauna habitat, i.e. taking vertical space into consideration as well as horizontal space, and providing several layers of plantings. It is expected that a shrub layer 0.5 to 2.0 m will be included in at least some sections of the habitat corridor, and that some shrubs and grasses are planted in thickets to provide safe habitat for smaller fauna species. In addition, new trees are to be provided at 200L to provide for increased habitat to the periphery of the site.
- (j) Refer to the species outlined in Table 1 that are encouraged or discouraged for this site. The planting palette should include a range of species. Additional or alternate species to this list can be discussed with Council's Urban Ecology

- Team. Proposed species are to be detailed in the Landscaping Plan.
- (k) Where appropriate, deciduous trees such as *Melia azedarach* var. *austraasica* are to be planted near windows, particularly on the north and west aspects, to provide shading in summer and filtered sunlight in winter.
  - (l) Wildlife-friendly lighting is to be provided across the site to enable fauna movements, particularly at nighttime. Design responses that include soft (lower wattage), low-placed lights facing downwards with a warm colour temperature (less than 2500K), are preferable to up-lighting, lighting from high on poles (even if facing downwards), bright lighting (higher wattage) or lighting with a cool or blue cast.
  - (m) Pollinator-friendly species are to be provided on-site with details in the Landscaping Plan. Pollinator species typically have small, white cream, yellow, blue, or purple flowers.

<i>Table 1 – Preferred and discouraged species</i>			
Preferred Species			Discouraged Species
Shrub Layer	Trees	Ferns	
<i>Goodenia ovata</i>	<i>Eucalyptus haemastoma</i>	<i>Asplenium</i>	Liorpe
<i>Cordyline stricta</i>	<i>Pittosporum revolutum</i>	<i>australasicum</i>	Purple Corydyline
<i>Doryanthes excelsa</i>	<i>Leptosperumum</i>		<i>Rapheolepis</i>
<i>Baeckea linifolia</i>	<i>laveigatum</i>		
<i>Banksia spinulosa</i>	<i>Leptosperumum</i>		
<i>Austromyrtus dulcis</i>	<i>sqarrosum</i>		
<i>Ozothamnus</i>	<i>Backhousia citriodora</i>		
<i>diosmifolius</i>	<i>Elaeaocarpus reticulatus</i>		
<i>Conospermum</i>	<i>Podocarpus elatus</i>		
<i>taxifolium</i>	<i>Macadamia integrifolia</i>		
<i>Eristoemon</i>	<i>Backhousia citriodora</i>		
<i>australasius</i>	<i>Melia azedarach</i>		
<i>Isopogon</i>	<i>Brachychiton acerifolius</i>		
<i>anemonifolius</i>	<i>Brachychiton populneus</i>		
<i>Boronia parvifolia</i>	<i>Grevillea robusta</i>		
	<i>Casuarina</i>		
	<i>equisteifolium</i>		
	<i>Tristaniopsis laurina</i>		
	<i>Davidsonia jerseyana</i>		
	<i>Tristaniposis laurina</i>		
	Citrus trees such as lemons and limes		

## 7.7 HIGH-PERFORMANCE BUILDINGS AND SITE RESILIENCE

### Objectives

- (a) To ensure a high level of sustainability across all elements of the estate.
- (b) To optimize opportunities for environmentally sustainable design to minimise carbon emissions, energy use, potable water use and waste.
- (c) To encourage a low-carbon, high-performance precinct to help Waverley work towards its target of net-zero emissions.
- (d) To ensure buildings are well-designed to minimise energy consumption as well as maximise the thermal comfort for the occupants.
- (e) To promote the use of on-site energy generation and storage.
- (f) To ensure the site and buildings are designed to reduce potable water consumption.
- (g) To protect water quality and promote appropriate water harvesting and on-site storage and use of harvested/recycled water.
- (h) To minimise the impacts of the urban heat island effect.
- (i) To minimise the impacts of drought or water shortages.
- (j) To minimise impacts from severe storms or flooding events.
- (k) To support key environmental targets in Council's strategic plans.

### Controls

#### 7.7.1 Energy use and production

- (a) Building location and façade design is to maximise access to direct sunlight to reduce reliance on mechanical heating.
- (b) Adequate external shading or performance glass is to be provided on the western and north-western building facades to minimise the cooling load required in mid-summer.
- (c) Any on-site renewable energy sources are to be coupled with battery storage.
- (d) The residential component of a building is expected to exceed BASIX Energy, Water and Thermal Comfort targets as specified in the WLEP.
- (e) Commercial buildings shall achieve a Green Star Certified Rating of six (6) stars; and/or a NABERS 5.5-star energy rating and 4.5-star water rating as specified in the WLEP.

#### 7.7.2 Urban Heat Island

- (a) To mitigate the accumulation of urban heat, buildings are to utilise light coloured and reflective materials, and where possible provide vegetative surfaces such as green roofs.
- (b) Buildings and roof materials are to be a light coloured material to reduce solar absorption.
- (c) Pavements are to mitigate heat accumulation where possible through materials which consider end users and that maximize permeability and/or reflectivity.
- (d) Provide one building in the precinct able to function as an accessible refuge for on-site residents from the heat in the case of emergency, with access to a back-up power supply available on the site.

---

**7.7.3 Water**

- (a) Principles of Water Sensitive Urban Design (WSUD) are to be applied across all aspects of the development to minimise stormwater discharged from the site and ensure any stormwater has minimal impact on local waterways and drainage infrastructure.
- (b) Provide fit for purpose water harvesting, re-use, and on-site storage.
- (c) Maximise indoor and outdoor water efficiency in order to reduce potable water consumption.
- (d) Design to increase resilience to flooding and drought and integrate with stormwater quality, quantity and urban canopy/greening requirements.
- (e) Maximise permeable areas and materials across the site to reduce runoff and better manage stormwater capacity.
- (f) Minimise infrastructure and utility conflicts to prevent damage in storms.



## 7.8 TRANSPORT AND SITE ACCESS

### Objectives

- (a) To reduce the reliance on private vehicle usage.
- (b) To minimise conflicts between pedestrians and vehicles.
- (c) To ensure the provision of an appropriate number of vehicular spaces having regard to the proposed operating activities on the land. The intensity of these uses should aim to minimise traffic congestion and waiting time at intersections.
- (d) To promote bicycle usage to and from the site.

### Controls

---

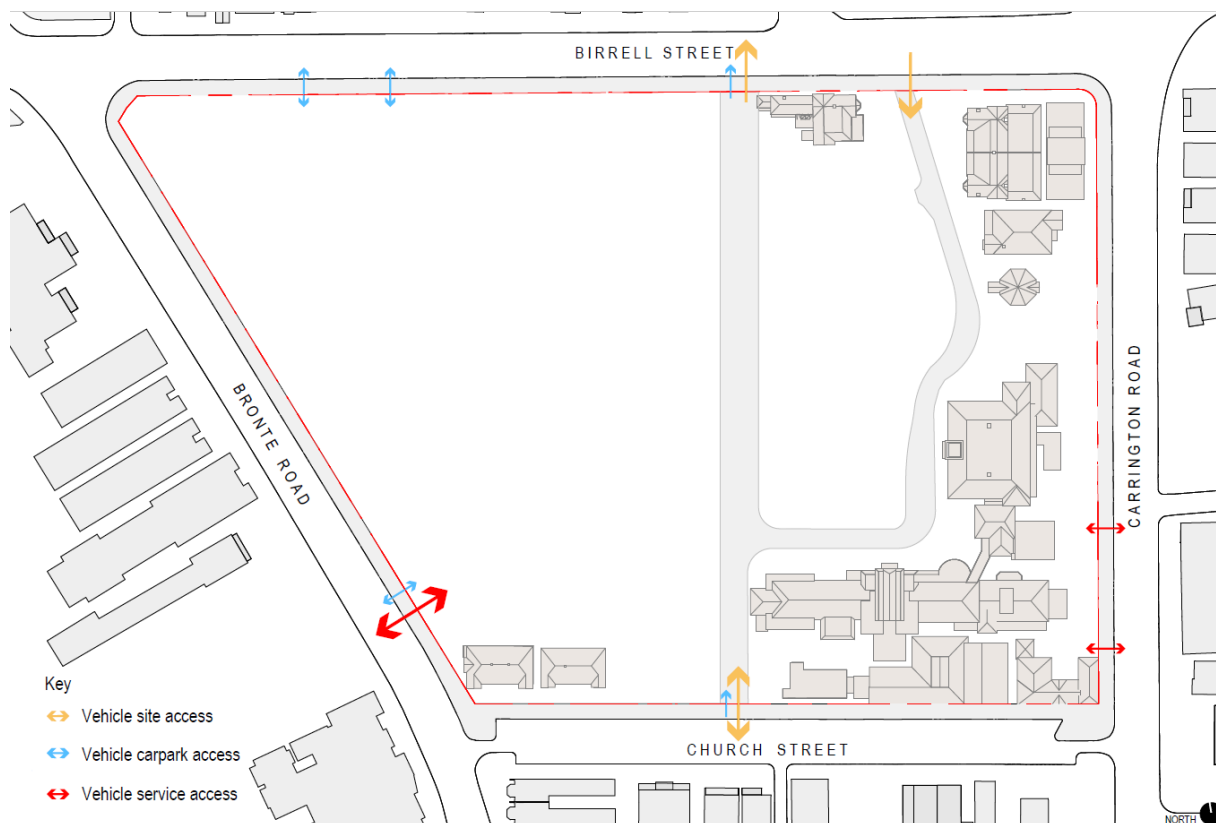
#### 7.8.1 Loading Facilities

- (a) Loading for RAC, commercial and hospital facilities should be accessed from Bronte Road.
- (b) Loading for residential facilities should be located to ensure easy access for residents, removalists and waste collection services while ensuring adequate amenity and safety for surrounding uses.
- (c) Loading facilities should be visually concealed where possible within building envelopes.

---

#### 7.8.2 Driveways and Vehicle Access

- (a) Vehicle access to the site is to be provided in accordance with Figure 6.
- (b) Vehicle access through the site is to be designed to ensure the safety of visitors and residents, whilst encouraging pedestrian movements across the site.
- (c) Any vehicle access that may be provided via Bronte Road, must be designed to minimise vehicle, cyclist and pedestrian conflicts, and must not create unreasonable service disruption to the intersections surrounding the site.
- (d) Traffic modelling is to take into account busy traffic periods during school zone times.
- (e) Service vehicle movements across the site should be managed to minimise vehicle and pedestrian conflicts, and to maximise pedestrian amenity.



**Figure 6: Vehicle access**

### 7.8.3 Parking

- (a) On-site staff car parking is to be minimised to the extent that it does not affect the operation of the site and its facilities.
- (b) Car parking must not be sub-leased out to external users.
- (c) Car parking is predominantly to be provided in basements underneath the buildings on site.
- (d) Consolidated basements between buildings are to be designed to maximise deep soil across the site.
- (e) The car parking rate for independent living units and residential aged care is to be in accordance with the provisions of any relevant Environmental Planning Instrument that governs the provision of Seniors Housing.
- (f) Bicycle parking, lockers and changerooms are to be provided at the rates specified in Part B General Provisions of this DCP. These facilities should be accessible and attractive. Where provided in a basement the facilities are not to contribute to the calculation of gross floor area.

### 7.8.4 Electric Vehicles

- (a) Provision for electric vehicle charging stations is to be provided in accordance with Part B7.8 Electric Vehicle Charging Points of the WDCP.
- (b) A dedicated space and charging point for electric bicycles and mobility scooters to be charged must be provided.
- (c) Car share is to be provided at the rates specified in Part B7.7 Car Share of the WDCP.

## 7.9 WASTE

### Objectives

- (a) To minimise conflicts between pedestrians, traffic and waste collection.
- (b) To ensure a pleasant campus environment.
- (c) To minimize impacts of large vehicles on new and proposed open spaces.
- (d) To provide for the efficient and safe collection of waste across the site.
- (e) To ensure buildings are designed to enable the safe and concealed storage of waste on-site.
- (f) To provide for adequate waste storage for the proposed use of each building.

### Controls

- (a) Development is to comply with the requirements of B1 Waste of this DCP.
- (b) Bins are not to be presented on street for collection.
- (c) On-site collection is to be provided for, and where possible to be collected from within a building footprint.
- (d) Residential waste and recycling are to be clearly separated from RAC, hospital and commercial waste and recycling.

## ANNEXURES

## ANNEXURE E1-1 WIND TUNNEL STUDY

Wind Tunnel Study is to be prepared for all building over 9 storeys in height or is considered exposed. This is the most definitive method of modelling wind effects. Wind effects are modelled in a wind tunnel facility and local speeds are measured at the various critical outdoor areas within and around the site and compared directly against the relevant comfort criteria. Any recommendations for treatments such as altering the building form, the implementation of awnings, canopies, strategically placed screens or dense planting to protect entrances or podium areas should be modelled in the wind tunnel and tested.

#### Requirements for the preparation of a wind tunnel report

1. The Wind Tunnel Study required under this plan should
  - (a) Assess the likely wind effects of the development;
  - (b) If the wind conditions in any of the areas surrounding the site exceed the relevant criteria then model the existing wind conditions to accurately quantify the impact; and
  - (c) Recommend measures required to improve adverse wind conditions created by the proposal and demonstrate that the recommended measures will be effective in mitigating the adverse wind effects.
  
2. Wind tunnel tests must be carried out as follows:
  - (a) Surround models are to be placed around the model of the proposed building to a radius of approximately 500m. The model scale should not be smaller than 1:500.
  - (b) The boundary layer flow pertaining to the upstream terrain from the various wind angles must be reproduced at the appropriate scale. This includes the modelling of the variation with height, of mean velocity and turbulence intensity of the wind, up to the height of the boundary layer. Other modelling parameters that must be considered are the integral scale of turbulence of the wind, the effect of scale on the Jensen and Reynolds numbers and a zero longitudinal pressure gradient. The Jensen and Reynolds numbers are dimensionless numbers used to predict full scale results from tests performed using reduced scale models. Note that the mean wind speed and turbulent intensity boundary layer profiles must be modelled to within 10% of the target values. It is recommended that the target values be based on the Deaves and Harris (1978). Bondi Junction Centre Waverley Development Control Plan 2010. The integral scale of turbulence must be matched to within a factor of 3. The maximum permissible blockage is 10% (maximum sectional area of the model divided by the sectional area of the wind tunnel test section). The maximum height of the model must not exceed half the height of the wind tunnel test section. The minimum permissible Reynolds Number is  $5 \times 10^4$ .
  - (c) Measurements of local wind velocities should be based on the maximum 2 to 3 second duration gusts (in full scale), taken from a sample length of 1 hour (in full scale). If the gust-equivalent mean criteria are used then the mean and local turbulence intensity should also be measured.

- (d) Analysis of the wind effects must be based on measurements taken from an adequate number of locations, covering all the potentially affected areas. For each of the locations, wind speed measurements should be taken from a minimum of 16 wind directions. Initial tests to be performed without the effect of the proposed trees or other wind mitigation devices.
- (e) Analysis of results must be based on reliable meteorological data for Sydney (preferably from the Sydney Airport Observation office), taken over a minimum of 30 years of continuous data. In the case where treatments are required, their effectiveness must be confirmed with further wind tunnel measurements.

## ANNEXURE E2-1 DESIGN GUIDELINES

The elements shown in each group are drawn from buildings in the Bondi Beachfront Area and represent a selection of representative types and building scale for reference purposes. In all cases, site specific requirements and physical parameters will affect the design solution. As well, the vitality of individual choice extends and enriches the design process.

The guidelines are provided as diagrams rather than being prescriptive. This allows interpretation with the wide range of materials and styles while at the same time, providing variety and flexibility, thereby uniting the street in urban design terms and providing a high degree of continuity.

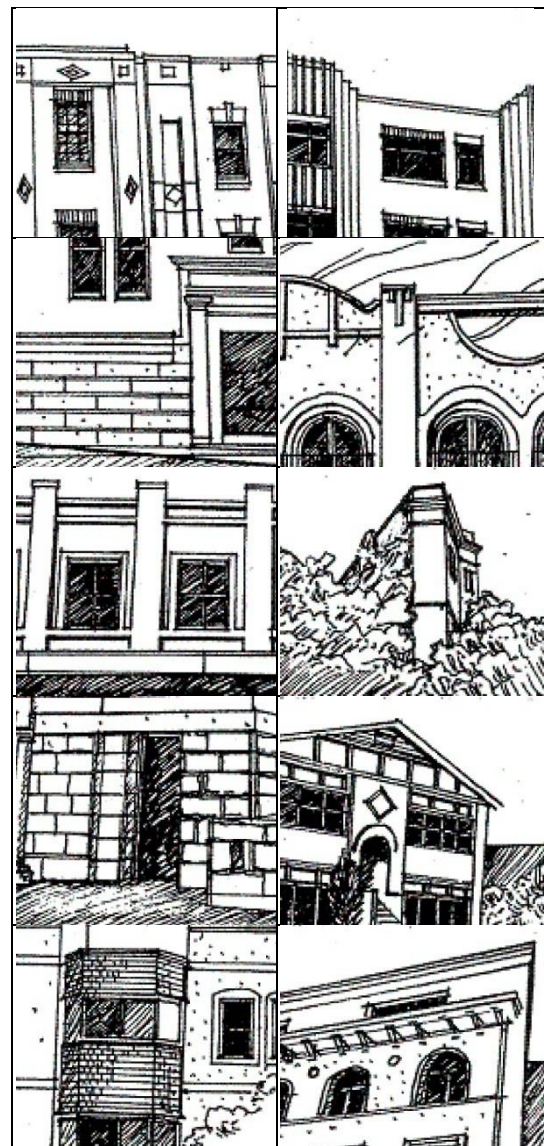
### WALLS

The Bondi Beachfront Area includes buildings with almost every type of masonry wall finish, with timber used as panelling in gables, balconies, bay windows and other secondary uses.

The embellishment of walls, roofs and parapets exemplifies the stylistic differences of each succeeding period. Walls and their concluding parapets are visually important and the development of wall surfaces with a multiplicity of textures and patterns also provides interest and character to otherwise bleak buildings. New buildings should continue this tradition and avoid the bland unornamented brick surfaces of recent unit development.

Materials include:

- Brick
- Render
- Stone
- Roughcast
- Fibre Cement Sheet
- Shingles
- Timber

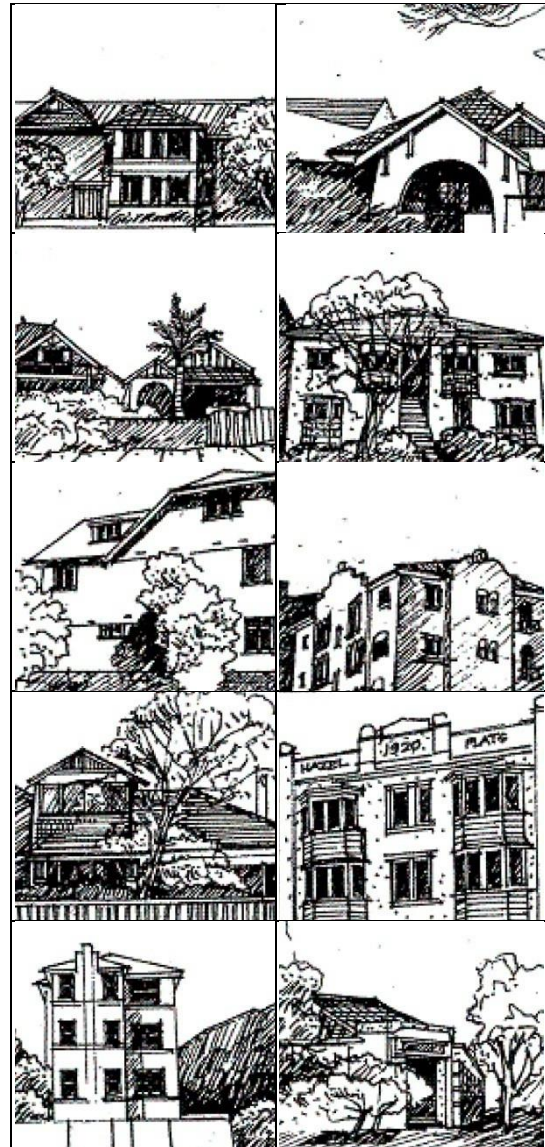




**ROOFS**

No one type of roof type predominates with most forms of roof represented in the Bondi Beachfront Area. The resultant architectural variety provides constant visual interest and is to be encouraged. Junctions of roof and wall also vary, with a wide range of eaves and parapet types used singly and often in combination.

Continuation of this character is to be encouraged and flat roofs without parapets are generally to be avoided

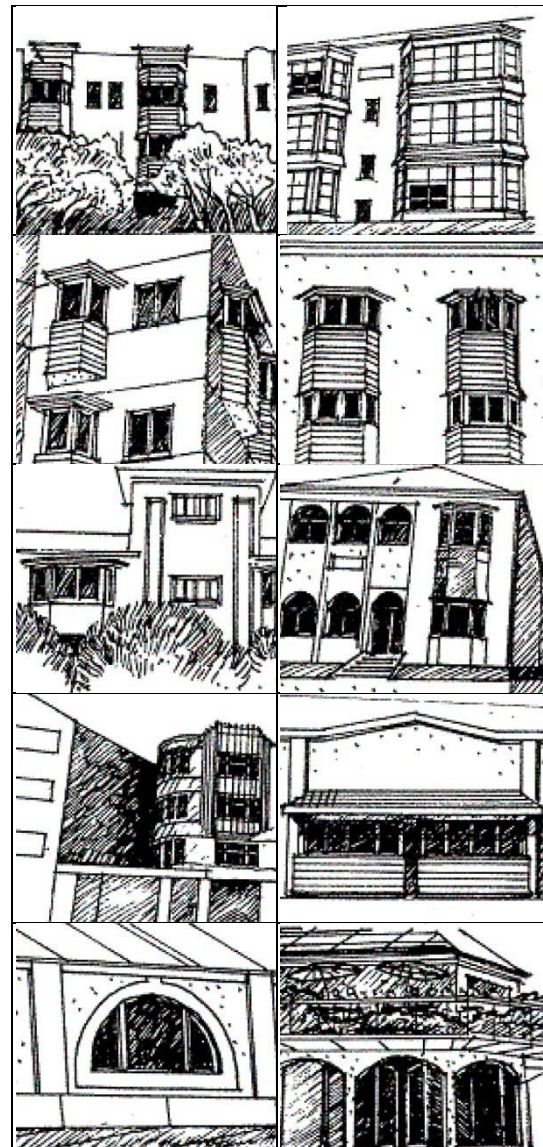


## WINDOWS

Buildings in the Bondi Beachfront Area have a rich variety of window types, which reflects the resort character of the area.

Much building in the area is at an urban scale with use of details appropriate to the larger scale. Externally, the architecture of the area and the corresponding window type varies from Victorian, through various Interwar styles including Art Deco and Spanish Mission to the faceless expression of four storey walk-ups and developer modern.

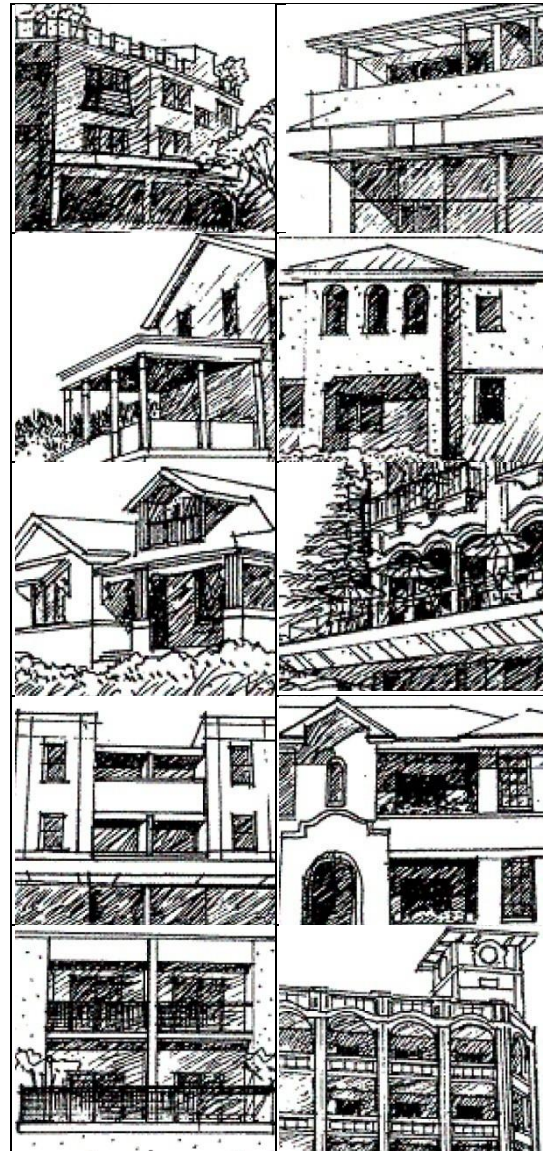
Windows reveal extraordinary inventiveness and variation of size, shape and detail. In addition to the variety of types and styles of standard windows, there are numerous types of bay windows, which provide greater access to views and sunlight. The continued use of windows that enrich and enliven the facades of buildings in the core area is desirable. It should be noted that the range of windows illustrated is by no means exhaustive.





**BALCONIES AND VERANDAHS**

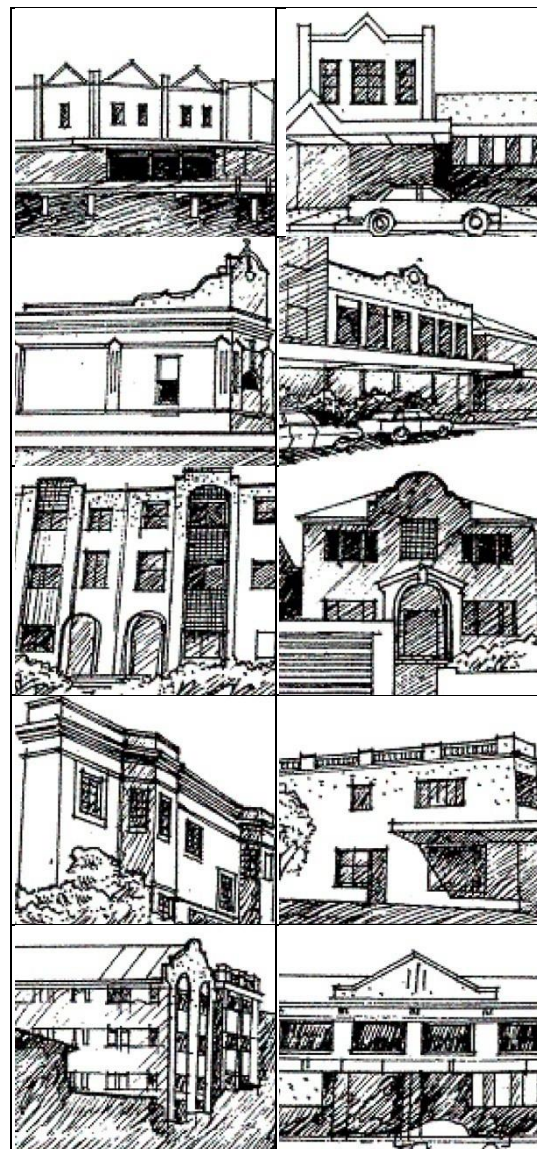
Balconies and verandahs are evident throughout the Bondi Beachfront Area in all types and scales. Widely used in the area are large covered balconies or verandahs in flat buildings. These spaces function effectively as outdoor rooms for recreational use in summer, giving views, light and air to flats which would be otherwise small and without immediate access to external open space. In addition to the “traditional” verandah room evident on much flat development, terraces in first floor awning locations and at top floor levels set back behind balustrades are to be encouraged.



**PARAPETS**

Parapets form a distinct and characteristic element in commercial and larger scale residential buildings. Styles in the Bondi Beachfront Area include Classical, Victorian, Art Deco, Spanish Mission and other hybrid types. The various styles are used to effect on both linear and corner elevations, enlivening buildings of utilitarian character that would otherwise be commonplace.

The use of all types of parapets in new development is to be encouraged to continue to develop the building traditions in the Bondi Beachfront Area.



## COLOUR

Colour in the Bondi Beachfront Area reflects both periodic change in community taste and the availability of building materials over time. In terms of natural materials, the use of sandstone as a plinth with the characteristic brown dry pressed or the clinker burnt purple brick above provides a traditional colour palette.

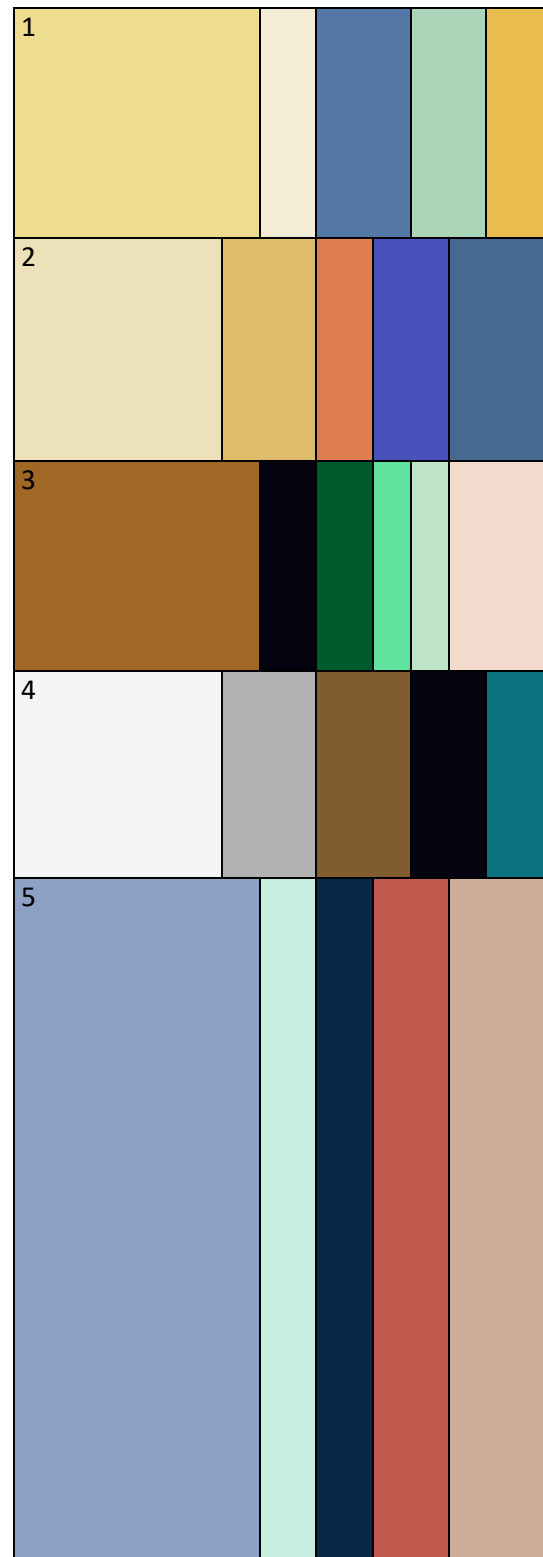
Colours shown at the top right (1) are typical of the colour palette for Campbell Parade adopted by Council in 1988. This scheme reflected in the beachside character of the area with complementary sand and sea colours in the high to mid tone range.

Four alternative schemes are shown (2 - 5). These stay within the sand and sea: range but strengthen tonal contrast and include richer, more saturated hues. Whilst embracing a broader range of colours, the proposals avoid the purple/red segment of the spectrum, and mud/olive colourings.

Sample colours taken from the Taubmans range are (left to right):

1 Sambu (T22-3W) Cameo Lace (T2-3W) Mariner Blue (T74-7A) Portolina (T79-4W) Golden Globe (T22-6A)	4 Portland Stone (T122-2W) Woollooware (T122-5W) Mascari (T116-7A) Mojo (T172-8B1) Deep Splendor (T79-7A)
2 Seersucker (T106-3W) Warm Ochre (T22-5A) Russet Ridge (T130-7A) Saxon Blue (T62-8N) Blue Masque (T71-8A)	5 Dragonfly (T151-5W) Shy Green (T152-3W) Sea Deep (T149-8N) Earth Tone (T34-7A) Baked Dough (T27-4W)
3 Plaza Buff (T115-80) Mojo (T172-8B1) Emerald Turp (T82-8N) Fantasy Green (T81-7A) Oceanic Forest (T83-2W) Lambs Tail (T116-1W)	

*Please note the sample colours shown are indicative only.*



The colour ranges are provided for guidance in the development of colour schemes appropriate for each building, with reference to size, location, style and other specific conditions. They are therefore not definitive colour schemes but should be regarded as an indication of the scope of colour suitable for the preparation of schemes for individual properties.

Some general principles apply:

- (a) Upper storeys which are set back should be the same colour or preferably a darker colour, as the lower floors of the building as light or strong colours visually come forward.
- (b) Strong elements of the façade should be visually balanced, e.g. in general terms, vertical elements such as columns and pilasters look best linked with horizontal elements painted the same colour.
- (c) Under awning and colonnades, high tones should be used to reflect both artificial and natural light.
- (d) When economy dictates a limited palette, select a lighter tone to emphasise the modelling of desirable architectural detail. Darker tones will reduce the visibility of poorly detailed facades.

## ANNEXURE E3-1 TYPICAL BUILT FORM FOR TWO STOREY CENTRES

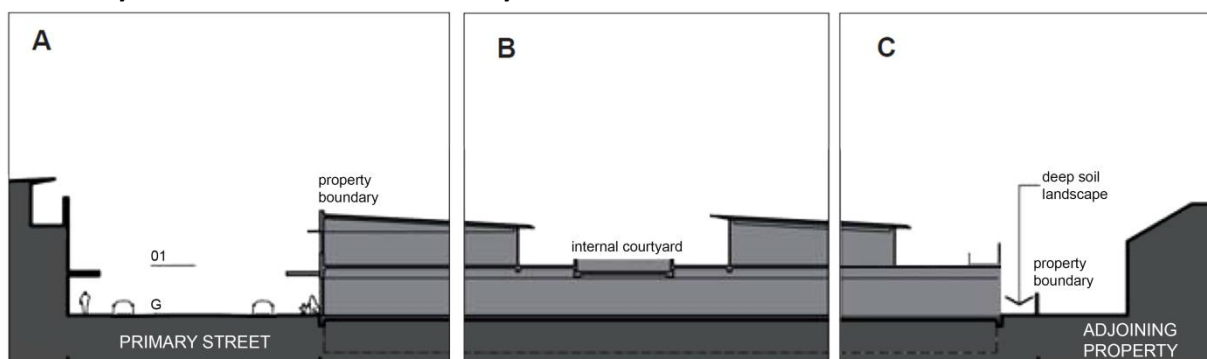
Annexure E3-1 applies to the following centres:

1. Murriverie Road Centre.
2. Belgrave Street Centre.
3. Macpherson Street Centre (properties east of 38-40 Macpherson Street, not including)

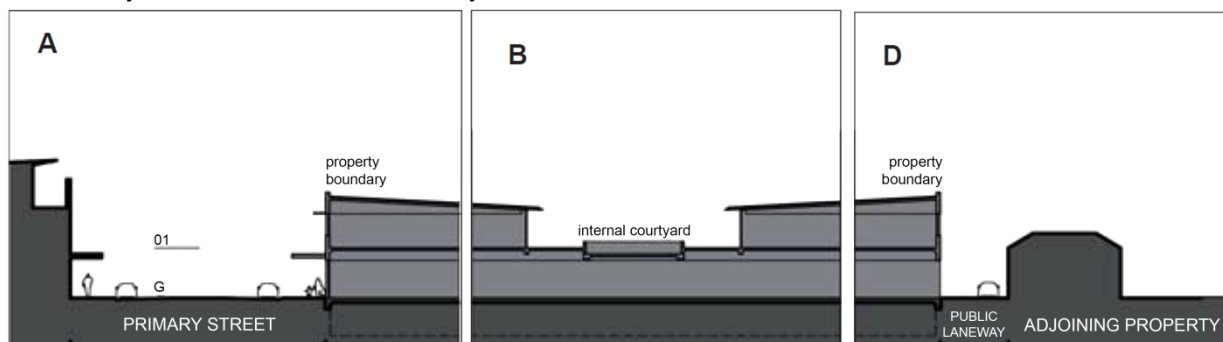
There are two typical built forms for two storey Local Village Centres which are dependent on whether the property has access to a rear lane.

- a) Properties without rear laneway: Control Diagram A, B and C.
- b) Properties with rear laneway access: Control Diagrams A, B and D.

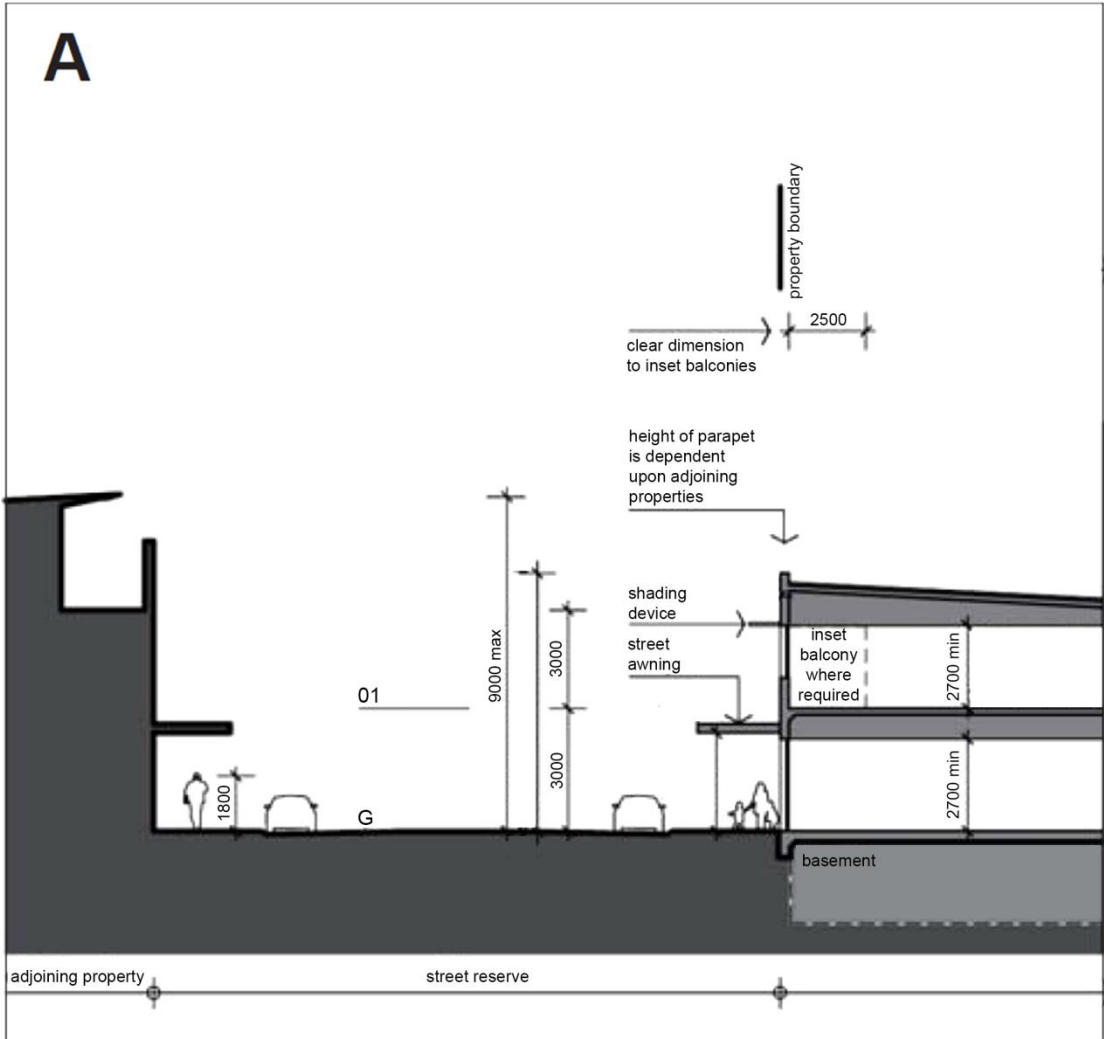
### Two storey section – without rear laneway



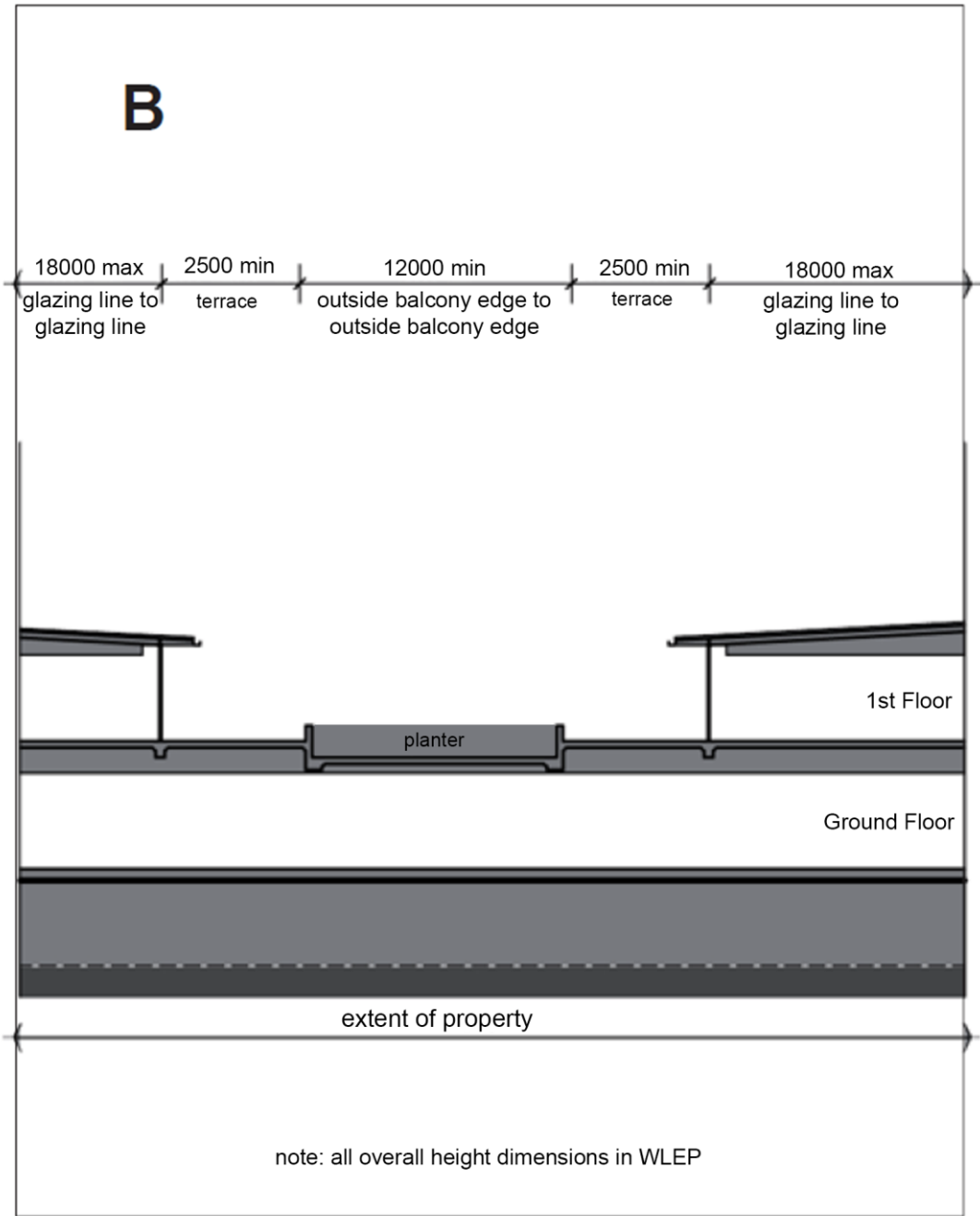
### Two storey section – with rear laneway



Two (2) storey detailed street frontage and internal floor to ceiling heights

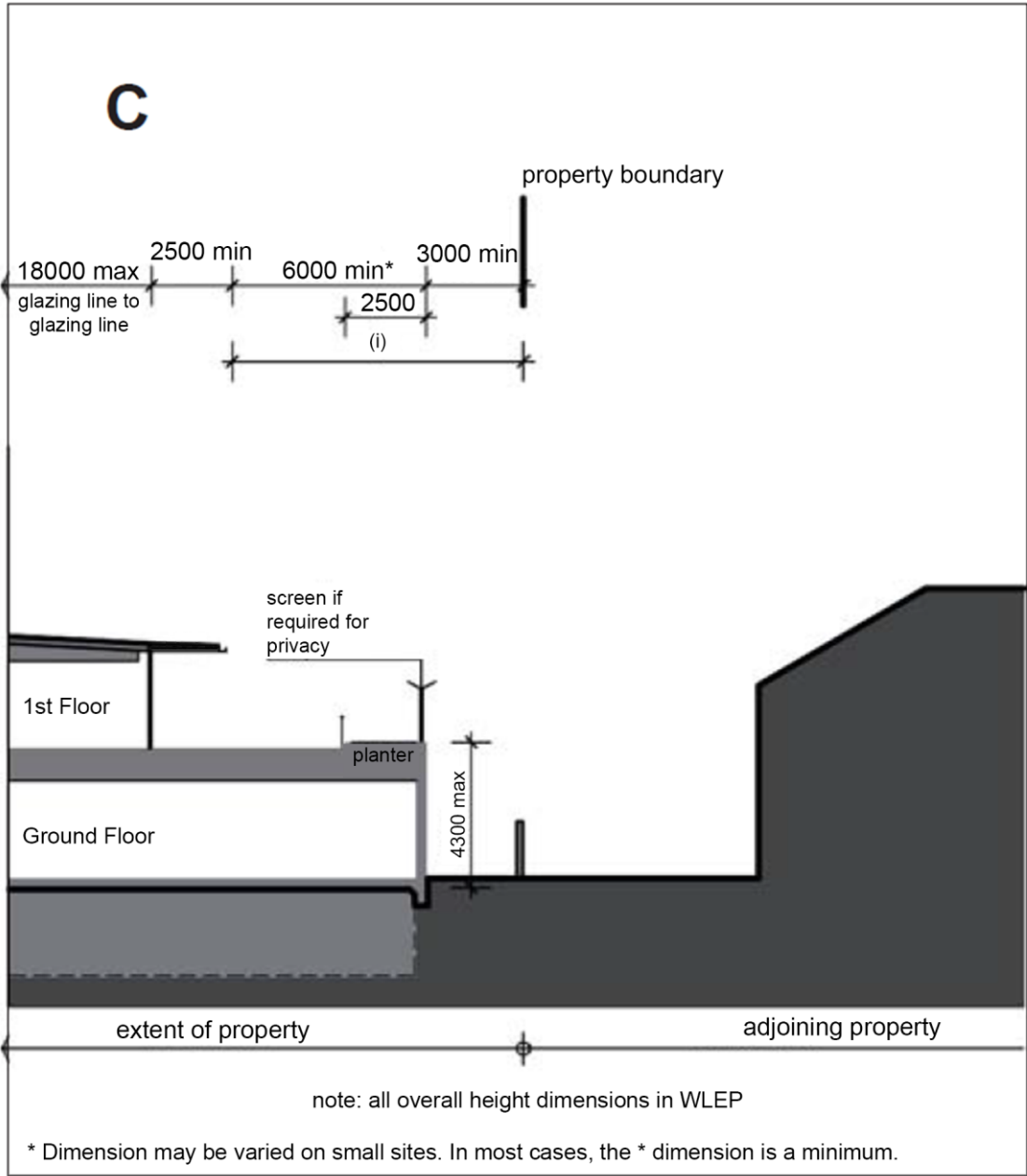


Two (2) storey detailed internal courtyard



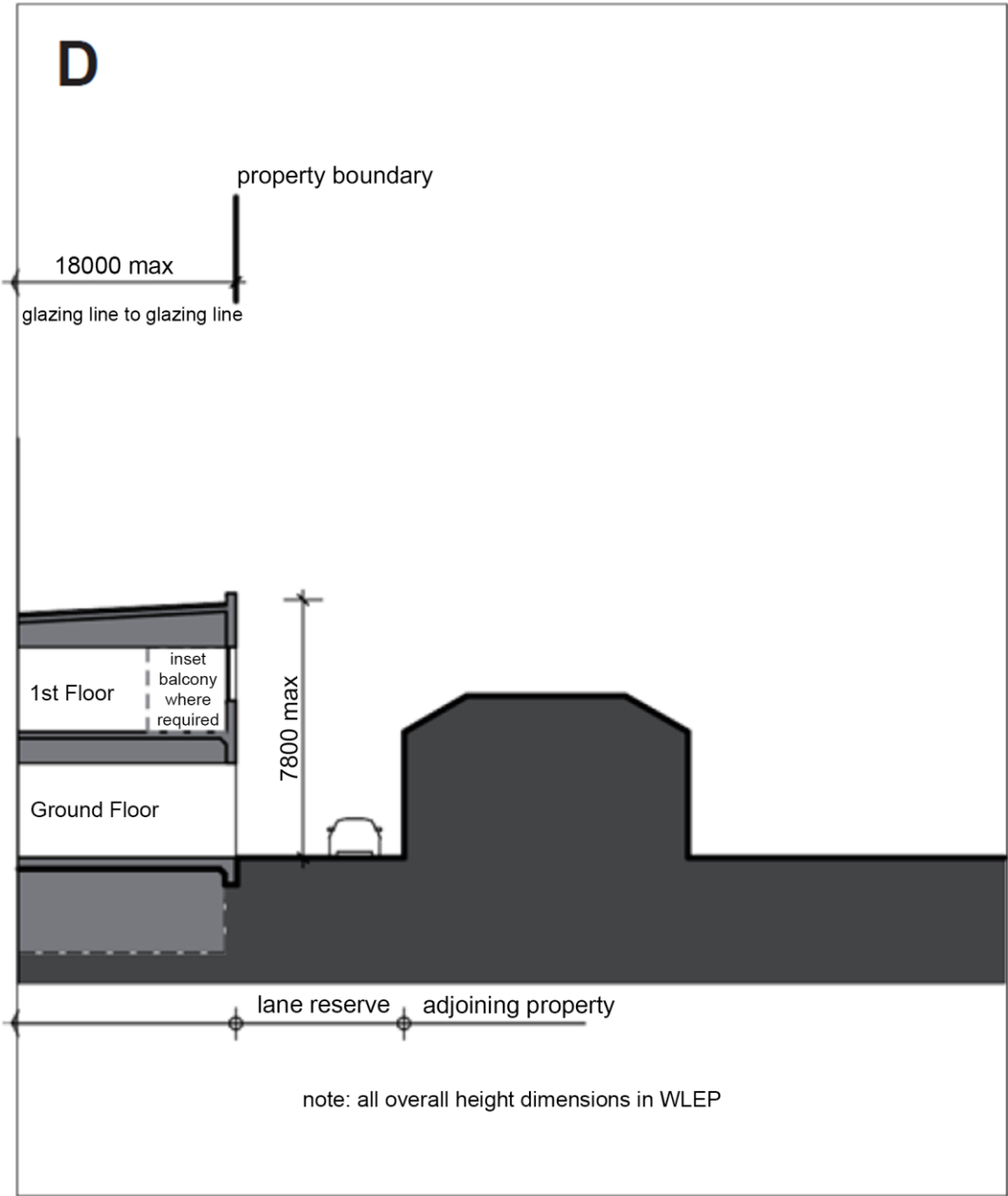


Two (2) storey detailed rear setback without rear laneway





Two (2) storey detailed section with rear laneway



## ANNEXURE E3-2 TYPICAL BUILT FORM FOR THREE STOREY CENTRES

Annexure E3-2 applies to the following Local Village Centres:

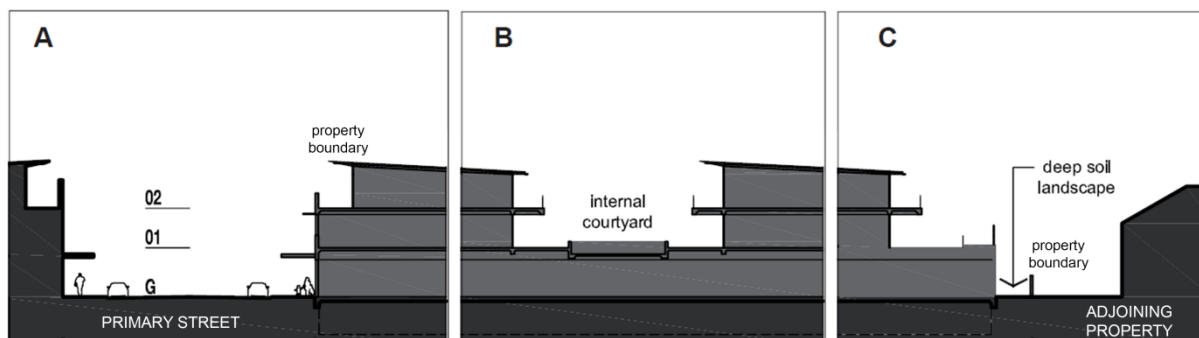
1. Bondi Road Centre (properties east of Boonara Avenue)
2. Charing Cross Centre
3. Rose Bay North Centre
4. Rose Bay South Centre
5. North Bondi Centre
6. Blake Street Centre
7. Bronte Beach Centre
8. Macpherson Street Centre (properties west of 38-40 Macpherson Street, inclusive)
9. Curlewis Street Centre

There are two typical built forms for three storey Local Village Centres which are dependent on whether the property has access to a rear lane.

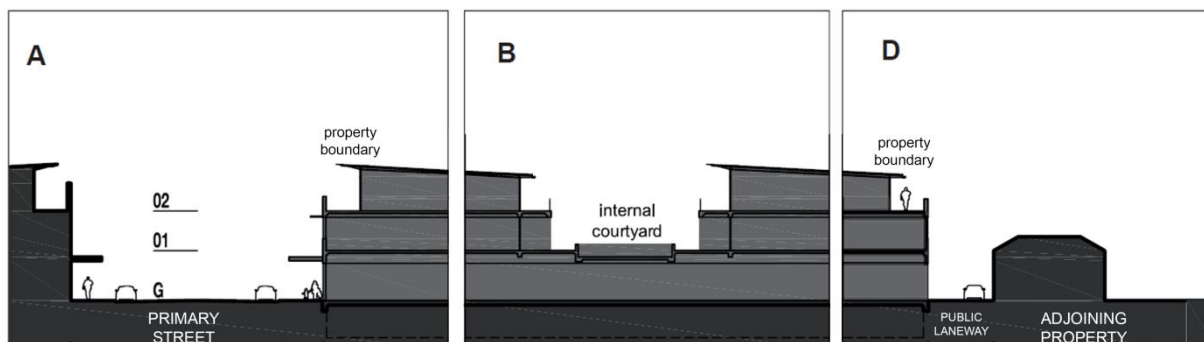
- (a) Properties without rear laneway: Control Diagram A, B and C.
- (b) Properties with rear laneway access: Control Diagrams A, B and D.

For applicable properties refer to the associated maps in Section 3.1 – Specific Controls.

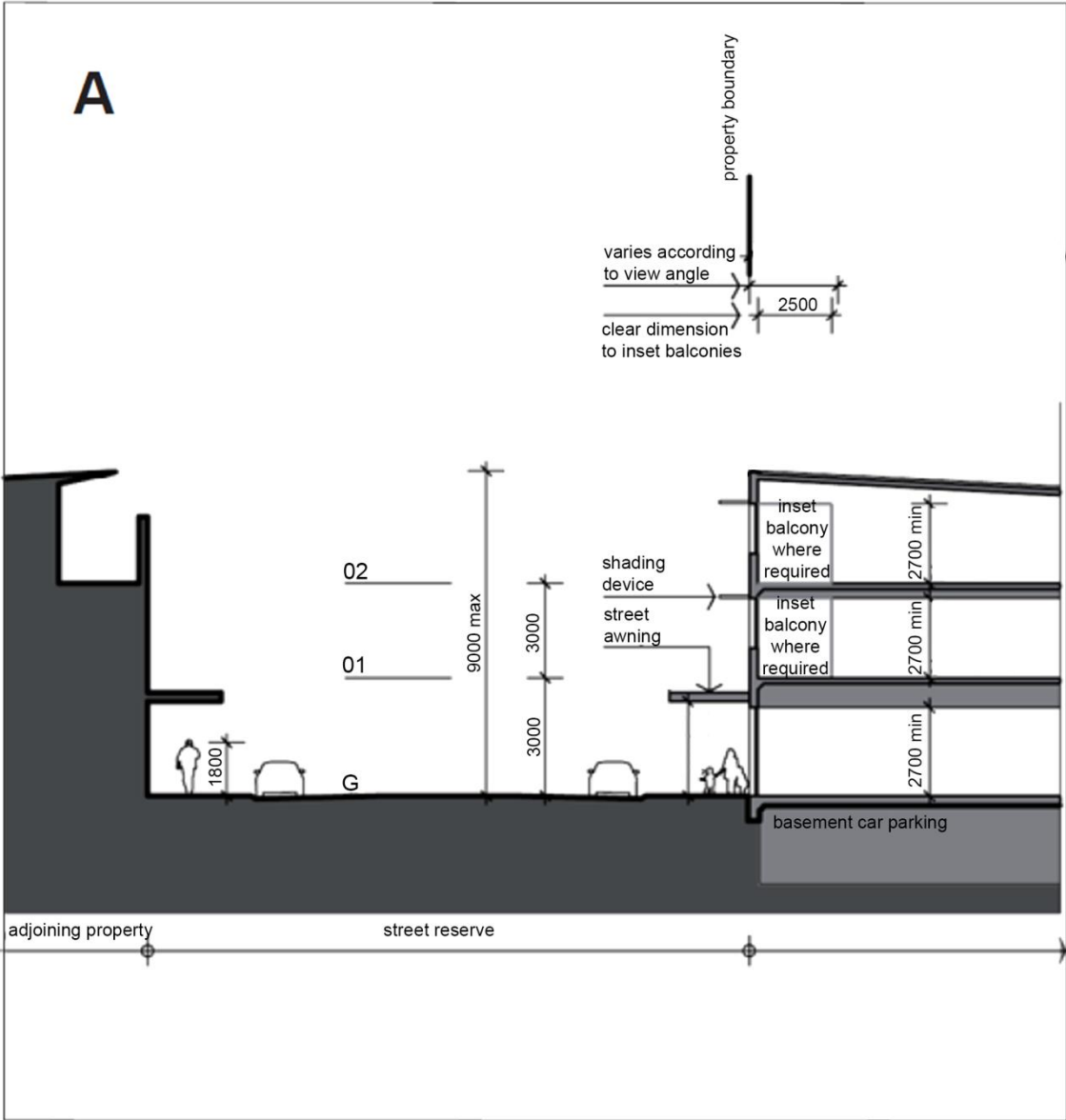
### Three (3) storey section without rear laneway



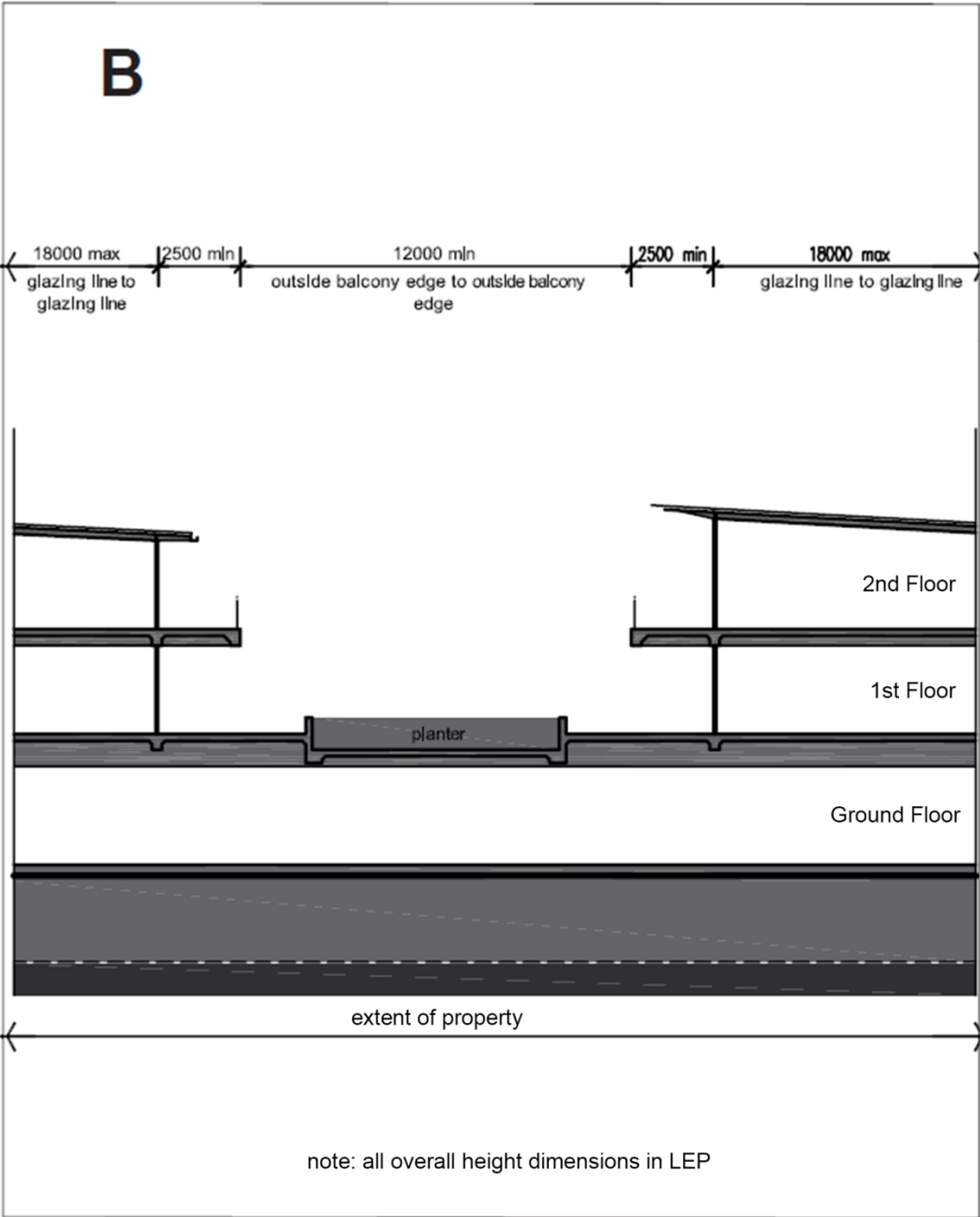
### Three (3) storey section with rear laneway



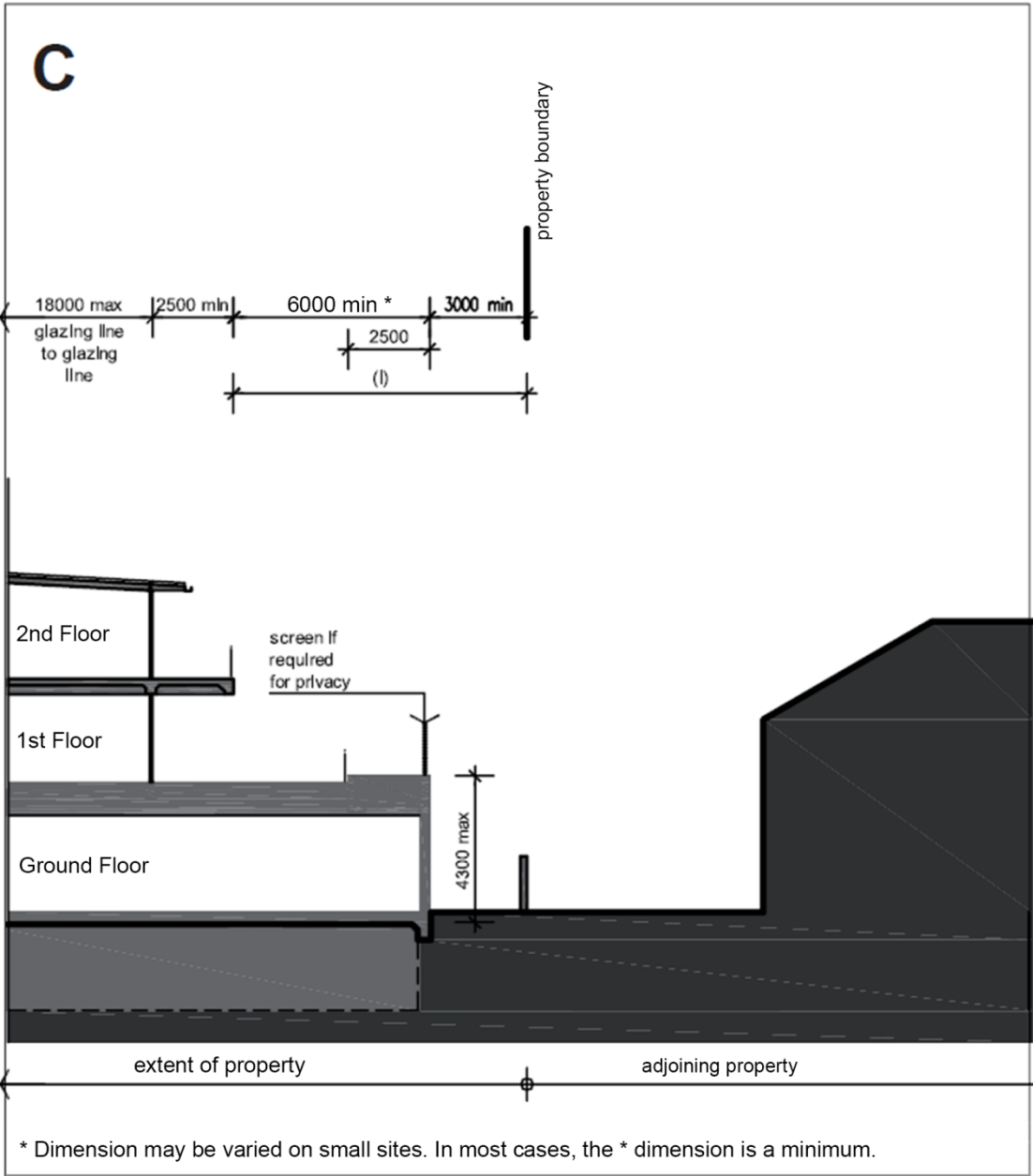
Three (3) storey detailed street interface and internal dimensions



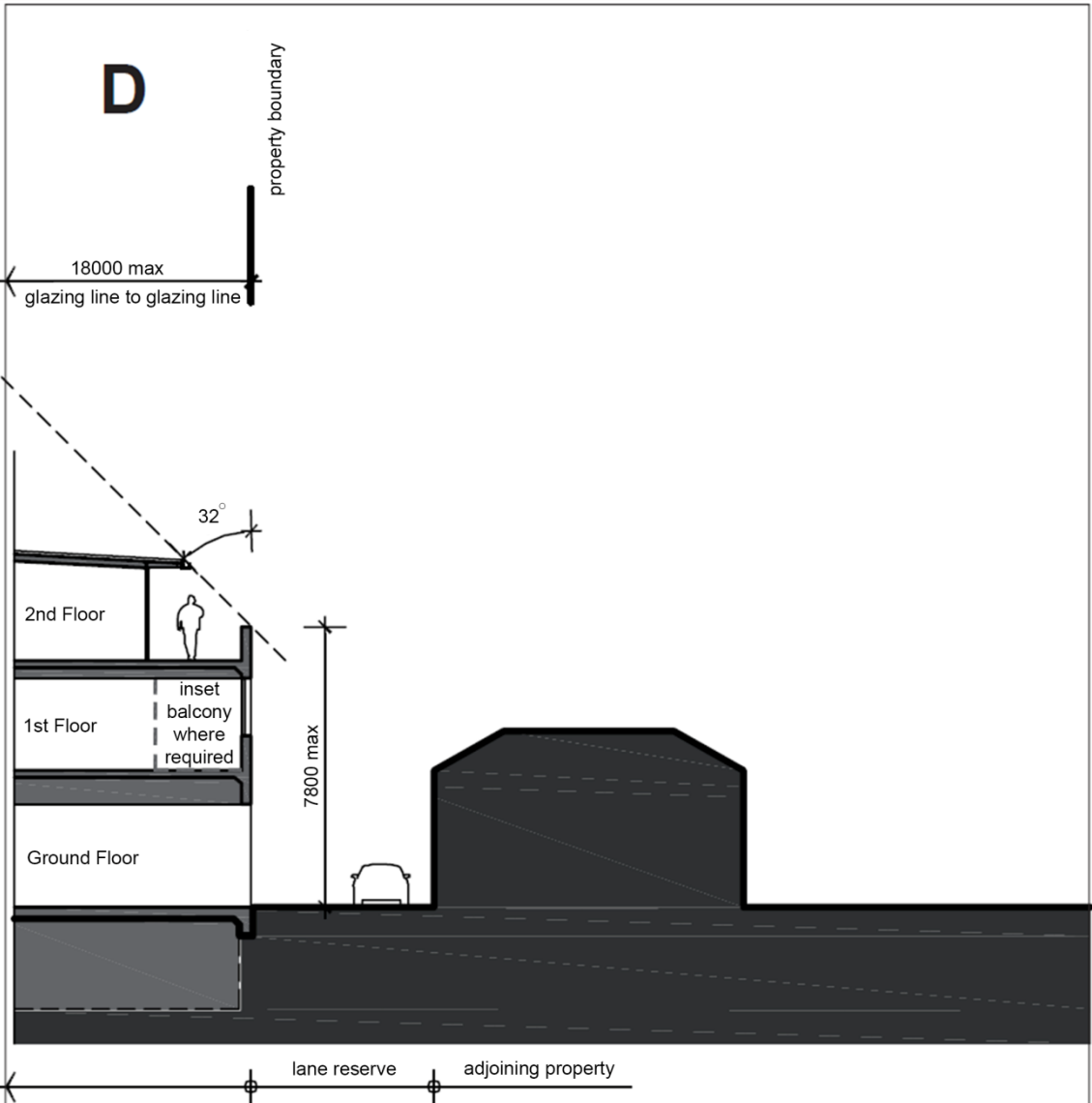
Three (3) storey detailed internal courtyard



Three (3) storey rear setback details without rear laneway



Three (3) storey rear setback details with rear laneway



## ANNEXURE E3-3 TYPICAL BUILT FORM FOR FOUR STOREY CENTRES

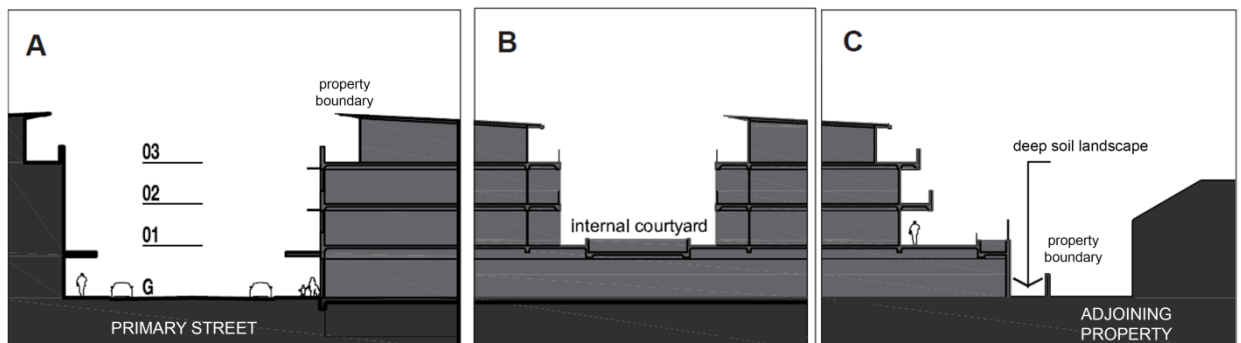
Annexure E3-3 applies to the following centres:

1. Bondi Beach Centre
2. Bondi Road Centre (properties west of Boonara Avenue)

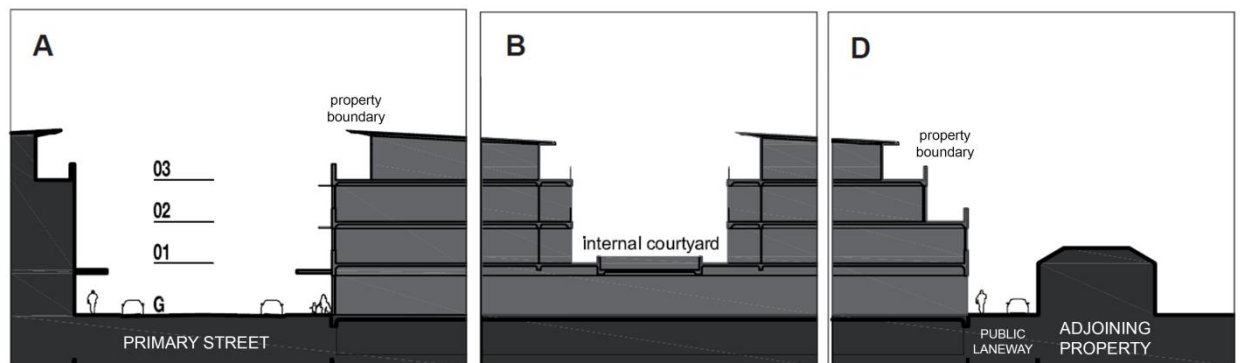
There are two typical built forms for four storey Local Village Centres which are dependent on whether a property has access to a rear lane.

1. Properties without rear laneway: Control Diagram A, B and C.
2. Properties with rear laneway access: Control Diagrams A, B and D.

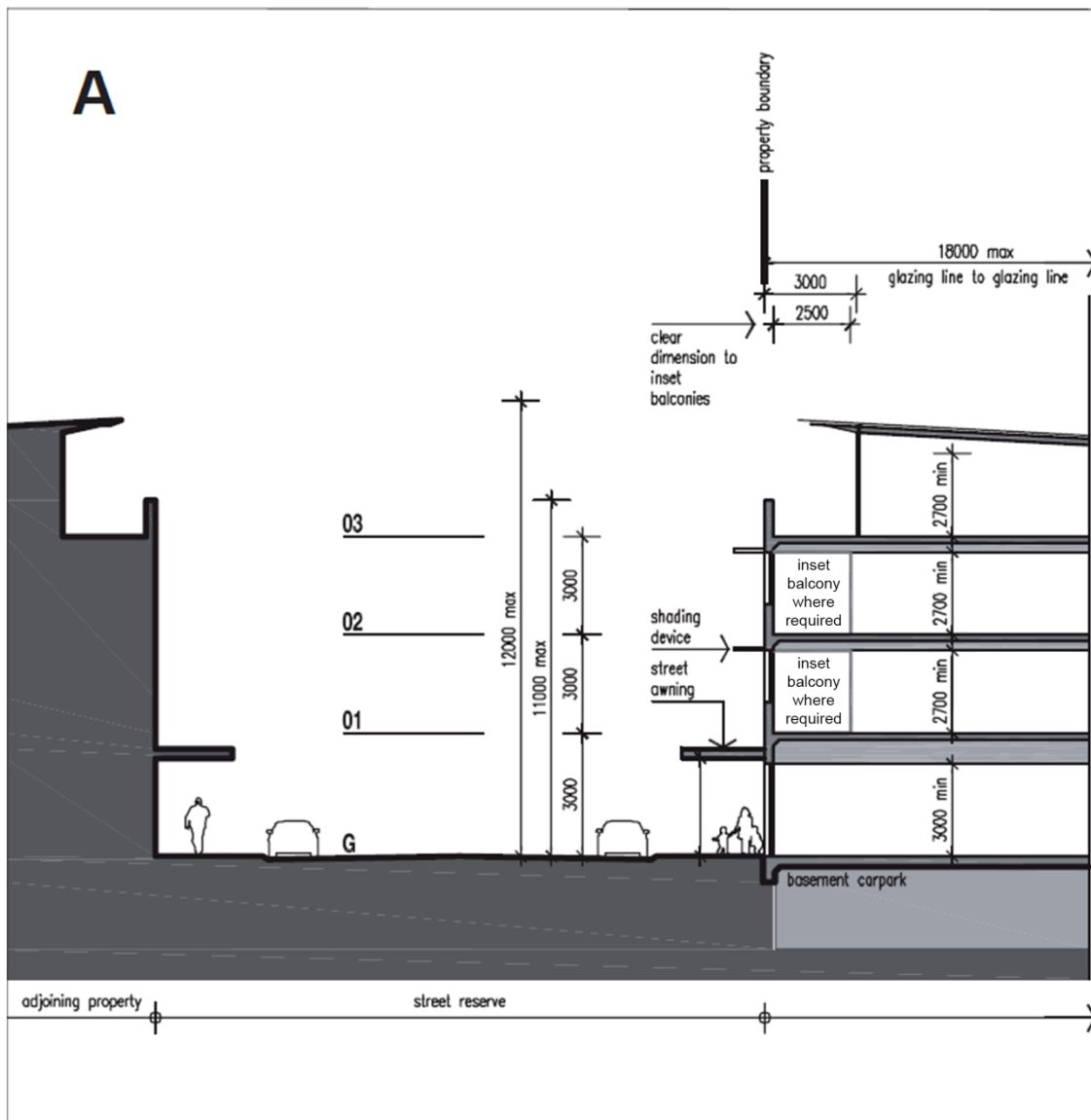
### Four (4) storey section without rear laneway



### Four (4) storey section with rear laneway

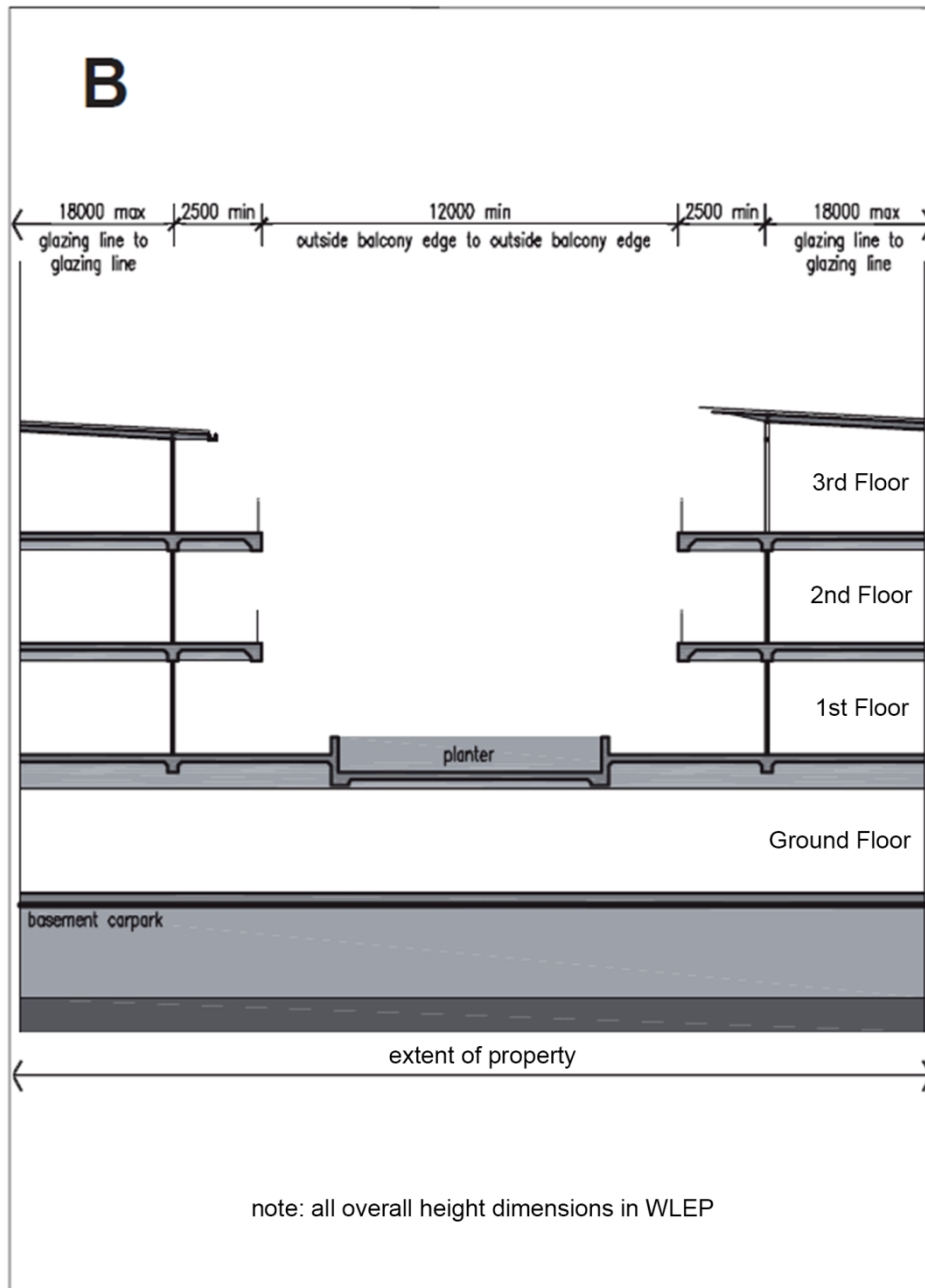


Four (4) storey street interface details and internal dimensions

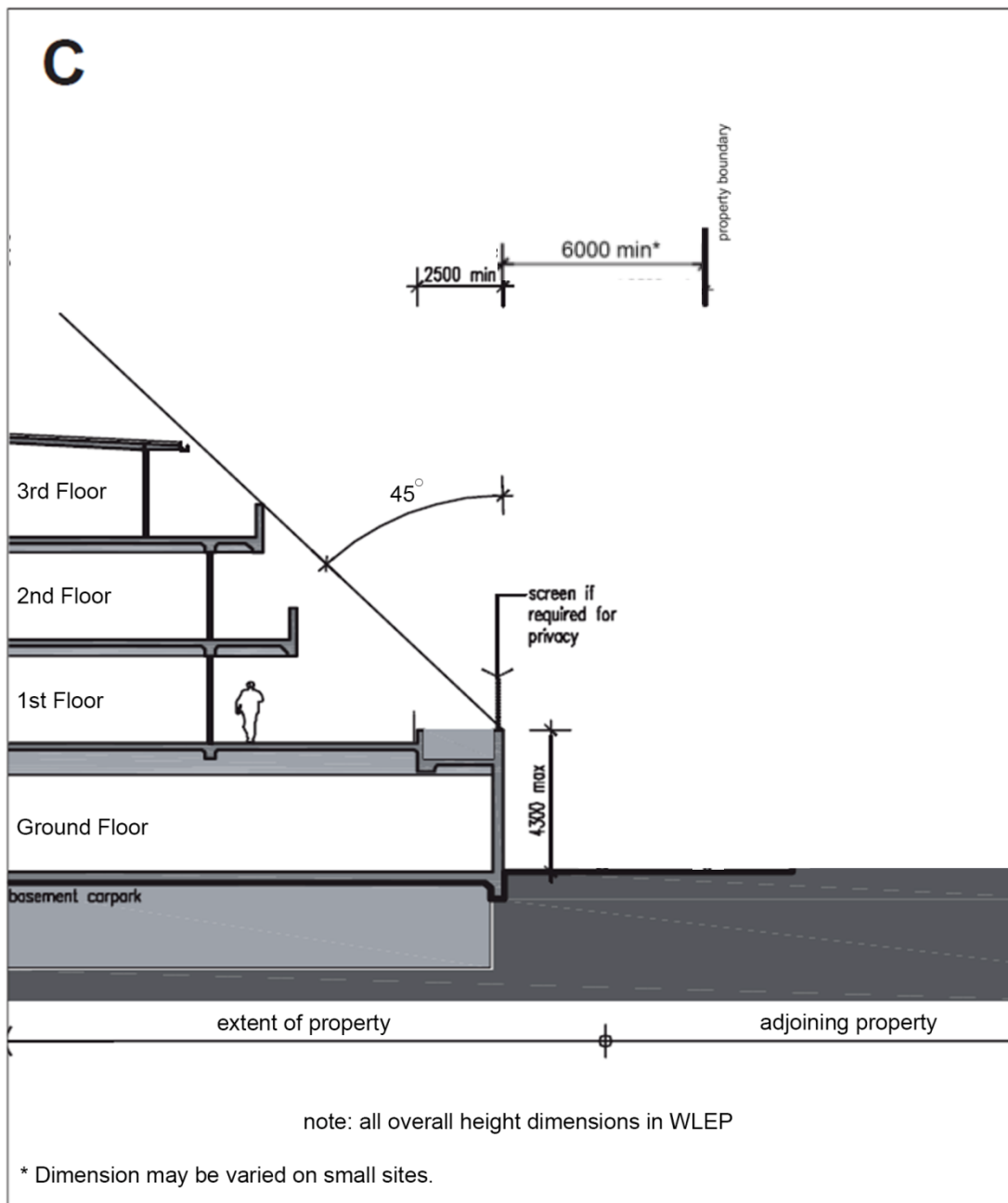




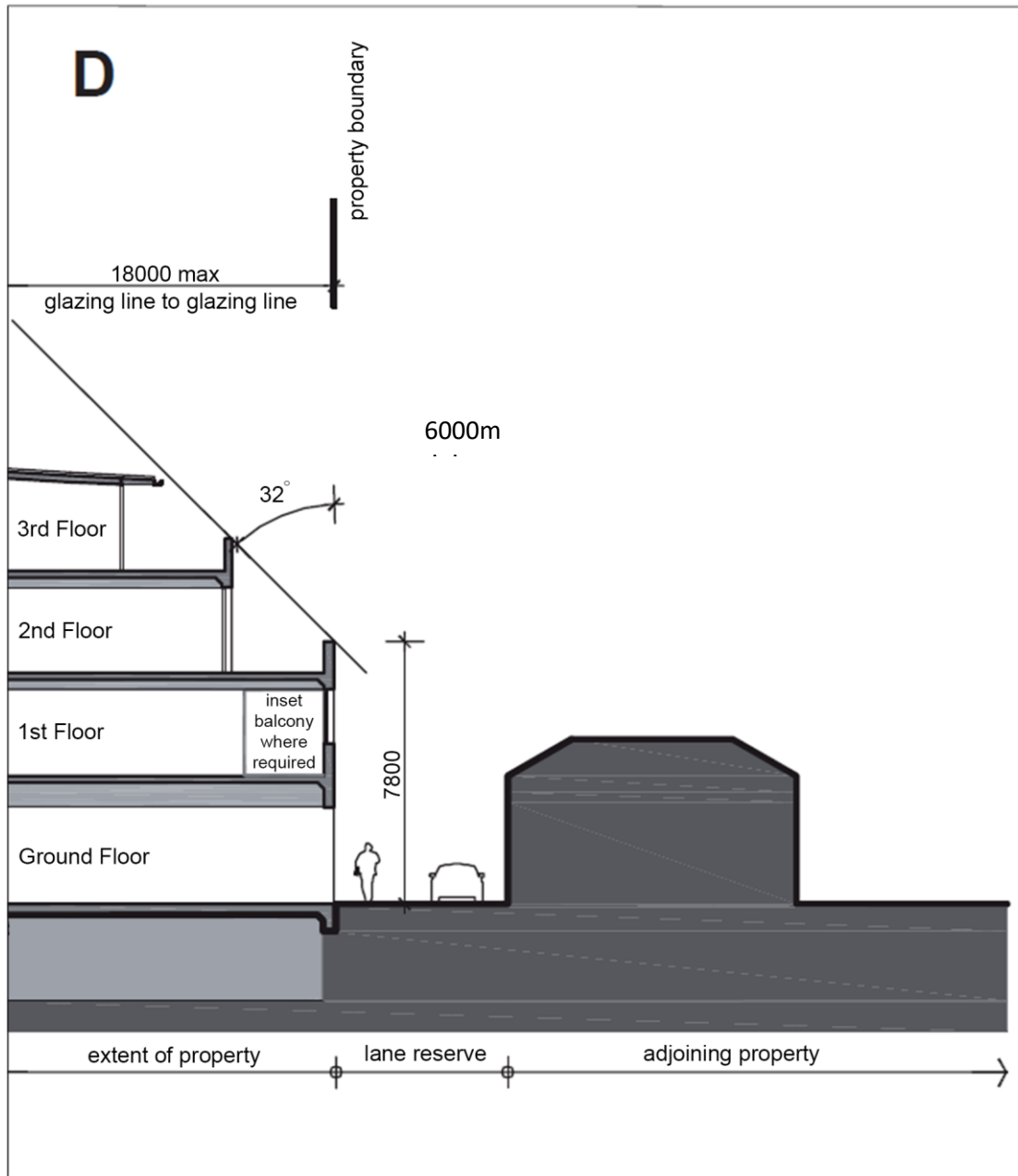
Four (4) storey internal courtyard details



Four (4) storey rear setback details without rear laneway.



Four (4) storey rear setback details with rear laneway



**ANNEXURE E7-1 – CONSERVATION MANAGEMENT PLAN 2017**

# Uniting (NSW) Waverley War Memorial Hospital Site

## Conservation Management Plan

Version 2.2

April 2017

Prepared for Uniting (NSW)  
by

HECTOR ABRAHAMS ARCHITECTS

### Version Control

Version	Authors	Date
Version 2.2	Hector Abrahams Architects	April 2017
Version 2.1	Hector Abrahams Architects	February 2017
Version 2 (DRAFT)	Hector Abrahams Architects	May 2016
Version 1	John Oultram Heritage & Design	March 2005

Uniting (NSW) Waverley War Memorial Hospital Site  
 Conservation Management Plan (April 2017)  
 Prepared for Uniting (NSW)  
 By Hector Abrahams Architect  
 Studio 402, Reid House,  
 75 King Street, Sydney NSW 2000

*Cover Photo and other recent photographs in this document: Hector Abrahams Architects*



## TABLE OF CONTENTS

<b>1. Executive Summary</b> .....	<b>1</b>
<b>2. Introduction</b> .....	<b>3</b>
2.1. Outline of tasks.....	3
2.2. Definition of the study area .....	3
2.3. Methodology .....	4
2.4. Limitations.....	5
2.5. Identification of authors.....	5
2.6. Acknowledgements.....	5
<b>3. Documentary Evidence/History</b> .....	<b>6</b>
3.1. History.....	6
<b>4. Physical Evidence</b> .....	<b>13</b>
4.1. Description of the site. ....	13
4.2. Analysis of Existing Fabric.....	14
<b>5. Assessment of Cultural Significance</b> .....	<b>16</b>
5.1. Comparative Analysis .....	16
5.2. Assessment of Significance .....	17
5.3. Statement of Significance .....	19
<b>6. Opportunities and Constraints</b> .....	<b>21</b>
6.1. Cultural Significance should be preserved.....	21
6.2. Opportunities for further revealing of significance .....	21
6.3. Opportunities for demonstrating significance.....	21
6.4. Dissemination of knowledge .....	22
6.5. The Requirements of Uniting (NSW).....	22
6.6. Statutory Heritage Listings .....	23
6.7. Non-Statutory Heritage Listings .....	24
<b>7. Conservation Policies</b> .....	<b>26</b>
7.1. Conservation Approach.....	26
7.2. Policies.....	28
<b>8. Appendix</b> .....	<b>31</b>
Detailed Account of the Development of the Estate .....	31

## 1. Executive Summary

This report is about the heritage significance of the War Memorial Hospital site in Waverley.

In Sections Three, Four and Five, a detailed examination of the site and its history is presented, and conclusions drawn to define the heritage significance of the site in this way-

*Donated to the Methodists by the Vickery family as a memorial to Ebenezer Vickery Jr, the place is an outstanding representative example of private philanthropy and the 20th century conversion of Victorian estates to institutional uses.*

*The War Memorial Hospital, established in 1922 by the Methodist Church as a memorial to the First World War, occupies the buildings and grounds of the former Edina estate, which is aesthetically and historically significant as a suburban Victorian estate that retains its spatial order, scale and planning, as well as four very good Victorian houses, three of which form a significant streetscape along a rare private streetscape. The Victorian landscape planning is overlaid by a 1920s landscape of significance in its own right, as are the 1930s hospital chapel and main wing.*

*The site's mansion tower and Norfolk Island pines have landscape urban significance as landmarks within the broader surrounding area.*

After an examination in Section Six of the opportunities and constraints that arise from this significance, and the needs of the owners, policies for conserving that significance are presented in Section seven. The policies address

- Conserving the single estate character and its main landscape spaces and landmark trees;
- Preserving the Victorian Buildings, Main Hospital Building and Chapel and the important garden spaces;
- Reconstruction of the main driveway sequence, or approximation thereof;
- Developing parts of the site to extend its historic use as a unified place of care.





## 2. Introduction

### 2.1. Outline of tasks

This plan provides a detailed analysis of the place and an assessment of the sites as a whole and its major significant elements. It also identifies the built elements, site features and landscape features on the site.

The history of the site is investigated from documentary sources. Then the cultural significance of the site is assessed and a statement of significance defined.

The implications of its significance, its statutory listings, and the owners' requirements are analysed, and in light of this, policies are developed for the conservation of that significance.

This report is a revision of the Conservation Management Plan and Development Strategy for the Waverley War Memorial Hospital prepared by John Oultram Heritage & Design in March 2005 (2005 CMP). For this revision

- The detailed historical account prepared for the 2005 CMP is reproduced in the Appendix. Additional photographic research has been undertaken for this revision, and four additional photographs are reproduced in the report;
- A new survey of the site has been done, to present current configurations, along with new diagrams to demonstrate site development that includes spaces between the buildings on the estate;
- A new Assessment and Statement of Significance has been prepared;
- Diagrams have been prepared to indicate in detail levels of Significance across the whole site;
- Formal policies have been formed based partly on a new statement of owner's needs.

### 2.2. Definition of the study area

The site is that of the Uniting Waverley War Memorial Hospital Site in Bronte Street Waverley, as shown in Figure 1. The real property descriptions are also shown on the plan.

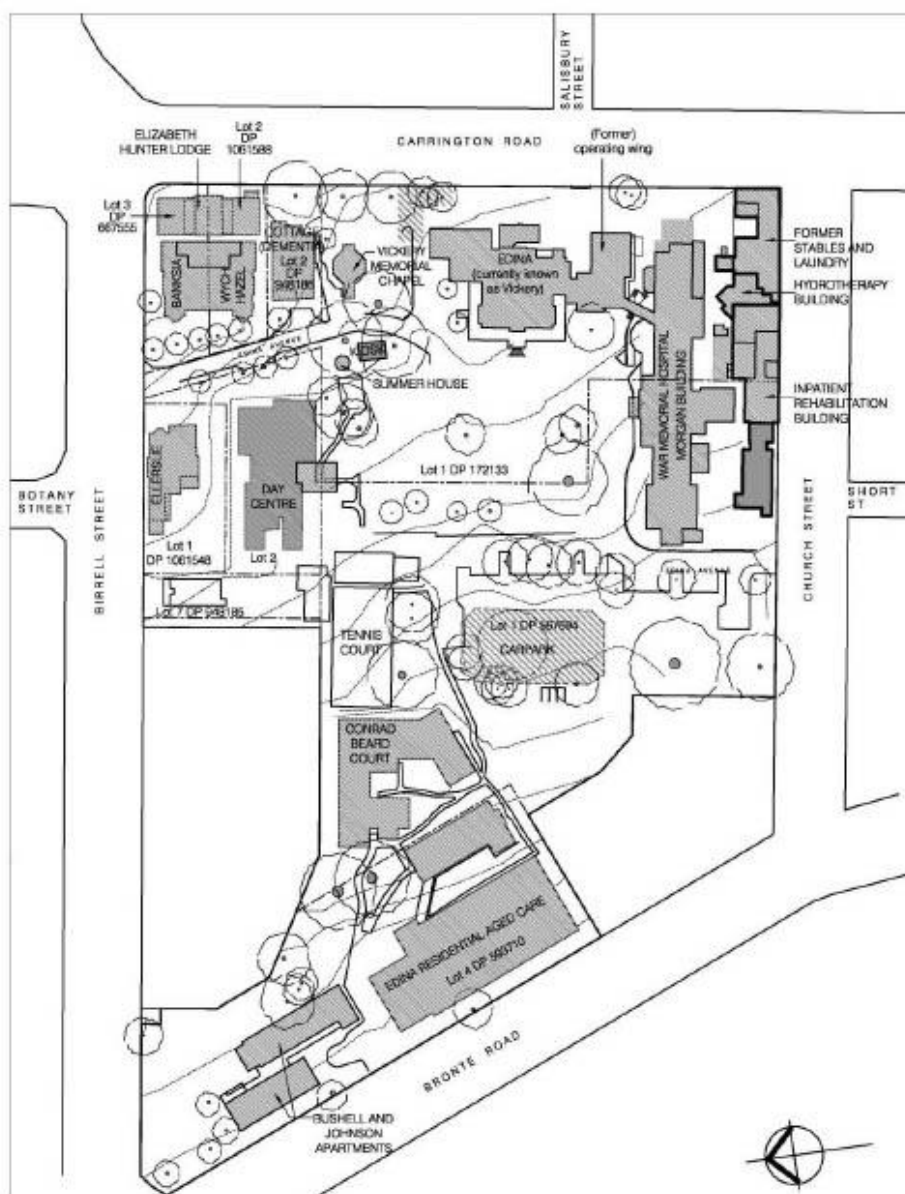


Figure 1: Site Location Plan for Uniting Waverley War Memorial Hospital Site. (Source: Hector Abrahams Architects.)

### 2.3. Methodology

The form and methodology of this report follows the general guidelines for conservation management plans outlined in J S Kerr, *The Conservation Plan*, The National Trust of Australia (NSW), sixth edition, 2004, the guidelines to the Australia ICOMOS Charter for Places of Cultural Significance (The Burra Charter), and the NSW Heritage Branch and Planning NSW's publication *Heritage Manual* (November 1996, as amended July 2002).



## 2.4. Limitations

This report addresses only the European cultural significance of the place.

This report does not address indigenous heritage significance, which can take the following forms:

- archaeology of indigenous pre-history
- post-contact history
- Present-day associations or spiritual attachments.

The report does not include analysis of the interiors of buildings, or their individual developmental history.

## 2.5. Identification of authors

The 2005 report was prepared by John Oultram and Susan O'Neill. The historic research was undertaken by Nicholas Jackson. Colleen Morris assessed the landscape, and Dominic Steel the archaeology of the site.

The history component (Section 3.1: History) of this revised report has been summarised from the 2005 report by the historian Meg Quinlisk. She also contributed to the assessment of significance and policy development. Hector Abrahams and Tonia Reed Abrahams prepared this report (Revised Version 2017), indicating where relevant text from the 2005 report has been used.

## 2.6. Acknowledgements

The authors acknowledge with thanks the assistance provided by

- Trent Wiggins and Fiona Logge at Uniting (NSW)
- Dr Alex Byrne, NSW State Librarian
- Michael Grave, architect, Cox Richardson Architects and Planners

### 3. Documentary Evidence/History

#### 3.1. History

*This history was written by Meg Quinlisk. The 2005 CMP contains a detailed account of the development of the estate, which can be found at Appendix 1*

The Waverley War Memorial Hospital is the result of the philanthropic benefaction of the Edina estate, made by the descendants of Ebenezer Vickery (1827-1906), who was a successful and influential Sydney merchant during the second half of the 19<sup>th</sup> century.

Vickery purchased the majority of the estate at Waverley in 1859. The property already contained a house known as Rockhampton, built about 1853. In 1874 and 1875, Vickery purchased two additional allotments of land contiguous with the Edina estate, thus returning the property to its originally-granted form of 1840: an 8-acre portion bounded by Birrell Street, Church Street, Carrington Road and Bronte Road. The mansion at the heart of the estate was constructed in 1884 by the builder William Leggoe of Paddington<sup>1</sup> probably to the design of Thomas Rowe. Rowe (1829-1899) was one of the most prominent architects in New South Wales in the later 19<sup>th</sup> century. He was a Methodist, and his offices were in Vickery's Chambers on Pitt Street. Rowe had previously designed business premises for Vickery, as well as a number of Methodist churches which were financed by Vickery.

Other buildings on the estate completed by 1888 include the stables and coach house and a gate lodge. A private drive extended off Birrell Street and passed between a semi-detached pair of villas known as Wytchazel and Banksia (built c.1882 to accommodate Vickery's sons<sup>2</sup>), and the house known as Ellerslie (housing a Vickery son-in-law; built c.1882; possibly contains remnants of the 1853 house Rockhampton). Photographs from this period show that the estate was planned along the lines of the picturesque aesthetic: the principle houses sat on grassed terraces raised above a formal lawn and pleasure garden laid out with paths and decorated with statuary and a pond. Thick plantings of trees and bushes created a backdrop 'wilderness' setting in views of the house obtained as a visitor approached via the formal driveway from the northwestern corner of the estate (at the intersection of Birrell Street and Bronte Road).

<sup>1</sup> 'Advertising', *Sydney Morning Herald*, 17 January 1884, p. 13.

<sup>2</sup> Thomas Rowe called for tenders for the erection of two semi-detached villas at Waverley in November 1881; 'Advertising', *Sydney Morning Herald* 24 November 1881, p. 11.



Figure 2: View towards Edina showing formalised pathway and pond surrounded by camellias and roses, c.1894. The integrated landscape can be clearly seen, with the pond being the vehicular "drop-off" point for the house. (Source: Vickery Album, SLNSW, PXA 1742)



Figure 3: The open character of the landscape close to the house with tennis lawn in front of Edina, c.1894. (Source: Vickery Album, SLNSW, PXA 1742)





Figure 4: View towards Edina from the service paddocks, now the site of the current War Memorial Hospital building. Note the already mature Norfolk Island Pines. (Source: Vickery Album, SLNSW, PXA 1742)



Figure 5: Banksia and Wytchazel behind an original iron palisade fence, reinforcing the "private street" nature of this entry to the site. (Source: Vickery Album, SLNSW, PXA 1742)

Following Ebenezer Vickery's death in 1906, his son Ebenezer Vickery Junior inherited the estate. He subdivided it between various family members, but retained the bulk of the estate himself. He lived at Edina until his death in 1915. He was survived by his wife, Ella Jane Vickery, who remained at Edina. A diagram showing the features of the estate at the end of this period is shown at Figure 6.

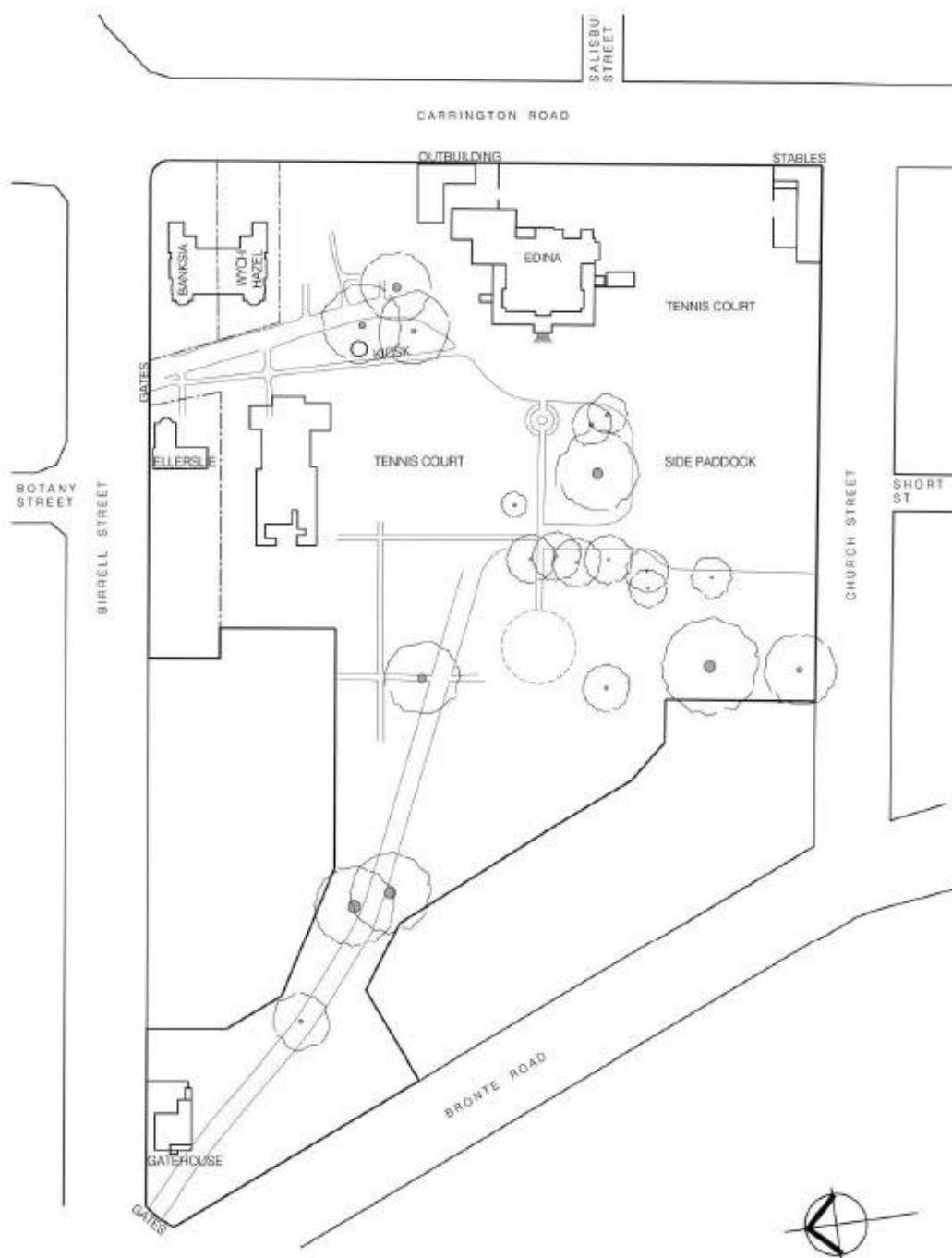


Figure 6: Features of the Edina estate. (Source: Hector Abrahams Architects)



At the end of the First World War, the Methodist Conference for NSW agreed to found a hospital as a war memorial. On Anzac Day 1919, Ellen Jane Vickery offered Edina – including the main house, front lawn, top tennis court, glass house, stables and men's quarters – to the Methodist Church for use as a hospital, in memory of her late husband Ebenezer Vickery, Jr. The terms of her gift required the Methodists to purchase the adjoining 3 acres of land containing the houses Wytchazel, Banksia and Ellerslie, and six cottages.

The Church accepted the terms of the offer in June 1919. Ellerslie was converted for use as an isolation ward for 19 patients, and became the first part of the hospital to be opened, in February 1921. The formal handover of the title deeds took place at the official opening of the War Memorial Hospital by the Governor Sir W. Davidson on Remembrance Day, 1922. The hospital operated under the *Private Hospitals Act 1908* and was overseen by a board which included representatives of the Vickery family.

Upon opening, the hospital contained 92 beds in Edina and Ellerslie. Banksia and Wytchazel provided accommodation for nurses. From its opening, the hospital was accredited as a training hospital for general nurses. Over the ensuing years, developments in medical practice saw the following changes and additions to the former Edina estate:

- 1923 New wing added to Edina for operating theatre
- 1933 Vickery Memorial Chapel was built with a bequest by the Vickery family as a memorial to Ellen Jane Vickery, who died in 1932.
- 1933 Coach house and stables converted to laundry.
- 1935 New hospital block, designed by Noel W. McPherson was opened by the NSW Premier. It functioned as a maternity block.
- 1952 Elizabeth Hunter Nurses Home was purpose-built for nurses' accommodation.
- 1963 Construction of Eastern Suburbs Senior Citizens Welfare Centre on Bronte Road.

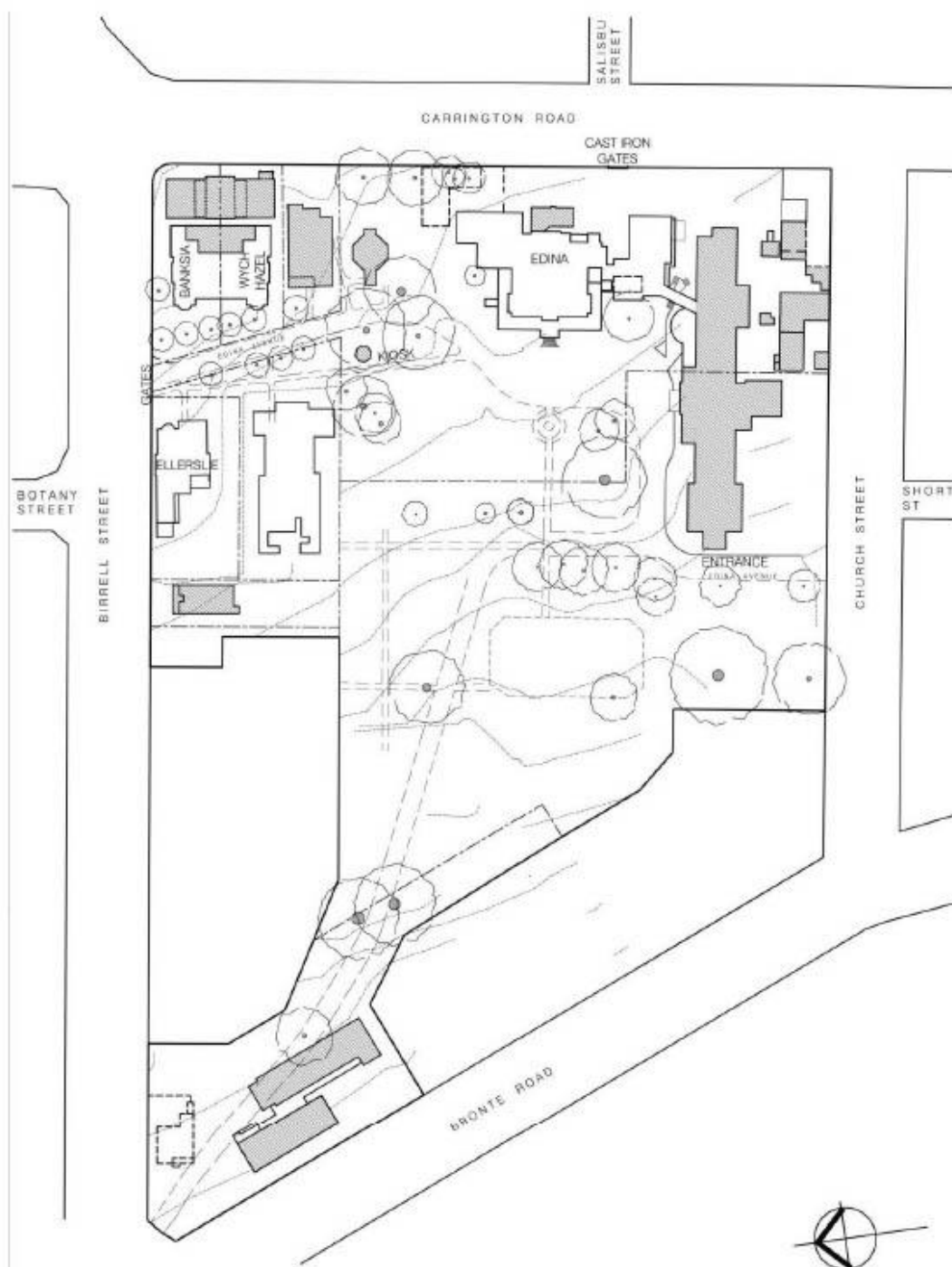


Figure 7: Major features of the hospital period, 1919-1963. (Source: Hector Abrahams Architects)

From 1969, the hospital became part of the public hospital system. This brought in public funding, but over time it changed the nature of services provided. The nurses' training ceased. Maternity services at the hospital closed in 1979. Since 1982, the hospital's focus has been geriatric rehabilitation and assessment services. Between 1988 and 1991, additional land was

purchased and the aged self-care complex was completed. Aged care continues to be the War Memorial Hospital's primary area of practice, as well as a range of outpatient services.

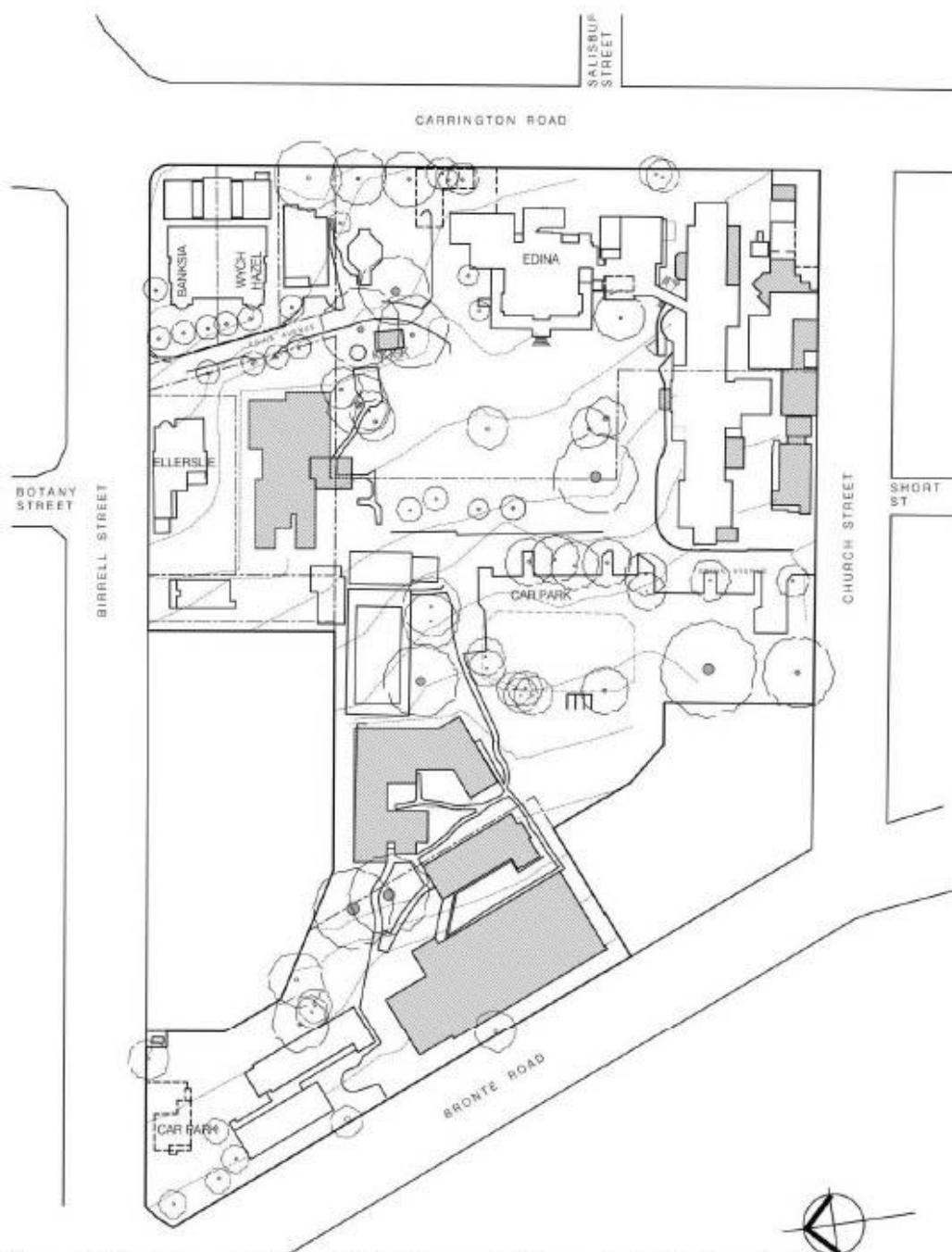


Figure 8: Major features of the hospital 1969 to present. (Source: Hector Abrahams Architects)



## 4. Physical Evidence

### 4.1. Description of the site.

*This description is from the 2005 CMP. References to figures have been brought up to date.*

The War Memorial Hospital is situated on a ridge of the highest point in the eastern suburbs. The site is bounded by Birrell Street, Carrington Road, Church Street and Bronte Road. Portions of this block, including a strip along Birrell Street and the corner site on Bronte Road and Church Street are privately owned. A number of the semi-detached houses along Birrell Street have been purchased by the hospital over the years.

The site contains a very fine group of high Victorian buildings, of which the most elaborate house in the area is Edina (Vickery Building), a large two storey Victorian house with a tower. The house has an extant stable block to the south west corner of the site that has now been converted to workshops. The site contains extensive remains of the former Victorian garden and trees, particularly in the terraced lawns near Edina. It also retains pathways, steps and drives from that time.

There is also a group of three, two storey, boom period, Italianate/Gothic houses towards Birrell Street that flank an entry drive, Edina Avenue, leading from the street to the main house.

There are two smaller houses in the Federation/Inter war style along Edina Drive that have been converted for hospital use.

The grounds have been developed for hospital use, and latterly aged care and rehabilitation services and contain a large number of buildings built for these services. Most prominent is the Morgan Wing, a long, three storey Mediterranean style building to the east of Edina with a four storey tower flanked by a decorative terracotta tile roof.

The site slopes east to west. The lower portion of the site has been heavily redeveloped for aged care accommodation. There are a number of temporary modern sheds and portacabins around the site and a network of drive and parking areas.

Two sections of ornate, original gates and fence sections survive on Carrington Road behind the Vickery Building and on the corner of Birrell Street and Bronte Road. There is a small section of low sandstone fence to Bronte Road and a higher section along church road that is in part a retaining wall and is incorporated into some of the buildings along this boundary. The site contains extensive landscaping and planting. This has been identified in Figure 9 below.

The site has much of its earlier Victoria garden layout and plantings, though this has been overlaid with plantings from each era of development. The upper portion of the site at Edina is laid out with terraced lawns to the front of the house with a turning circle and paths on the central axis of the house. The lawns are planted with mature Figs, two very tall Norfolk Island Pines and later Phoenix Palms. The Norfolk Island Pines are visible from many aspects around the site and beyond.

There are some interesting specimen trees indigenous to Queensland that may have been selected plantings in the lower garden (Queensland Firewheel tree, *Podocarpus* sp.)(no.14 in figure 9).

To the north is a drive and pathway that form the main entrance from Birrell Street that are lined with Phoenix palms and later, low planting.

There are boundary tree plantings to the rear of Edina along Carrington Street but this area is largely hardstanding.

The lower portion of the site has been redeveloped for buildings and pathways though there are remnant Victorian plantings along the lower terrace bank and in the section of the site toward the ornate entry gates to Bronte Road. There is a large area of lawn towards the rear of the houses along Bronte Road.

#### **4.1.1. Site Features**

The site contains extensive remains of the original development of the site and many later site features.

The upper portion of the site contains many elements from the Victorian garden including a set of statues on pedestals that appear to represent the arts and industry. The form of the original turning circle is in place, though resurfaced, and the original paths and planters have rolled and roped edges in places.

## **4.2. Analysis of Existing Fabric**

The physical fabric of the estate, its principle views and spaces have been surveyed and recorded on the plan Figure 9.

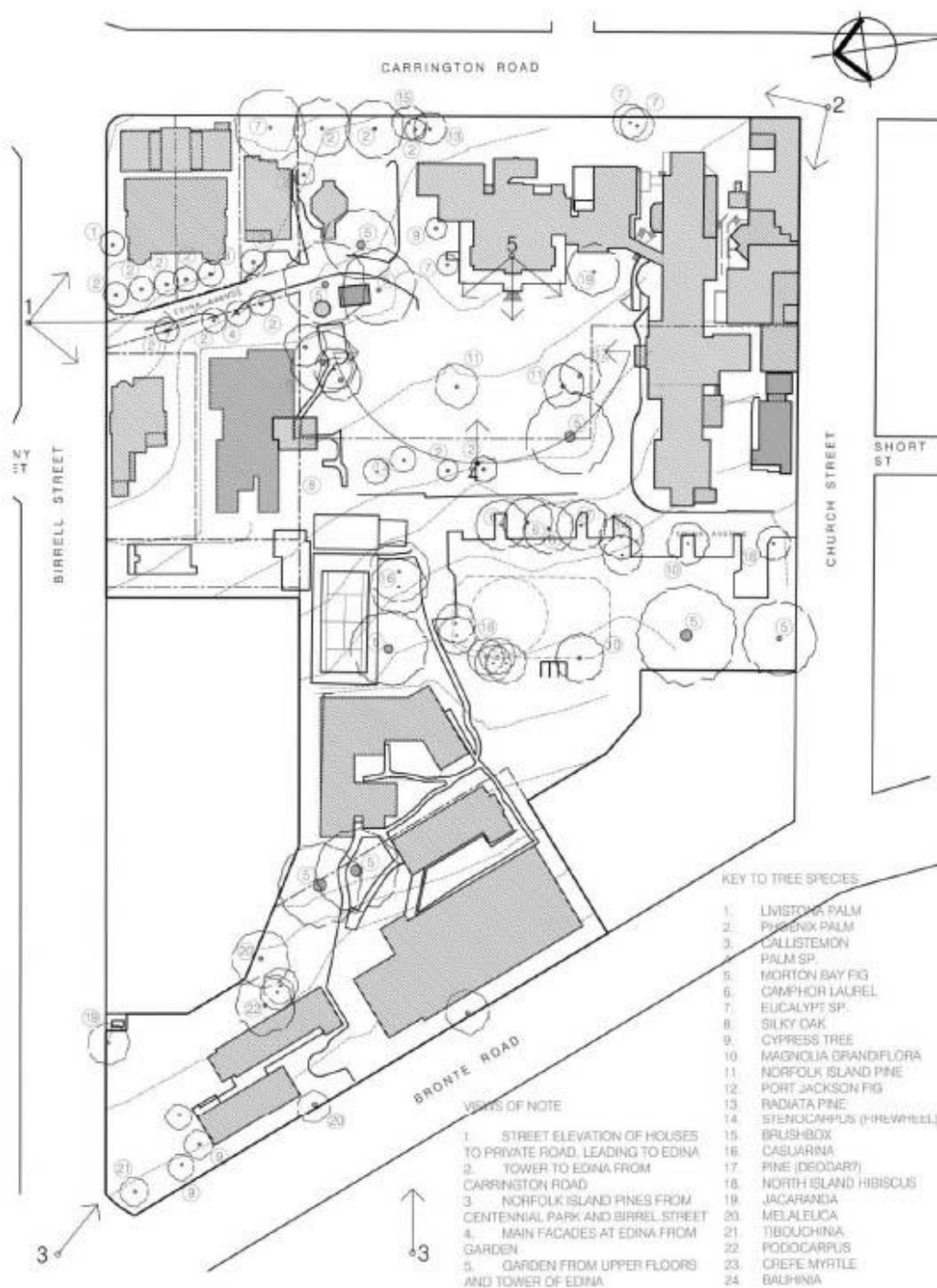


Figure 9: Principle views and spaces of the site. (Source: Hector Abrahams Architects)



## 5. Assessment of Cultural Significance

### 5.1. Comparative Analysis

The War Memorial Hospital is one of a set of Victorian suburban estates in Sydney that survive to the present day with their Victorian-period spatial integrity intact. Several of these have become institutions through philanthropic donations which, in some cases, ensured their survival. While some continue to be occupied as private residences (e.g., Swifts, Fairwater, Bronte House), many others have become schools, and several have become hospitals.

This group of surviving Victorian suburban estates includes the following major examples:

- Cardinal's Palace, Manly (now part of St Paul' Catholic College)
- Gorton, Ashfield (now The Infants Home)
- Yasmar, Haberfield ( now a juvenile justice centre)
- Mount Royal, Strathfield ( now a campus of the Australian Catholic University)
- Aston Lodge, Randwick (now the Emanuel School)
- Aeolla, Randwick ( now Brigidine College)
- Graythwaite ,North Sydney (now part of Shore School)
- Greenoakes, Darling Point (recently ceased use as Residence of the Archbishop of Sydney)



## 5.2. Assessment of Significance

Having arrived at an understanding of the place through analysis of the relevant documentary records as well as the physical fabric of the place, the following assessment of the cultural significance of the site is made in accordance with the New South Wales State Heritage Criteria.

*Criterion (a): An item is important in the course or pattern of NSW's (or the local area's) cultural or natural history.*

The Waverley Memorial Hospital is historically significant as an example of planned benefaction, a form of philanthropy that saw 19<sup>th</sup> century suburban villas, mansions and estates donated in the early 20<sup>th</sup> century for use by social institutions for the public good.

The Methodist Church's establishment of a hospital as a memorial to the First World War is a prominent example of the expressions of commemoration which prevailed in Australian public and community building projects in the 1920s.

The site and 19<sup>th</sup> century residential buildings at the War Memorial Hospital reflect the history of subdivision and residential development of the area, in particular the construction of mansions within landscaped grounds by the wealthy merchant classes, buoyed by the stable economic conditions of the 1870s and 1880s.

The ongoing use since 1922 as a fully-equipped medical hospital offering nurses' training is of historical significance in the evolution of health care and services in suburban Sydney.

*Criterion (b): An item has strong or special association with the life or works of a person, or a group of persons, of importance in NSW's (or the local area's) cultural or natural history.*

The Edina estate is closely associated with the Vickery family, the prominent 19<sup>th</sup> century Sydney merchants and philanthropists who supported many works by the Methodist Church. The family's donation of the estate to the Methodist Church was made as a memorial to Ebenezer Vickery Jr.

As one of the most ambitious and substantial works ever carried out by the Methodist Church in NSW, the War Memorial Hospital has a strong and significant historical association with the Methodist and later with the Uniting Church.

*Criterion (c): An item is important in demonstrating aesthetic characteristics and/or a high degree of creative or technical achievement in NSW (or the local area).*

The War Memorial Hospital site is one of the largest remaining suburban Victorian spaces in eastern Sydney; its overall spatial order is still discernible through the site's topography, trees, scale and arrangement of buildings. It contains Edina, which is a very good and highly intact example of a Victorian mansion, which is a showpiece of Victorian architectural technology (vaulted and concreted verandah construction, cast ironwork, internal stairs). The three large Victorian houses (Ella, Banksia, Wytchazel) built for family members, designed as a group and distinctively located along a private street, form a rare and very good example of a Victorian streetscape to two streets: the private street and Birrell Street.



The landscape design is significant as a highly representative example of Victorian estate planning, including the remnant statuary, tree species, fences and gates. The picturesque character of this Victorian landscape is overlaid by 1920s hospital-period landscaping which is of aesthetic and stylistic significance in its own right. The Norfolk Island pines within the lawn are aesthetically significant as landmark trees visible from as far away as Centennial Park. The tower of Edina, visible from the surrounding streets and along the length of Birrell Street, is of similar landmark value.

Some of the 20<sup>th</sup> century hospital buildings are of aesthetic significance in their own right. The 1935 wing is stylistically rare example of European expressionism, and is sensitive to Edina in its siting and scale. The chapel is a fine and original work of chapel architecture and rare for its time.

*Criterion (d): An item has strong or special association with a particular community or cultural group in NSW (or the local area) for social, cultural or spiritual reasons.*

The War Memorial Hospital is of some social significance for the high esteem the local community have held for it over the 20<sup>th</sup> century. People who have had some contact with the hospital, including people who were born there during its time as a maternity hospital, and nurses who trained there, hold it in high regard. There are several expressions of gratitude to the hospital by local community groups located within the hospital, and it continues to be a place of memorial, with buildings, wings and rooms given names in honour of individuals.

*Criterion (e): An item has potential to yield information that will contribute to an understanding of NSW's (or the local area's) cultural or natural history.*

The site has low archaeological potential; but within the buildings there is some research potential to discover the earlier forms of the Victorian houses.

*Criterion (f): An item possesses uncommon, rare or endangered aspects of NSW's (or the local area's) cultural or natural history.*

As discussed above, the War Memorial Hospital contains a rare example of European expressionism (1935 main wing) and a 1930s chapel which is rare for its time. As well, the Victorian streetscape of the private street addressed by three Victorian houses built as a set is significant for its rarity. The estate is one of a very small number of Victorian Sydney suburban estates to survive with its spatial order and 19<sup>th</sup> century planning intact.

*Criterion (g): An item is important in demonstrating the principal characteristics of a class of NSW's (or the local area's) cultural or natural places; or cultural or natural environments.*

As discussed above, the War Memorial Hospital is an excellent representative example of the philanthropic conversion of a 19<sup>th</sup> century mansion estate to a community use. The mansion itself is a very good and highly intact example of its type. The establishment of the hospital as a memorial to the First World War is a very good and substantial example of commemorative projects undertaken by private and public organisations in the 1920s.

### 5.3. Statement of Significance

Donated to the Methodists by the Vickery family as a memorial to Ebenezer Vickery Jr, the place is an outstanding representative example of private philanthropy and the 20th century conversion of Victorian estates to institutional uses.

The War Memorial Hospital, established in 1922 by the Methodist Church as a memorial to the First World War, occupies the buildings and grounds of the former Edina estate, which is aesthetically and historically significant as a suburban Victorian estate that retains its spatial order, scale and planning, as well as four very good Victorian houses, three of which form a significant streetscape along a rare private streetscape. The Victorian landscape planning is overlaid by a 1920s landscape of significance in its own right, as are the 1930s hospital chapel and main wing.

The site's mansion tower and Norfolk Island pines have landscape urban significance as landmarks within the broader surrounding area.





Figure 10: Ranking of fabric, spaces and views. (Source: Hector Abrahams Architects)



## 6. Opportunities and Constraints

This section presents information and discussion of issues that bear on the development of policies to conserve the cultural significance of the site.

The section begins with the implications of cultural significance itself, then follows the requirements of Uniting (NSW) and, finally, external statutory requirements.

### 6.1. Cultural Significance should be preserved

- The form, spaces and uses of the site that demonstrate its historical significance as an outstanding example of private philanthropy and its conversion by the Methodist Church to a war memorial hospital should be preserved and not obscured.
- The aspects of the site that are of aesthetic significance should be preserved. These are its intact spatial order, scale and planning of the estate, its four very good Victorian houses and stables, private streetscape, Victorian and 1920s landscape planting and features, 1930s hospital and chapel.
- The mansion tower and Norfolk Island Pines should be preserved as landmarks in the surrounding areas.

### 6.2. Opportunities for further revealing of significance

Where the significance of the site is obscured it should be revealed should the opportunity arise. Not all opportunities will necessarily be achievable or desirable. The major opportunities are as follows

- Removal of glass portico to reveal front entrance of 1935 Hospital
- Replacement of concrete driveways with more sympathetic material
- Reconstruction of grass bank to western side of Edina

Further opportunities exist in regard to details of the exterior and interior of the four Victorian houses, stables, summerhouse, and War Memorial Hospital and Chapel. These structures should be studied in more detail.

### 6.3. Opportunities for demonstrating significance

Opportunities exist to demonstrate or interpret the cultural significance of the site.

- Recreation of the original driveway path, in a manner similar to the original path (this would require the removal of buildings);
- Reconstruction of lower garden area (currently a carpark) to a garden area;
- Planting of trees which are missing from north west corner of the upper garden;
- Construction of a built form to close north end of service space behind Edina (where a Victorian outbuilding formerly stood);

- Construction of some built or garden form on site of original gatehouse (to mark entrance);

and more generally, and perhaps importantly

- Develop the site with an appreciation of its identity as a single planned estate;
- Develop the site with an appreciation of the spatial order of the estate, which is contiguous over all of its history to date.

Again, further opportunities exist in regard to details of the exterior and interior of the four Victorian houses, stables, summerhouse, and War Memorial Hospital and Chapel. These structures should be studied in more detail.

#### 6.4. Dissemination of knowledge

Opportunities exist to foster an appreciation of the significance of the site,

- Through composing written histories;
- By collecting historic information and material formally in an archive;
- By promoting more research into the site and its history.

#### 6.5. The Requirements of Uniting (NSW)

Uniting (NSW) wishes to provide a long term planned framework for the site in line with its broader mission and vision. The vision for the campus is "to be a restorative place; a village that is accessible to the broader community".

The intention is that the campus will be planned to include a residential aged care facility (RAC), a Third Schedule Hospital under the Health Services Act 1997, a range of community services, independent living accommodation, childcare and upgraded and augmented existing services.

## 6.6. Statutory Heritage Listings

### 6.6.1. Local Environment Plan (LEP)

The site is entered on the Waverley Local Environmental Plan 2012 - Schedule 5 Environmental heritage as follows:

Locality	Item name	Address	Property description	Significance	Item no
Waverley	War Memorial Hospital— landscape	Birrell and Church Street and Carrington Road	Lot 2, DP 1061588; Lot 1, DP 567694; Lot 7, DP 948185; Lot B, DP 317831; Lot 1, DP 172133; Lot 3, DP 667555; Lots 1 and 2, DP 1061548; Lot 1, DP 948186	State	1519
Waverley	War Memorial Hospital, Late Victorian buildings and former stables	125 Birrell Street	Lot 2, DP 1061588; Lot 1, DP 567694; Lot 7, DP 948185; Lot B, DP 317831; Lot 1, DP 172133; Lot 3, DP 667555; Lots 1 and 2, DP 1061548; Lot 1, DP 948186	Local	1449
Waverley	Federation style detached residences	2–8 Church Street	Lots 1 and 2, DP 630460; Lot 1, DP 167332; Lots 1, 2 and 3, DP 1098550	Local	1473

### 6.6.2. State Heritage Register, NSW Heritage Council

Neither the site nor any of its buildings are currently listed on the State Heritage Register. It is worth noting however that the LEP listing for the War Memorial Hospital Grounds notes the site is of State Significance.

### 6.6.3. Implications of Statutory Heritage Listings for the site

The listings provide recognition of the cultural significance of site in the planning system of New South Wales. The recognition means that retention of cultural significance is one of the criteria for assessment of any application for consent for works within the site and adjacent to the site. The planning system employs standard methodologies for assessing impact of developments on cultural significance.

## 6.7. Non-Statutory Heritage Listings

### 6.7.1. Australian Heritage Commission

The subject property is listed on the Register of the National Estate (002469) both as a group and the individual buildings including the main building Edina (Vickery Building) and the two houses, Banksia and Wytchazel.

### 6.7.2. National Trust of Australia (New South Wales)

The site is entered on the National Trust Register in the following way:

Locality	Item name	Address	Listing ID
Waverley	Two sets of gates	Birrell Street & Carrington Street (Part Of War Memorial Hospital Group)	S10594
Waverley	War Memorial Hospital Group:	Birrell Street Corner Carrington Street (War Memorial Hospital Group)	S10733
Waverley	Banksia and Wych Hazel	Birrell Street (Part Of War Memorial Hospital Group)	S6714
Waverley	Edina & Stables	Birrell Street (Part Of War Memorial Hospital Group)	S7379

### 6.7.3. Implications of non-statutory listing

The inclusion of the site on these prominent non- statutory lists provides recognition of the cultural significance of the site in a broad State and Commonwealth community level.

### 6.7.4. Building Regulations and Access Legislation

The National Construction code (NCC), incorporating the Building Code of Australia (BCA) and the Commonwealth Disability Discrimination Act (DDA) 1992 establish mandatory standards for new work, and some obligatory requirements for compliance of existing buildings and landscape. Works undertaken must also comply with the current NSW Work Health and Safety Act and the current NSW Work Safety Regulation.



The obligatory requirements for upgrading to these standards generally apply to fire safety, essential services, equitable access and work safety and occupational health standards.

For new work and obligatory upgrade works, the compliance with the NCC is framed in terms of performance standards, in compliance of which 'deemed to satisfy' requirements are defined. It is common practice in buildings of complexity such as St John's, for specific solutions to be engineered to meet fire egress requirements.

Compliance with the BCA does not signify compliance with the DDA. The provisions of the DDA are entirely qualitative. In 2010 the Commonwealth published the Disability (Access to Premises – Buildings) Standards. These are intended to ensure that the requirements of the Act are met.



## 7. Conservation Policies

### 7.1. Conservation Approach

Conservation includes all of the processes of looking after a place so that its cultural significance is retained. It is one aspect of the overall management of a place. The Burra Charter is the key document setting out the principles behind conservation in Australia, and the policies below have been formulated in accordance with the Burra Charter.

Conservation policies outline the ideal outcome in heritage terms. It is acknowledged that other factors must come into play in the management of any complex site. In such cases, management decisions which allow the greatest number of conservation policies to be met are to be strived for.

The main tangible aspects of the significance of the Waverley War Memorial Hospital are its aesthetic and historical qualities as a substantially intact Victorian estate. Therefore the conservation approach adopted for these policies relies on the spatial integrity of the place and its aesthetic qualities.

The following policies apply to the site as a whole. Further detailed policies should be developed for the four Victorian houses, stables, summerhouse, and War Memorial Hospital and Chapel.



Figure 11: Site plan illustrating conservation policies. (Source: Hector Abrahams Architects)

## 7.2. Policies

### 7.2.1. Definition of Place, Curtilage and Setting

For planning purposes, it is useful to clearly define a place and its setting. In conservation terms, the setting of a place is the “*environment of a place that is part of or contributes to its significance and distinctive character.*” (Burra Charter Article 1.12)

**Policy 1:** The place and curtilage should be defined as that part of the Edina estate which became the War Memorial Hospital in 1922 (see Figure 11). The setting should be defined as the original Edina estate boundaries and the streets which surround those boundaries: Bronte Road, Birrell Street, Church Street, and Carrington Street.

**Policy 2:** The name of the place “*Waverley War Memorial Hospital*” should continue to refer to the nature of the original hospital’s establishment as a memorial to the First World War.

### 7.2.2. Significant Fabric, Views, Spaces and Spatial Relationships

Much of the significance of a place is derived from its fabric. The term fabric is intended to include broadly the landform, landscape, plantings and vegetation, buildings and other site features, as well as views and spatial relationships. Defining the significant fabric helps in making decisions about the conservation of a place and in making sensitive changes to the place.

**Policy 3:** The fabric, views and spatial relationships ranked Exceptional and High should be conserved. They are:

- Victorian buildings and estate planning: topography, plantings, fences, statuary and spatial order (including the private street, original drive and distinction of service areas (stables and kitchen) from formal areas);
- War Memorial Hospital buildings of aesthetic importance: main building, chapel;
- 1920s landscape items: palm trees, cast iron bollards, reconfigured gates to Birrell Street / Bronte Road and new gates to Carrington Road;
- External views from Centennial Park of the Norfolk Island Pines;
- Existing views of the houses along Birrell Street and tower from Carrington Street (views 1, 2, 3 in Figure 11).

### 7.2.3. Uses and Governance

Use can form part of the significance of a place, especially when it is a historic use which is continuing. Conservation is aided by selecting a use for each space which is able to be accommodated with only minimal change to the significant fabric.

The medical / health care use which took over the private residential use in 1922 is of such long standing and significance in its own right that the medical use may by now be considered a historic use.

**Policy 4:** The existing institutional governance and hospital use is a historic use that should be continued.

**Policy 5:** The historic use should be broadly defined to include uses related to health, aged care and training.



**Policy 6:** The following historic spatial uses relating to the Victorian period should continue or be re-instated:

- early entrances and driveway;
- upper garden areas as garden / passive recreation.

#### 7.2.4. Interpretation and Reconstruction

The Burra Charter defines interpretation as “*all the ways of presenting the cultural significance of a place.*” (Article 1.17) Interpretation can include restoration and reconstruction (ways of returning a place to a known earlier configuration), signs, publications, artworks, lighting and access.

**Policy 7:** The place should be interpreted as the whole estate developed by the Vickery Family as a residence, and then as a result of a major gift, developed as a War Memorial Hospital.

**Policy 8:** Creatively interpreting aspects of the history of the place should be considered as opportunities arise, including

- Develop the site with an appreciation of its identity as a single planned estate;
- Develop the site with an appreciation of the spatial order of the estate, which is contiguous over all of its history to date.

**Policy 9:** The following reconstructions, removals and plantings should be considered:

- Removal of glass portico to reveal front entrance of 1935 Hospital;
- Replacement of concrete driveways with more sympathetic material;
- Reconstruction of grass bank to western side of Edina;
- Recreation of the original driveway path, in a manner similar to the original path (this would require the removal of buildings);
- Reconstruction of lower garden area (currently a carpark) to a garden area;
- Planting of trees which are missing from north west corner of the upper garden;
- Construction of a built form to close north end of service space behind Edina (where a Victorian outbuilding formerly stood);
- Construction of some built or garden form on site of original gatehouse (to mark entrance).

#### 7.2.5. Alterations to the Site (new buildings and landscape)

In many instances, changes will need to be made to significant fabric for good reasons. For example, the removal of some fabric of lower significance may be necessary in order to maintain fabric of higher significance. Generally, fabric of higher significance should be treated more cautiously than fabric of lower significance.

In this case, the site has the potential to be developed further in order to accommodate the continuing historic health care use. However, it would be less preferable to develop the site for different new uses.

The estate design is fundamentally orthogonal, but the arrangement of the carriage drive and the 1920s drive were carried out in the picturesque mode.

Alterations to the site must be careful of the significant fabric of the place and its potential underground archaeological deposits, predominantly the site of the demolished wing to the east of Vickery and the central pond as shown in Figure 11.

**Policy 10:** The siting of new buildings must respect the integrity of estate, its orthogonal and picturesque layouts, and the historic sequence of spaces. New buildings may be placed in the historic lower garden and service court spaces provided those spaces remain discernible. They may replace buildings assessed as being of moderate or low significance. New buildings should not be placed in the upper garden space.

**Policy 11:** the scale of new buildings should be of a scale consistent with the estate. This allows for large buildings; however, new buildings should not challenge the landmark qualities of the Edina tower or the Norfolk Island pines.

**Policy 12:** the character of new buildings and new landscape features should appear to be a development of the estate as a whole, in a similar way that the 1935 War Memorial Hospital appears in relation to Edina.

**Policy 12:** Should works involve areas of potential archaeological deposits, plan for proper investigation and interpretation of those deposits.

#### 7.2.6. Technical Oversight and Review of plan

**Policy 13:** Involve the standard of professional and craft expertise appropriate to each grade of significance in each area of the site.

**Policy 14:** Review this plan in step with the timing of review of the strategic plan of the Hospital and its masterplan, or when works are proposed to fabric or spaces of Exceptional or High Significance.





## 8. Appendix

### Detailed Account of the Development of the Estate

The following pages have a reproduction of Section 2 – Historical Analysis written for the 2005 Conservation Management Plan by John Oultram Heritage and Design. The history covers

- 2.1 Suburban Context
- 2.2 The Edina Estate
- 2.2 (sic) The War Memorial Hospital
- 2.3 Site Development

# PART F DEVELOPMENT SPECIFIC

## Contents

<b>F1</b>	<b>SHARED RESIDENTIAL ACCOMMODATION.....</b>	<b>483</b>
<b>F2</b>	<b>TOURIST AND VISITOR ACCOMMODATION.....</b>	<b>485</b>
2.1	Backpacker Accommodation .....	485
2.2	Hotels and Motels.....	487
2.3	Serviced Apartments .....	488
<b>F3</b>	<b>CHILD CARE CENTRES.....</b>	<b>489</b>
<b>F4</b>	<b>PLACES OF PUBLIC WORSHIP.....</b>	<b>490</b>
4.1	Locational and Site Requirements.....	490
4.2	Bulk, Scale and Design .....	491
4.3	Acoustic Privacy .....	492
4.4	Open Space Areas.....	493
4.5	Traffic, Parking and Access .....	494
4.6	Operational Plan of Management .....	495
<b>F5</b>	<b>HORTICULTURE.....</b>	<b>496</b>

## F1 SHARED RESIDENTIAL ACCOMMODATION

This Part contains guidelines for student housing, boarding houses, co-living housing, group homes and hostels throughout Waverley. These types of development must also conform to *Part B General Provisions (specifically B17 Social Impact Assessment)*, *Part C Residential Development* and *Part E Site Specific Development* where relevant.

The *State Environmental Planning Policy (Housing) 2021* (Housing SEPP) outlines provisions for boarding houses relating to the following:

- Density;
- Height;
- Landscaping and Private Open Space;
- Solar Access and Energy efficiency;
- Car Parking; and
- Accommodation size and characteristics.

The Housing SEPP has a number of standards that cannot be used to refuse consent. The provisions in this section provide further guidance in addition to the Housing SEPP.

**Note:** Places of shared residential accommodation are to be registered annually with Council and be inspected at least once a year by Council.

### Objectives

- (a) To provide a level of amenity to ensure acceptable living standards.
- (b) To ensure rooms have sufficient kitchen and bathroom appliances in order to be completely self-contained.
- (c) To provide ample space for cooking and dining whilst maintaining health and safety.
- (d) To ensure all types of shared residential accommodation are adequately managed and maintained.

### Controls

- (a) An application for shared accommodation must be accompanied by a Plan of Management as outlined in the *Waverley Development Application Guide*. Plans of Management are subject to community consultation and must be approved by the relevant consent authority.
- (b) An indoor communal living area is to have a minimum area of 12.5m<sup>2</sup> or 1.25m<sup>2</sup>/resident (whichever is greater). The communal area is not to include bedrooms, bathrooms, laundries, reception area, storage, kitchens, car parking or the like.
- (c) A combined communal kitchen and dining area may be provided, and should have a minimum area of 15m<sup>2</sup> with an additional 1m<sup>2</sup> for each room greater than 12 rooms.
- (d) A communal storage space is to be provided that can house items for communal use.
- (e) Each room should contain adequate storage facilities to provide storage space for clothes, linen, kitchenware, large bulky items and other items.
- (f) Balconies are encouraged to be provided for each individual room where site and locality conditions permit.



## Shared Residential Accommodation F1

- (g) Laundry facilities are to be provided at the rate of one washing machine and laundry basin for every 12 residents.
- (h) Clothes drying facilities are to be provided for occupants, including an outdoor clothes line.
- (i) A room with a kitchenette should contain a stove, sink, oven, refrigerator and a bench top with a minimum area of 1m<sup>2</sup>.
- (j) Bathrooms should have a minimum area of 5m<sup>2</sup>.
- (k) Rooms should be well naturally ventilated to ensure acceptable levels of health and safety.
- (l) A communal open space is to be provided for relaxation, dining, entertaining and recreation purposes.
- (m) Sections of the site not built upon should be landscaped with trees, shrubs and ground cover.
- (n) Boarding houses and co-living housing are to be designed to minimise and mitigate any impacts on the visual and acoustic privacy of neighbours by locating:
  - (i) The main entry point at the front of the site, away from side boundary areas near adjoining properties;
  - (ii) Communal areas away from the main living area or bedroom windows of any adjacent buildings;
  - (iii) Screen fencing, plantings and acoustic barriers in appropriate locations; and
  - (iv) Double glaze windows or glass blocks where noise transmission could affect neighbour properties.
- (o) Council may permit front fences up to a height of 1.8m and/or of solid material provided it can be shown that the fence acts as an effective noise barrier as a result of adjoining a street with high traffic volume. Such fences are to be setback from the boundary to allow landscaping to soften the bulk or the structure is to be articulated as an alternative to a solid blank wall.

## F2 TOURIST AND VISITOR ACCOMMODATION

This Part contains provisions that apply to alterations and additions, change of use to, or new visitor accommodation. Tourist and visitor accommodation includes:

- Backpackers' accommodation;
- Bed and breakfast accommodation;
- Hotel or motel accommodation; and
- Serviced apartments.

### Controls

- (a) Development is to be designed in accordance with this Part, and any relevant sections in *Part C Residential Development*, *Part D Commercial Development* and *Part E Site Specific Development*.

### 2.1 BACKPACKER ACCOMMODATION

#### Objectives

- (a) To protect existing residents from the impacts of backpacker accommodation.
- (b) To ensure the design, development and management of backpacker accommodation provides a high standard of amenity for guests.
- (c) To ensure that backpacker accommodation is located within close proximity to public transport, services and facilities and away from predominantly residential uses.

#### Controls

- (a) Backpacker accommodation is to be located within 400m of public transport and within easy access to facilities and services.
- (b) The number of people in shared or dormitory style accommodation will be determined by allocating a minimum of 3.25m<sup>2</sup> of floor area per person up to a maximum of 8 guests per room.
- (c) The maximum length of stay for guests is 28 consecutive days.
- (d) A site manager must be on site at all times. For premises with less than 20 residents, a resident caretaker may be acceptable.
- (e) A staff room/site manager's office, and a sleeping room for the site manager/resident care taker must be provided.
- (f) Sleeping rooms are not to contain cooking facilities.
- (g) One communal area of at least 20m<sup>2</sup> with a minimum dimension of 3 metres is to be provided.
- (h) Communal recreation areas are to be provided at the rate of 0.75m<sup>2</sup> per person based on the maximum number of guests.
- (i) Outdoor recreation areas are encouraged where appropriate, and adequate noise and visual privacy can be provided for neighbouring properties.
- (j) A combined kitchen/living area is to be provided, with a minimum size of 1m<sup>2</sup> per occupant.
- (k) Toilet facilities must be provided in a separate compartment from the showers/bathroom and provide adequate privacy for guests.

- (l) A minimum of one bathroom for males and one bathroom for females is to be provided.
- (m) Rooftop terraces are not permitted.
- (n) Developments are to be designed to minimise and mitigate any impacts on the visual and acoustic privacy of neighbours by locating:
  - (i) The main entry point at the front of the site, away from side boundary areas near adjoining properties;
  - (ii) Communal areas away from the main living area or bedroom windows of any adjacent buildings;
  - (iii) Screen fencing, plantings and acoustic barriers in appropriate locations; and
  - (iv) Double glazed windows or glass blocks where noise transmission could affect neighbouring properties.
- (o) Provide adequate space and secure storage facilities to allow occupants to store clothes and travel gear.
- (p) Council may permit front fences up to a height of 1.8m and/or of solid material provided it can be shown that the fence acts as an effective noise barrier as a result of adjoining a street with high traffic volume. Such fences are to be setback from the boundary to allow landscaping to soften the bulk or the structure is to be articulated as an alternative to a solid blank wall.

**2.2 HOTELS AND MOTELS****Objectives**

- (a) To ensure the design, development and management of hotel and motel accommodation provides a high standard of amenity for guests.
- (b) To ensure that the amenity of the surrounding area is not unduly compromised.

**Controls**

- (a) The maximum permitted length of stay is 3 months for motels and hotels.
- (b) Sleeping rooms are to provide a minimum of 5.5m<sup>2</sup> per occupant staying more than 28 consecutive days; or 3.25m<sup>2</sup> per occupant staying 28 or less consecutive days.
- (c) Where a hotel or motel is located within a building that includes residential flats, separate ground floor lobbies and access corridors are required for each use.
- (d) Each bedroom is to accommodate a maximum of two persons.
- (e) Provide adequate space and secure storage facilities to allow occupants to store clothes and travel gear.
- (f) Buildings must be oriented and designed to minimise potential impacts on surrounding residential amenity.

## 2.3 SERVICED APARTMENTS

### Objectives

- (a) To ensure that serviced apartment developments provide a high level of amenity for guests.
- (b) To ensure that serviced apartment developments provide a level of health and amenity for residents to ensure any future conversion to residential flats is not compromised by poor amenity.
- (c) To ensure that the amenity of the surrounding area is not unduly compromised by the development of serviced apartments.

### Controls

- (a) Serviced apartments are to be designed so that the level of residential amenity within each apartment is equivalent to that required to be provided for residential apartments.
- (b) Where serviced apartments are located within a building that includes residential flats, separate ground floor lobbies, lift access and circulation must be provided for each use.
- (c) Washing machine and clothes drying facilities are to be provided within the premises for the use of guests.
- (d) Each bedroom is to accommodate a maximum of two people.
- (e) Provide adequate space and secure storage facilities to allow occupants to store clothes and travel gear.
- (f) Buildings must be oriented and designed to minimise potential impacts on the surrounding residential amenity.
- (g) Development for serviced apartments is to provide a mix of apartment types.
- (h) Development is to provide adequate space for waste storage and collection in accordance with *Part B1 Waste*.

**F3 CHILD CARE CENTRES****State Environmental Planning Policy (Transport and Infrastructure) 2021**

The *State Environmental Planning Policy (Transport and Infrastructure) 2021*, or the Transport and Infrastructure SEPP provides provisions for the exempt and complying development of education and child care facilities. The Transport and Infrastructure SEPP also provides provisions for the development of centre-based child care facilities and schools. To support the Education SEPP, the *Child Care Planning Guideline 2017* (CCPG) provides guidance to encourage design quality in the delivery of centre-based child care in NSW.

Development Applications for centre-based child care facilities are to comply with the provisions of the CCPG.

**Children and Young Persons (Care and Protection) Act 1998 and Education and Care Services Regulations 2011**

Child Care Services are managed under the *Children and Young Persons (Care and Protection) Act 1998* and the *Education and Care Services Regulations 2011*. The Regulation covers areas such as the staff who work in services and their level of qualification, the size of a service and the ratio of staff to children, physical requirements of building spaces and equipment, health and safety and administrative requirements. An application for a license cannot be made until development consent has been granted.

For more information go to: <http://www.dec.nsw.gov.au/>

**Licensing and Management**

Council has the responsibility for assessing child care centre applications and the NSW Department of Education is responsible for the regulation, licensing and monitoring of children's services in accordance with the state regulations under the *Children and Young Persons (Care & Protection) Act 1998* and *Education and Care Services Regulations 2011*.

An applicant must obtain a licence from the Department of Education to provide centre-based child care once a development application (DA) has been approved, or for a home-based child care centre. Before submitting a DA, the applicant should contact the Department of Education to address licensing issues. Contact details are available at the following link:

<http://www.dec.nsw.gov.au/contact-us>

## F4 PLACES OF PUBLIC WORSHIP

Waverley has a rich and vibrant community that requires establishments to congregate for the purposes of worship and to gather for community events. Such establishments are an important part of our urban environment, and this part aims to ensure that these establishments are able to operate respectfully within the local environment.

### Objectives

- (a) To minimise and manage the impacts of places of public worship on the amenity of residential areas.
- (b) To ensure that places of public worship have a scale and intensity that is suitable to the site and context.
- (c) To ensure that places of public worship are able to operate respectfully within the urban context.
- (d) To provide guidance for the preparation of a plan of management.
- (e) To encourage the location of larger places of public worship in lands zoned for business purposes.

### 4.1 LOCATIONAL AND SITE REQUIREMENTS

#### Objectives

- (a) To prevent unacceptable impacts on the amenity of residential areas by encouraging the location of larger places of public workshop within non-residential zones.
- (b) To guide the appropriate location of places of public worship to ensure that amenity for surrounding residents and businesses is maintained.
- (c) To ensure that places of public worship and educational establishments are appropriate with regard to the character and use of the area.
- (d) To ensure that sites and streets are capable of servicing the use of the facilities.

#### Controls

- (a) Proposals for new places of public worship, or for the intensification of an existing place of public worship, must clearly address the management of amenity, safety and traffic that will result from the intensification of the site in both the Statement of Environmental Effects and the Plan of Management.
- (b) New large places of public worship (ie. with a maximum seating capacity of greater than 200) are preferred to be located within lands zoned for business purposes or special uses.
- (c) Places of public worship are not supported to be located on cul-de-sacs.
- (d) Places of public worship proposed in residential zones are to provide landscaping and open space to 25% of the site area.
- (e) In residential areas, a minimum 900mm landscaping strip between side setbacks is required.
- (f) Places of public worship are to provide front, rear and side setbacks in line with surrounding properties.

## 4.2 BULK, SCALE AND DESIGN

### Objectives

- (a) To maintain the residential character of established residential areas.
- (b) To ensure that the scale of places of public worship is consistent with the scale of existing or likely future development in the area.

### Controls

- (a) Development must be sensitive to the streetscape character and views. A streetscape and context analysis is to be provided in accordance with *Part B12 Design Excellence*.
- (b) Places of public worship are to be designed and landscaped in a manner that enhances the quality and visual amenity of the streetscape.
- (c) New development for the purpose of a place of public worship within a residential zone is to have a maximum seating capacity of 200.
- (d) Entries to a place of worship must be in clear view of the street.
- (e) Where a place of public worship has a dual frontage, the development is to address both streets.
- (f) The location of windows, doors or balconies is to minimise overlooking or loss of privacy to adjacent residential properties.

**Note:** Consideration may be given to minor variation of the applicable WLEP height standard to accommodate the unique architectural requirements of places of public worship establishments, provided there is no resulting loss of amenity to surrounding properties.



### 4.3 ACOUSTIC PRIVACY

#### Objectives

- (a) To minimise noise levels from places of public worship that may impact upon neighbouring or nearby properties.
- (b) To ensure that places of worship are able to function within appropriate hours of operation and offer services appropriate to the function of the facility.

#### Controls

- (a) The design of the proposed place of public worship must minimise the projection of noise from any activities carried out within the site.
- (b) Adjoining and nearby residents should not be exposed to unreasonable levels of noise arising from the proposed use.
- (c) A noise impact assessment statement, prepared by a suitably qualified acoustic engineer, is to be submitted for development within residential zones or adjoining residential zones that proposes:
  - i. A new Place of Public Worship;
  - ii. New outdoor activities; or
  - iii. Intensification of existing activities.The statement should describe hours of operation and predicted noise levels for regular outdoor activities and for special events such as festivals and religious celebrations.
- (d) Activities are to be carried out within the hours of operation outlined in the plan of management.

#### 4.4 OPEN SPACE AREAS

##### Objectives

- (a) To provide adequate open space areas for passive and active recreational activities for places of public worship.

##### Controls

- (a) Where open space is proposed, an Open Space Plan is to be included with the development application. The plan is to:
  - (i) identify the amount of open space area to be provided;
  - (ii) identify the types of open space area to be provided, including indoor and outdoor recreation spaces, and the proposed uses for these spaces;
  - (iii) identify any potential opportunities for public access to the open space when not in use by the place of worship; and
  - (iv) identify the likely effects of the use of open space areas on the amenity of nearby residents (including how often and the type of activities to occur) and measures to mitigate and manage the impacts of noise on adjoining properties.

## 4.5 TRAFFIC, PARKING AND ACCESS

### Objectives

- (a) To ensure that pedestrian safety is maintained and protected.
- (b) To ensure that the surrounding street network and intersections continue to operate effectively and within design parameters.
- (c) To minimise the impact of parking related to use of the place of public worship on the local streets.
- (d) To minimise adverse impacts upon the amenity of the neighbourhood.

### Controls

- (a) A traffic impact statement is to be included with the development application. The statement shall:
  - (i) Assess the impact upon the surrounding streets and the measures proposed to mitigate such impacts.
  - (ii) Identify the number of parking spaces required on the basis of the general use of the site.
  - (iii) Identify the frequency of events (e.g. carnivals, celebrations, festivals, services), the attendance numbers associated with such events, and measures to mitigate and manage their impacts associated with traffic movements.
- (b) Clear distinctions should be made for vehicular traffic and pedestrian movements, both onsite and off-site. Measures should be taken to separate these and reduce potential conflict through design and management practices.
- (c) Off-street car parking must be integrated within the building envelope or within the footprint of the development.
- (d) Development is to comply with the provisions of *Part B8 Transport*.
- (e) The provision of parking is not to preclude the provision of landscaping.
- (f) New places of public worship, or places of public worship seeking to expand operations, are to provide a Green Travel Plan to demonstrate:
  - (i) The proximity of the facility to public transport;
  - (ii) How users of the facility will minimise the requirements for parking in the surrounding streets; and
  - (iii) How users of the facility will minimise the traffic generated by the facility.

## 4.6 OPERATIONAL PLAN OF MANAGEMENT

### Objectives

- (a) To provide certainty for both the consent authority and the local community about the ongoing management practices to be employed by the proposed use to manage its impact upon the neighbourhood.

### Controls

- (a) A development application for the purposes of establishing a new place of public worship, or for alterations or additions to an existing place of public worship must include an Operational Plan of Management (refer to the *Waverley Development Application Guide*). The Operational Plan of Management (as may be amended) will be incorporated as a condition of development consent. This plan must include, but is not limited to the following information:
  - (i) Details of the proposed hours of operation, a schedule of regular services held and recurring events and special events throughout the year. Details including the expected numbers of people are to be provided.
  - (ii) A list of the types of community purposes the building may be used for outside the regular services is to be provided, including information regarding how often and how many people such activities are likely to attract. Examples include community colleges, senior citizens groups, presentations and workshops, youth groups, etc.
  - (iii) A list of the type of organisations that may let or use the building and for what purposes, how often and how many people this is likely to attract.
  - (iv) An explanation of the measures that will be in place to manage parking and local traffic when a special event is scheduled.
  - (v) The estimated number of people to be in attendance at regular services, main events and those other times where it is described that the place of public worship will be in use.
  - (vi) Contact persons who will be responsible for complaints handling. This is to be updated periodically.
- (b) Where Council is aware of community complaints, it may request a revision of the Operational Plan of Management.

**F5 HORTICULTURE**

This Part contains provisions that apply to Development Applications involving the horticulture land use. In accordance with the WLEP, 'horticulture' is a type of intensive plant agriculture. It means the cultivation of fruits, vegetables, mushrooms, nuts, cut flowers and foliage and nursery products for commercial purposes, but does not include a plant nursery, turf farming or viticulture.

**Objectives**

- (a) To ensure that operation does not impact on the amenity of the area or disrupt nearby residential properties.
- (b) To prevent food grown on contaminated land.
- (c) To prevent the contamination of land and water.

**Controls**

- (a) The horticulture operation must be conducted in a 'Controlled Environment Agriculture' manner.
- (b) Pesticide use must not create land contamination.
- (c) Water pollution may not occur.
- (d) Measures must be taken to ensure that no adverse odour, noise or light (from UV lights) impact is produced for neighbouring sites.
- (e) Proposals must comply with Part D Commercial Development.

**Note:** Terms used in this Plan are defined in Waverley LEP and the Act and override any identical definition in this dictionary. The definitions below refer to terms that are not defined by either the LEP or the Act.

### A

**A-Board** (or sandwich board) - means a two sided structure generally located on the footpath outside a shop or arcade to advertise a particular shop or product.

**Accessible Housing** - Housing that is designed and built to accommodate the needs of occupants with mobility impairment (Australian Standard 1428: Design for Access and Mobility Services).

**Active Frontage** - Street frontages where there is an active visual engagement between those in the street and those of the ground floors of buildings. Frequent building entries that face and open towards the street, transparent street frontages, quality materials and refined details, and mixed land use help to provide active frontages.

**Active Solar Energy Systems** - Systems which combine the sun's energy with local climatic conditions to achieve thermal comfort inside buildings with the use of mechanical devices.

**Adaptable housing** - Dwellings designed in accordance with the requirements under Australian Standard AS4299 – 1995 Adaptable Housing.

**Adjoining Land** - Land which abuts an application site or is separated from it only by a pathway, driveway, laneway, roadway or similar thoroughfare.

**Advertised Development** - Development, other than designated development, that is identified as advertised development by the regulations, an environmental planning instrument or a development control plan.

**Affected Person** - A person, organisation, company or the like who owns or occupies land that adjoins an application site; who, in the opinion of the authorised Council officer, may be detrimentally affected by the use of an application site or the erection of a building or carrying out of works on an application site; or who occupies a building (including but not limited to a boarding house or an individual unit within a residential flat building) that is the subject of a development application.

**Alteration and Addition** - Any alteration or addition requiring a development application.

**Applicant** - The person(s) making a development application to Council.

**Application Site** - The land to which the development application applies.

**Attic** – Refer to the term “Attic” as defined in the dictionary within Waverley Local Environmental Plan.

**Australian Standard** – The structural, technical and building requirements prepared by the Standards Australia Committee and approved by Council of Australian Standards.

**Authorised Council Officer(s)** - The Council officer(s) who are responsible for the processing, assessment or determination of an application.

**Awning** - A roof like structure that protrudes from the wall of a building, either over a window or doorway.

**Awning Fascia Sign** - A painted or adhered sign positioned on the fascia or return end of an awning.

**Annual Exceedance Probability (AEP)** - The chance of a flood of a given or larger size occurring in any one year, usually expressed as a percentage.

**Australian Height Datum (AHD)** - A common national plan of level corresponding approximately to mean sea level.

**ARR 1987** - Australian Rainfall and Runoff: 1987 published by the Institute of Engineers, Australia.

**ARR 2019** - Australian Rainfall and Runoff 2019, published by the Commonwealth of Australia (Geoscience Australia).

## B

**Base Flows** - Flows that occur during dry weather conditions.

**Biodiversity** - The variety of life: the different plants, animals and microorganisms, the genes they contain and the ecosystems of which they form. Biodiversity is vital in supporting human life. It provides many benefits, including our food, clean air and water and fertile soils.

**Blackwater** - Wastewater generated from toilets.

**Body Corporate** - An owner's corporation constituted under Section 11 of the *Strata Schemes Management Act 1996*.

**Bulk** - The combination of volume, size and shape of a building.

**Basement Car Parking or Below Ground Car Parking** - The car parking area generally below ground level where inundation of the surrounding areas may raise water levels above the entry level to the basement, resulting in inundation. Basement car parks are areas where the means of drainage of accumulated water in the car park has an outflow discharge capacity significantly less than the potential inflow capacity.

## C

**Café (See Restaurant)**

**Canopy** - means an overhanging protection or shelter usually found over a window or door.

**Carport** - An open sided roof structure with no door or walls and used for car-parking purposes only.

**Collection Point** - The usual (or agreed) point on the footpath/roadway, or on-site, where garbage and recyclables are loaded onto vehicles.

**Compost Bin** - A container to hold organic and biodegradable waste while it is being converted into soil conditioner, compost or humus by a biological decay process.

**Consulting Arborist** - An Australian Qualification Framework Level V arborist (AQF5) or equivalent

**Consent Authority** - Waverley Council unless otherwise stipulated in accordance with this Plan.

**Conservation Area** - means an area of land of heritage significance:

- a) shown on the Waverley Local Environmental Plan Heritage Map as a heritage conservation area, and
- b) the location and nature of which is described in Waverley Local Environmental Plan Schedule 5, and includes any heritage items situated on or within that area.

**Contributory Item** - items that make an important and significant contribution to the character of a heritage conservation area. This not only includes buildings, but natural features such as topography, vegetation, and views as well.

**Council** - Waverley Council

**Critical Habitat** - An area or areas of land comprising the habitat of an endangered species, population or ecological community

**Critical Facilities** - Includes hospitals and ancillary services, communication centres, police, fire SES, major transport facilities, sewerage and electricity plants; any installations containing critical infrastructure control equipment and any operational centres for use in a flood.

## D

**Damage (to a tree)** - Injury to a tree or vegetation and includes:

- pruning, lopping and topping
- poisoning, including applying herbicides and other plant toxic chemicals to a tree or spilling of oil, petroleum, paint, cement, mortar and the like onto the root zone
- cutting, tearing, breaking or snapping of braches and roots that is not carried out in accordance with accepted arboricultural practices or is done for invalid reasons, including vandalism
- ringbarking, scarring the bark when operating machinery, fixing objects by nails, staples or wire or fastening materials that circle and significantly restrict the normal vascular function of the trunks or branches
- damaging a trees root zone by compaction or excavation, asphyxiation including unauthorised land filling or stockpiling of materials around the tree trunk, and / or
- underscrubbing, or clearing understorey plants.

**Dead tree** - Any tree that is no longer capable of performing any one of the following processes:

- photosynthesis



- take up of water through the root system
- hold moisture in its cells; or
- produce new shoots

**Deep Soil Zone** - site area that is not built on, or underneath, thereby leaving an area of deep soil for deep-rooted vegetation, native vegetation and natural drainage. The zone must have a minimum dimension of 2 by 2 metres and should be positioned to enable the retention of existing mature and / or significant trees.

**Destroy** - Any activity leading to the immediate or contributes to the death, disfigurement or mutilation of a tree

**Designated Development** - Development as specified under section 4.10 of the *EP&A Act 1979* to be development that is declared to be designated by an environmental planning instrument or regulation.

**Desired Future Character** - the character of a development that complies with the aspirations expressed within the objectives and provisions of the Waverley LEP and DCP and any other relevant plans adopted by Council.

**Detention** - The holding of stormwater for short time periods aimed at reducing high flows. This reduces the peak flow of runoff, not the volume.

**Detention Basin** - A storage area used to temporarily store stormwater flows during a storm event to reduce peak flow. No water is permanently stored in a Detention Basin but is released to the stormwater system following the peak flow event.

**Development** - The use of land, and the subdivision of land, and the erection of a building, and the carrying out of a work, and the demolition of a building or work, and any other act, matter or thing referred to in Section 3.14 of the *EP&A Act 1979* that is controlled by an environmental planning instrument but does not include any development of a class or description prescribed by the *Regulations 2021* for the purposes of this definition.

**Development Application** - An application for consent under Section 1.4 of the *EP&A Act 1979*, to carry out development but does not include an application for a complying development certificate.

**Dormer** - A construction containing a vertical window framed into and projecting through a sloping roof.

## E

**External Wall Height** - "Wall height" is the vertical distance as measured from the ground level (existing or as determined by Council) to the highest point of an external wall. The highest point of an external wall is taken to be any of the following:

- the underside of the eaves of a pitched roof;
- the highest point of a parapet that forms part of an external wall;
- the highest point of the wall where it joins the roof structure for skillion or butterfly type roofs.

For the purposes of "wall height" an external wall does not include dormer windows, roof gable ends, clerestory windows, recessed/setback glazed walls designed to obtain internal light, or the like.

**Effective Warning Time** - The time available after receiving advice of an impending flood and before the floodwaters prevent appropriate flood response actions being undertaken. The effective warning time is typically used to raise furniture, evacuate people, and transport their possessions.

**Evacuation** - The transfer of people and or stock from areas where flooding is likely, either close to, or during a flood event. It is affected not only by warning time available, but also the suitability of the road network, available infrastructure, and the number of people that have to evacuate during floods.

## F

**Fascia Sign** - A sign painted or positioned on the fascia or return end of the awning.

**Fill** - Depositing soil, rock or other similar extractive material obtained from the same or another site, but does not include the depositing of topsoil or feature rock imported to the site that is intended for use in garden landscaping, turf or garden bed establishment or top dressing of lawns and that does not significantly alter the shape, natural form or drainage of the land or a waste disposal landfill operation.

**Fin Sign** - An advertising structure attached to a flat roofed building or structure (such as a service station driveway canopy), generally positioned at right angles to street frontage.

**Flush Wall Sign** - A sign attached to or painted onto the wall of a building.

**Food Waste** - Any food waste such as vegetables, cereals, bones, meats and fish and fatty and oily sludges such as de-watered grease trap wastes.

**Flood** - A natural phenomenon that occurs when water covers land that is normally dry. It may result from coastal inundation (excluding tsunamis) or catchment flooding, or a combination of both.

**Flood compatible building components** - A combination of measures incorporated in the design and/or construction and alteration of individual buildings or structures subject to flooding, and the use of flood compatible materials for the reduction or elimination of flood damage.

**Flood compatible materials** - Those materials used in building which are resistant to damage when inundated.

**Flood evacuation strategy** - The proposed strategy for the evacuation of areas within effective warning time during periods of flood as specified within any policy of Council, the Floodplain Risk Management Plan (FRMP), the relevant State Government disaster plan, or by advice received from the State Emergency Services (SES)..

**Flood proofing** - A combination of measures incorporated in the design, construction and alteration of individual buildings or structures subject to flooding, to reduce or eliminate flood damages. Examples include use of tiled surfaces and installing power points above flood planning levels etc.

**Flood refuge area** - An onsite refuge above the PMF that provides reasonable shelter for the likely occupants of the development commensurate with the period of time that refuge is likely to be required in floods up to the PMF.

Note: In general, it is not acceptable to rely on a refuge provided by or on other development sites. In all cases where an onsite refuge is provided, it is to be both intrinsically accessible to all people on the site, sheltered and an integrated part of the development (i.e. a second storey with internal stair access). The route to the refuge is to be fail safe, plainly evident and self-directing.

**Flood Fringe Areas** - The remaining areas of flood prone land after floodway and flood storage areas have been identified.

**Floodway Areas** - Areas of the floodplain where a significant discharge of water occurs during floods. They are often aligned with naturally defined channels. Floodways are areas that, even if only partially blocked would cause a significant redistribution of flow or a significant increase in flood levels.

**Flood Storage Areas** - Floodplain area that is important for the temporary storage of floodwaters during a flood.

**Flood Study** - A study prepared for one or more floodplains in accordance with the requirements of the FDM (superseded) or FRMM.

**Floodplain** - (Synonymous with flood liable and flood prone land) is the area of land that is subject to inundation by the PMF.

**Floodplain Development Manual (FDM)** - Floodplain Development Manual (2005).

**Flood Risk Management Manual** – Flood Risk Management Manual and associated Flood Risk Management Toolkit (2023).

**Floodplain Risk Management Plan (FRMP)** - A plan prepared for one or more floodplains in accordance with the requirements of the FDM (superseded) or FRMM.

**Floodplain Risk Management Study (FRMS)** - A study prepared for one or more floodplains in accordance with the requirements of the FDM (superseded) or FRMM).

**Freeboard** - A factor of safety typically used in relation to the setting of minimum floor levels or levee crest levels

## G

**Garage** - An enclosed structure with a roof, garage door and walls used for carparking purposes only.

**Garbage** - is any solid or inert materials generated by development and land-use activities (including domestic activities) that are discarded, rejected, unwanted, surplus or abandoned, that remains after the separation of compostable, re-useable and recyclable materials.

**Garbage Chute** - is a duct in which deposited material descends from one level to another within the building, due to gravity.

**Green Roof** - is a roof that is designed to promote the growth of various forms of vegetation and includes a vegetated layer, growing medium, drainage layer and a waterproof membrane. The roof is either partially or completely covered by vegetation, and is a non-trafficable space that is only accessed for maintenance purposes.

**Green wall / Vertical garden** - Green wall means walls that are either free-standing or part of a building that is partially or completely covered with vegetation. There are two main types of green wall, including:

- green façades, that are made up of climbing plants either growing directly on a wall or on specially designed supporting structures. The plant's shoot system grows up the side of the building while being rooted in the ground; and
- living walls, with modular panels are affixed to the wall and geo-textiles, irrigation and a growing medium combine to support a dense network of plants.

**Green Waste** - A vegetative material, such as grass, plants, leaves, branches, shrub and tree loppings.

**Grey Water** - Wastewater generated from hand basins, showers, laundries and kitchens.

**Gross Leasable Area** - The sum of the areas at each floor of a building, where the area of each floor is taken to be the area within the internal faces of the walls, excluding stairs, amenities, lifts, corridors and other public areas but including stock storage areas.

**Gross Floor Area** – As per the definitions in the Waverley Local Environmental Plan, with 'car parking' and 'access to that car parking' in the WLEP definition referring to the minimum dimensions and access required in order to comply with requirements of AS2890 and the National Construction Code (NCC) – Building Code of Australia (BCA). Car parking spaces above the 'maximum' stated in the WDCP, and components of parking and access areas greater than the minimum dimensions required to meet the AS2890 and the BCC/BCA will contribute to the Gross Floor Area calculation.

**Groundwater** - Water contained within the voids and spaces in rocks or soils.

## H

**Habitable** - In a residential situation: a living or working area, such as a lounge room, dining room, rumpus room, kitchen, bedroom or workroom; In an industrial or commercial situation: an area used for offices or to store valuable possessions susceptible to flood damage in the event of a flood.

**Habitable Room** - A room in a dwelling used for domestic day to day activities that excludes a bathroom, laundry, water closet, food storage pantry, walk in wardrobe, corridor, hallway and other like spaces not occupied for extended periods of time.

**Habitat Corridors** - are areas where vegetation provides sufficient habitat features to allow wildlife to move from one area of habitat to another. The vegetation may include remnant bushland, native plantings, weeds and gardens.

**Habitat tree** - Any tree that is a nest or hollow-bearing tree which is suitable for nesting birds, arboreal marsupials (possums), micro-bats or which support the growth of locally indigenous epiphytic plants such as orchids

**Hardstand area** - An open paved, concrete or grassed space designed to allow for car parking.

**Hazardous Material** - Potentially hazardous or toxic material(s) that contribute to the toxicity of residual waste. They include but are not limited to, asbestos, used batteries, waste oils, paints, solvents, cleaning and pool chemicals, pesticides, poisons and sharps such as syringes.

**Hazardous Substances** - A substance that:

- is listed in the *List of Designated Hazardous Substances*, (as listed on [www.ascc.gov.au](http://www.ascc.gov.au)) or
- fits the criteria set out in the 'Approved Criteria for Classifying Hazardous Substances', as published by the National Occupational Health and Safety Commission.

**Height of a tree** - means the distance measure vertically between the horizontal plane of the lowest point of the base of the tree, which is immediately above ground, and the horizontal plane of the uppermost point of the tree.

### I

**Impervious (non porous)** - A surface that does not allow water to infiltrate into the ground, including roofs, roads, pavements, hard surfaced sports courts, any "sealed" areas and permanent water bodies such as swimming pools.

**Indigenous plant species** - Those species which are believed to have been present in the Waverley Council area prior to 1788. It includes those plants which originate from remnant vegetation via natural processes and does not include planted native plants or plants originating from plantings.

**Infill** - A new building, either in a heritage conservation area or an existing urban area.

**Infiltration** - is the downward movement of water from the surface to the subsoil.

**Injury** - Damage to a tree and includes:

- lopping and topping
- poisoning, including applying herbicides and other plant toxic chemicals to a tree or spilling of oil, petroleum, paint, cement, mortar and the like onto the root zone
- cutting, tearing, breaking or snapping of braches and roots that is not carried out in accordance with accepted arboricultural practices or is done for invalid reasons, including vandalism
- ringbarking, scarring the bark when operating machinery, fixing objects by nails, staples or wire or fastening materials that circle and significantly restrict the normal vascular function of the trunks or branches
- damaging a trees root zone by compaction or excavation, asphyxiation including unauthorised land filling or stockpiling of materials around the tree trunk, and / or
- underscrubbing, unless carried out by hand tools such as brushcutters and the like

**Integrated Development** - Development that in addition to Council consent, requires a number of permits, licences and other approvals from public authorities as well as approval under the *EP&A Act 1979*.

**Interallotment Drainage** - Common stormwater drainage system that serves one or more private properties.

**Imminent danger** – The risk is immediate and present at that particular moment to human life or substantial property damage.

### L

**Landscaped Area** - A part of a site used for growing plants, grasses and trees, but does not include any building, structure or hard paved area

**Laneway Development** - A building which fronts a rear lane.

**Liquid Waste** - A non-hazardous liquid waste generated by commercial premises that is supposed to drain to the sewer or be collected for treatment by a liquid waste contractor (inc. grease trap waste).

**Local Native Plants** - Those plants that have been propagated from local seed stocks from Sydney's Eastern suburbs, not specifically from the Waverley area, and not from outside the Sydney Basin

**Lop or Lopping** - Cutting branches or stems between branch unions or internodes with the final cut leaving a stub

**Low Flows** - Flows generated from rainfall events less than the 1 in 5 year ARI storm event including frequent events.

### M

**Major Alterations and Additions** – Generally, where substantial portions of the existing building are being demolished and/or if the building envelope is being increased by more than 25%.

**Minor Alterations** – Generally, any internal alterations and additions, or external additions which only result in minor increases to the existing building envelope.

**Minor Stormwater System** - A stormwater conveyance system comprising the land formation, pits and pipes, gutters, swales, grated trenches and other stormwater conveyance devices that are used to convey or retain stormwater in storm events up to the 20 year average recurrence interval storm event.

**Mobile Garbage Bin** - A bin on wheels with a lid ('wheely' bin) supplied by Council.

**Mixed Use Development** - As defined in the Waverley Local Environmental Plan.

**Multi Dwelling Housing** – As defined in the Waverley Local Environmental Plan.

**Multi Residential Development**- A building containing one or more dwellings on one lot of land. This may include Mixed Use Development, and other forms of Residential Accommodation.

### N

**Natural Ground Level** - The existing ground level on the site prior to variation by way of excavation or filling, or that level accepted or determined by Council.

**Neighbouring Land** - Any land, which in the opinion of the Authorised Council Officer, may be detrimentally affected by a development application (and may include properties in a neighbouring LGA).

**New Development** – Generally, where a new building or structure is being constructed on site, or where alterations and additions involve significant demolition and redevelopment.

**Non – Habitable Room** - Spaces not occupied frequently or for extended periods.

**North Point** - The orientation of a dwelling or part thereof. A reference to ‘north’ is a reference to true solar north and not magnetic or compass north.

**Noxious weed** - A plant declared noxious under the *Noxious Weeds Act 1993*.

### O

**On-site Detention** - Detention of water on-site (refer to **Detention**).

**On-site Retention** - Retention of water on-site (refer to **Retention**).

**Open Space** - An area external to a building (including an area of land, terrace, balcony or deck) and includes hard paved areas, areas containing swimming pools as well as landscaped area.

**Operational hours** - The hours when a commercial premises is utilised by staff for pre-works and clean up of the premises but is not open to the public for trade.

**Organic Waste** - A biodegradable, compostable wastes of plant and animal origin, such as garden refuse and food wastes capable of being converted into soil conditioners, compost or humus by a biological decay process.

**Origin** - refers to the location of plant material, where seed or cuttings were sourced to produce the plants. These may be:

- Indigenous – plant material from specimens growing in Waverley remnant vegetation or bushland (preferred)
- Local Native – plant material from Eastern Suburbs, Australia (next preference)
- Native – plant material from other region in Australia (Coastal NSW preferred)

**Outbuilding** - An unattached building or structure that includes a bird aviary, cubby house and other play equipment, cabana, garden shed and greenhouse and the like.

**Overland flow** - Runoff from rainfall that flows over the land before entering a watercourse, creek, river, lake or dam. Overland flow can flow down roads, driveways and through homes and buildings. It is typically shallow and fast flowing.

**Overland Flow Path** - The path that stormwater may take if the piped or channelled stormwater system becomes blocked or its capacity exceeded. Overland flow paths provide a fail safe system to ensure that stormwater is not likely to cause flood damage.

**Owner** - The person or persons who appear on Council's computer rates records to be the owner of the land at the date of notification; in the case of land that is the subject of a strata scheme under the *Strata Schemes (Freehold Development) Act 1973*, or a leasehold strata scheme under the *Strata Schemes (Leasehold Development) Act 1986*, the body corporate and each strata unit owner in the case of land that is a community, precinct or neighbourhood parcel within the meaning of the *Community Land Development Act 1989*, the Association for the parcel and each individual owner within the scheme.

## P

**Painted Sign** - A sign painted directly onto an awning fascia and a glass shopfront.

**Parapet** - A wall-like barrier at the edge of a roof, or other structure.

**Parking Space** - Any garage, carport or carspace or court available for use by a vehicle.

**Passive Solar Energy Systems** - Systems which combine the sun's energy with local climate characteristics, to achieve thermal comfort inside buildings without the use of mechanical devices.

**Peak Flows** - The maximum instantaneous outflow from a catchment during a storm event.

**Permeable Paving** - Paving materials that allow infiltration into the soil.

**Permissible Site Discharge** - The maximum discharge from the site during a 1 in 5 year ARI storm event under pre-development (existing) site conditions.

**Pervious** - A surface that permits water to infiltrate into the ground.

**Photovoltaic panels** - A method of generating electrical power by converting solar radiation into direct current electricity.

**Pitched Roof** - A roof having a minimum pitch greater than 10 degrees and a maximum of 35 degrees taken from the horizontal base.

**Pole Sign** - A sign having an area no greater than 3.4m<sup>2</sup>, erected on a pole or pylon independent of any building or other structure. A pole sign is generally used in place of a building whose setback from the street alignment renders it unsuitable for advertising display purposes.

**Porous** - A surface that does allow water to infiltrate into the ground.



**Potable Water** - Water that may be consumed.

**Predominant building line** - The predominant setback of the adjoining properties on the same side of the road as the subject site.

Refer to the definition of building line or setback stated in the dictionary of the Waverley Local Environmental Plan.

**Private Open Space** - Component of open space that is used for private outdoor purposes ancillary to the use of the building and generally relates to rear and side yards and private decks, balconies and courtyards.

**Projecting Wall Sign** - A sign that is attached to a wall of the building (other than the transom of a doorway or display window).

**Prune or pruning** - Activities as specified in *Australian Standards AS 4373 – Pruning of Amenity Trees*:

- crown maintenance pruning involving general pruning or thinning
- deadwooding: the removal of dead wood from a tree
- selective pruning: the removal of identified branches that are causing a specific problem
- formative pruning: selective removal of specific branches to enhance form and improve structure or to directionally shape a young tree
- reduction pruning: reducing the size of the crown of the tree in either height or spread. The ends of branches are removed to internal lateral branches or stems
- crown lifting: the removal of lower branches to specified clearances
- remedial pruning: removing damaged, diseased or lopped branches back to undamaged or healthy tissue
- line clearance: pruning to maintain clearances around overhead services which should involve formative pruning, reduction pruning or remedial pruning

**Public Building** - A building or premises that the public or a section of the public is entitled or allowed to enter or use.

**Public Domain** - All land and facilities open for public use, including open space, streets, lanes, pedestrian thoroughfares, parks and public buildings.

**Probable Maximum Flood (PMF)** - The largest flood that could conceivably occur at a particular location, usually estimated from probable maximum precipitation.

**Probable Maximum Precipitation (PMP)** - The greatest depth of precipitation for a given duration meteorologically possible over a given size storm area at a particular location at a particular time of the year, with no allowance made for long-term climatic trends (World Meteorological Organisation, 1986). It is the primary input to the estimation of the probable maximum flood.

## R

**Recognised Habitat** - means an area or areas occupied, or periodically or occasionally occupied, by a species, population or ecological community and includes any biotic or abiotic component.

**Remnant tree** - A native indigenous tree that remains in the landscape after removal of the majority or all of the native indigenous vegetation in the locality

**Remnant vegetation** - or bushland, is taken to be the original (pre 1788) native vegetation which has survived to this day. It includes both undisturbed and disturbed remnant vegetation. It also includes remnant vegetation which has colonised disturbed areas, where there was no vegetation for a period. The native plants species that grow within these remnants are referred to as indigenous. Remnant vegetation does not include native species that have been planted or introduced to the area.

**Remove** - To cut down, take away or transplant a tree from its place of origin

**Resource Recovery** - To re-use or recycle materials.

**Restaurant** - A building or place, the principal purpose of which is the provision of food or beverages to people for consumption on the premises, whether or not takeaway meals and beverages or entertainment are also provided.

**Restricted Premises** - means premises that, due to their nature, restrict access to patrons or customers over 18 years of age, and includes sex shops and similar premises, but does not include a pub, hotel or motel accommodation, home occupation (sex services) or sex services premises.

**Retention** - The storing of a form of water for beneficial use. Can apply to all forms of water including rainwater, stormwater and recycled water. May occur by storing water in a tank or by infiltration.

**Re-use** - Re-using a product for the same or different purposes without further manufacture, to prolong the original product lifetime.

**Reliable Access** - During a flood means the ability for people to safely evacuate an area subject to imminent flooding within effective warning time, having regard to the depth and velocity of flood waters, the suitability of the evacuation route, and without a need to travel through areas where water depths increase.

**Risk** - The chance of something happening that will have an impact. It is measured in terms of consequences and probability (likelihood).

## S

**Seedbank** - Seeds (especially from remnant vegetation) that has accumulated in the soil, and has the potential to regenerate.

**Setback** - The horizontal distance between a building and a site boundary, measured along a line perpendicular to the site boundary.

**Sex Services** - means sexual acts or sexual services in exchange for payment.

**Sex Services Premises** - means a brothel, but does not include home occupation (sex services).

**Site** - The allotment or group of allotments of land on which a building stands or is proposed to be erected.

**Site Analysis** - The process of identification and analysis of key features of the site and immediate surroundings to assist in understanding how future dwellings will relate to each other and to their locality.

**Soil & Water Management Plan** - Strategies and controls for a development or site to prevent pollution of the environment from all pollutants during the construction stage.

**Solar Collector** - Any building element or appliance specifically designed to capture or collect the sun's rays for the benefit of the occupants including windows to habitable rooms.

**Solid fuel heating** – A heating device that uses solid fuel, such as a fireplace.

**State Significant Development** - Development defined under Section 4.2 of the *EP&A Act 1979*.

**Stormwater** - Rainfall that is concentrated after it runs off all urban surfaces such as roofs, pavements, carparks, roads, gardens and vegetated open space and includes water in stormwater pipes and channels.

**Street frontage** - The street alignment at the front of the lot or building.

**Streetscape** - The character of a locality (whether it be a street or precinct) defined by the spatial arrangement and visual appearance of built and landscape features when viewed from the street.

## T

**Temporary Sign** - An advertisement of a temporary nature that announces any local level event of a religious, educational, cultural, political, social or recreational character or relates to any temporary matter in connection with such an event and does not include advertising of a commercial nature except for the name(s) of an event sponsor, being ancillary to the purpose of the advertisement. Temporary signs may consist of advertisements in the form of banners, bunting, posters and the like.

**Terrace-Style Dwelling** - A dwelling-house that is part of a group of similar dwellings featuring relatively narrow width in relation to depth, attached along their side boundaries and visually similar to other dwellings in the same group, designed as an integral part of that group.

**Third Party Advertising** - Signs whose advertising content is unrelated to the activity of the building or site on which they are positioned, or to the sale or distribution of merchandise from that building or site.

**Top Hamper Sign** - A sign attached above a doorway / window of a building, and is below awning height.

**Top or topping** - The reduction of the height of a tree through lopping.

**Trading Hours** - The hours of when a commercial premises is open for trade to the public.

**Transplant** - The removal of a tree that is excavated from its place of origin within the ground and is relocated within the ground of the same property or re-establishment within the ground or a container within another property.

**Tree** - Any woody perennial plant or any plant resembling a tree greater than 3 metres in height or with a canopy spread greater than 3 metres.

**Tree protection zone** - A specified area above and below ground and at a given distance from the trunk set aside for the protection of a tree's roots and crown to provide for the viability and stability of a tree to be retained where it is potentially subject to damage by development.

## U

**Under Awning Sign** - A sign attached to the underside of an awning.

**Useable Open Space** - An area of open space that is accessible, relatively flat and clear of obstructions and can be used for active or passive recreation

### V

**Virgin excavated natural material** - Natural material (such as clay, gravel, sand, soil or rock fines) that has been excavated from areas that are not contaminated does not contain any sulfidic ores or soils or any other waste.

**Vertically Stacked Parking** - Where one or more vehicles are raised above a parking space by way of a mechanical or hydraulic lift, allowing more than one vehicle to occupy a surface level parking space.

### W

**Wastewater** - is greywater and blackwater.

**Water Sensitive Urban Design** - A design approach promoting sustainable management of the total water cycle through the ecologically sensitive design of homes, streets (and their drainage systems) and whole suburbs.

**Written Notice** - means the written notification letter sent by Council to adjoining and neighbouring land advising of a proposed development.

## ABBREVIATIONS

ABGR	Australian Building Greenhouse Rating Scheme
AHD	Australian Height Datum
AS	Australian Standards
BCA	Building Code of Australia
BJC	Bondi Junction Centre
DA	Development Application
DCP	Development Control Plan
FACS	Family and Community Services
FDM	Floodplain Development Manual
FRMP	Floodplain Risk Management Plan
FRMM	Flood Risk Management Manual
FRMS	Floodplain Risk Management Study
DPE	Department of Planning & Environment
EMR	Electro-Magnetic Radiation
EP&A Act 1979	Environmental Planning and Assessment Act 1979
EPI	Environmental Planning Instrument
FSR	Floor Space Ratio
GBCA	Green Building Council of Australia
GFA	Gross Floor Area
GLA	Gross Leasable Area
LEC	Land and Environment Court
LEP	Local Environmental Plan
LGA	Local Government Area
LVC	Local Village Centre
MGB	Mobile Garbage Bin
OSD	On-site Water Detention
OSR	On-site Water Retention
PA	Planning Agreement
PAPD	Public Art in the Private Domain
PMF	Probable Maximum Flood
PMP	Probable Maximum Precipitation
Regulation 2021	Environmental Planning & Assessment Regulation
RL	Reduced Level
SEE	Statement of Environmental Effects
SWRMP	Site Waste and Recycling Management Plan
TPO	Tree Preservation Order
WAHP	Waverley Affordable Housing Program
WDCCP	Waverley Development Control Plan
WLEP	Waverley Local Environmental Plan 2012
WMTM	Water Management Technical Manual